

Nu:Tekt

OD-S

NUTUBE OVERDRIVE KIT

Owner's Manual
取扱説明書

E J 1

KORG INC. 4015-2 Yanokuchi, Inagi-City, Tokyo 206-0812 JAPAN
©2019 KORG INC. www.korg.com

Table of Contents

Main features	2
Cautions Before Assembly	5
Tools to prepare	5
Checking the parts	5
Assembly Parts List	6
Assembly	7
Adjusting and setting the main circuit board.....	9
Operation Check	9
Troubleshooting	9
Part Names and Functions	10
Specifications	10
Recommended Settings	11
Normal OVERDRIVE	11
Tube OVERDRIVE.....	11
Hard Drive.....	11
Mounting Diagram	13
List of mounted parts	14
CIRCUIT DIAGRAM	16

Thank you for purchasing the Nu:Tekt OD-S NUTUBE OVERDRIVE KIT. To help you get the most out of your new instrument, please read this manual carefully.

Main features

- The Nu:Tekt OD-S is a kit used to assemble effectors that use the Nutube.
- Use the Nutube on the OD-S to get an authentic tube overdrive sound.
- This kit includes a TUBE GAIN knob, which allows you to easily change the distortion waveform.
- Use the internal dipswitch to switch between a full-range overdrive with a full low end and a sparkling high end, and a midrange overdrive sound with plenty of bite, on which the low and high end frequencies are cut off at just the right amount.
- The operational amplifier uses an IC socket, and thus can be easily replaced.
- A machined aluminum die-cast case is included.
- If you are concerned about whether you can assemble this kit or whether you might make a mistake, refer to the video explanations available on the Web (nutekt.org), or use our assembly service support (chargeable).

About Nutube

Nutube is a new vacuum tube developed by KORG INC. and Noritake Itron Corporation and that utilizes technology from vacuum fluorescent displays. As with conventional vacuum tubes, the Nutube is constructed with an anode, grid and filament, and operates as a complete triode tube. Furthermore, it generates the response and same rich harmonic characteristics of conventional vacuum tubes.



If a strong impact is applied to this unit, noise at the high-frequency range may be output. This is due to the structure of the Nutube; it is not a malfunction.

Precautions

Location

Using the unit in the following locations can result in a malfunction.

- In direct sunlight
- Locations of extreme temperature or humidity
- Excessively dusty or dirty locations
- Locations of excessive vibration
- Close to magnetic fields

Power supply

Please connect the designated AC adapter to an AC outlet of the correct voltage. Do not connect it to an AC outlet of voltage other than that for which your unit is intended.

Handling

To avoid breakage, do not apply excessive force to the switches or controls.

Care

If the exterior becomes dirty, wipe it with a clean, dry cloth. Do not use liquid cleaners such as benzene or thinner, or cleaning compounds or flammable polishes.

Keep this manual

After reading this manual, please keep it for later reference.

Keeping foreign matter out of your equipment

Never set any container with liquid in it near this equipment. If liquid gets into the equipment, it could cause a breakdown, fire, or electrical shock.

Be careful not to let metal objects get into the equipment. If something does slip into the equipment, unplug the AC adapter from the wall outlet. Then contact your nearest Korg dealer or the store where the equipment was purchased.

Notice regarding disposal (EU only)



If this symbol is shown on the product, manual, battery, or package, you must dispose of it in the correct manner to avoid harm to human health or damage to the environment. Contact your local administrative body for details on the correct disposal method. If the battery contains heavy metals in excess of the regulated amount, a chemical symbol is displayed below the symbol on the battery or battery package.



IMPORTANT NOTICE TO CONSUMERS

This product has been manufactured according to strict specifications and voltage requirements that are applicable in the country in which it is intended that this product should be used. If you have purchased this product via the internet, through mail order, and/or via a telephone sale, you must verify that this product is intended to be used in the country in which you reside.

WARNING: Use of this product in any country other than that for which it is intended could be dangerous and could invalidate the manufacturer's or distributor's warranty. Please also retain your receipt as proof of purchase otherwise your product may be disqualified from the manufacturer's or distributor's warranty. Company names, product names, and names of formats etc. are the trademarks or registered trademarks of their respective owners.

* All product names and company names are the trademarks or registered trademarks of their respective owners.

Cautions Before Assembly

Be careful of injury when handling parts

Use caution not to injure yourself due to the protruding parts when handling the circuit board. Use cotton work gloves to protect your hands when working. Also, be sure to wash your hands thoroughly after working.

Tighten screws and nuts at a perpendicular angle

Tightening screws and nuts that are inserted diagonally may damage the threads, making it impossible to tighten them again. Be sure to tighten screws so that they are inserted perpendicular to the surface. Use caution, as applying too much torque and tightening the screws too tightly may damage the parts.

Do not injure yourself or scratch the surface with the tools.

When using tools to tighten screws and nuts, make sure not to injure yourself, such as by getting your fingers pinched. Work carefully to avoid scratching the case or circuit board with the tools. Provide a sufficiently large work space to complete the assembly procedure, and prepare work mats so parts will not be scratched.

Avoid losing the screws and nuts

Handle the screws and nuts with caution, to avoid losing them. Do not use other screws or nuts aside from the ones included with this kit, and do not use the screws and nuts included with this kit for any other purpose.

Tools to prepare

You will need the following tools in order to assemble this kit.

Note: You will also need a battery and instrument cables. These items are not included, so please obtain them separately.

- **Needle-nose pliers, tweezers**
- **Phillips head screwdriver (No. 2), precision flathead screwdriver (2.4 mm)**
Use a screwdriver that matches the size of the screw. Using the wrong size of screwdriver may damage the screw or make it impossible to tighten.
- **Spanner, wrench (two-sided, 10 mm/11 mm/14 mm wide)**

Checking the parts

Before assembly, make sure that all parts are on hand. Contact us at nutekt.org if any parts are missing or damaged.

Assembly Parts List

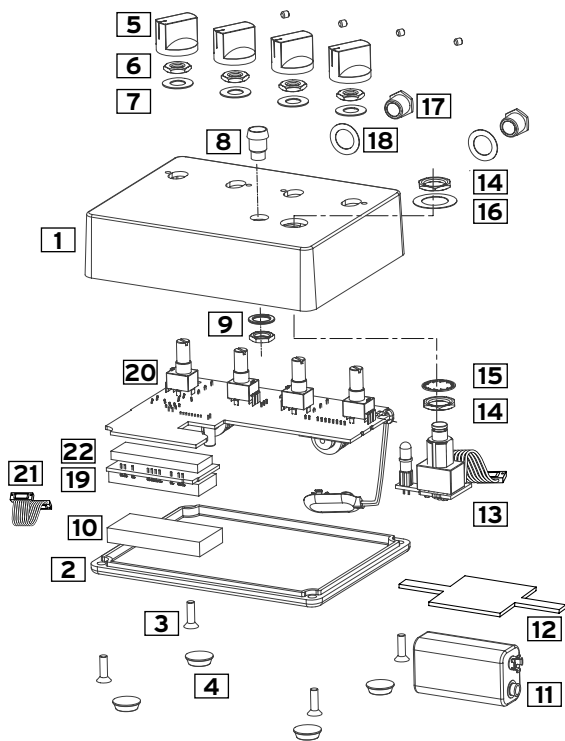

1	Upper case	Aluminum	1
2	Lower case	Aluminum	1
3	Case screws	Flat head screw, M3 x 12	4
4	Rubber feet	Polyurethane 12.7 x 3.6	4
5	Volume knobs	Includes set screws	4
6	Volume nuts	M7, wide 10mm	4
7	Volume washers	7.2 x 12	4
8	LED holder	--	1
9	Washer	Included with LED holder	1
	Nut	Included with LED holder	1
10	Nutube bottom cushion	Sponge 48 x 22 x 7	1
11	Battery (sold separately)	9V alkaline battery (6LF22/6LR61)	--
12	Battery cushion	Sponge 90 x 54 x 2	1
13	Foot switch unit	LED	1
14	Nut	M12, wide 14mm	2
15	Internal tooth lock washer	12.8 x 16 x 0.5	1
16	Washer	12.3 x 16 x 0.5	1
17	Jack nut	Wide 11mm	2
18	Jack washer	10 x 15 x 0.3	2
19	Nutube circuit board unit	--	1
20	Main circuit board	--	1
21	Harness A	Harnesses (8)	1
22	Circuit board cushion	Sponge 45 x 14 x 4	1
23	Rating label	--	1

Tip: Affix the rating label onto the bottom of the case or similar location.

Note: The following parts are included but not used in assembly.

- Parts included with phone jack: Plastic washers (2), fiber washers (2)

Assembly

1. Mount the LED holder [8] onto the upper case [1].

Attach the LED holder [8], and then use the washer and nut to mount the LED holder in place from the back side of the upper case.

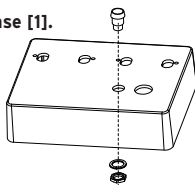

2. Install the main circuit board [20] onto the upper case.

Run the battery snap wires under the main circuit board, making sure that the knot does not loosen.

 If the knot is loose, the battery snap will not be able to reach the battery terminals .

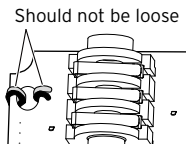

3. Attach the washers [18] for the jack, and temporarily tighten the nuts [17].

Make sure that the positioning tab on the volume control of the main circuit board fits perfectly into the notch on the upper case, and then tighten the nut while holding the jack.

positioning tab

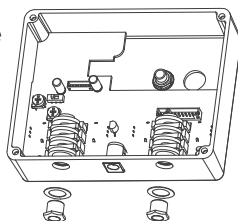

 Be careful not to tighten the nut too hard, so as not to damage the threads on the jack.

4. Attach the washer [7] onto the volume control, and then tighten the nut [6].

After you have finished tightening the volume control nut, retighten the jack nuts [17] that you temporarily tightened.

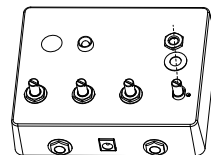

5. Attach the foot switch unit [13] to the upper case [1].

After tightening the nuts [14] on the foot switch unit [13], attach the internal tooth lock washer [15].

Mount the foot switch unit so that its LED fits right into the LED holder mounted on the upper case, and then tighten the foot switch unit using the washer [16] and nuts [14].

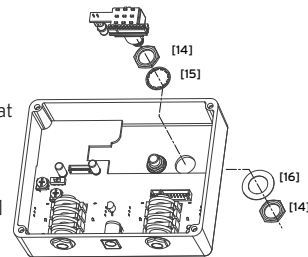

6. Attach the circuit board cushion [22] onto the back side of the Nutube circuit board [19].

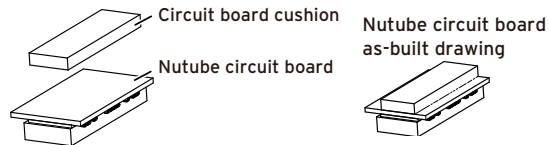

7. Connect the Nutube circuit board [19] and the main circuit board with harness A [21].

8. Mount the Nutube circuit board unit [19].

9. Peel off the release paper on the double-sided tape of the circuit board cushion [22] that was attached to the Nutube circuit board unit [19], and mount the circuit board unit.

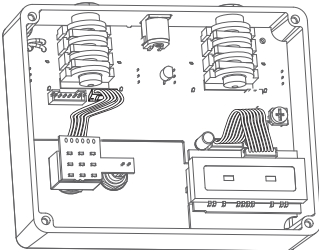

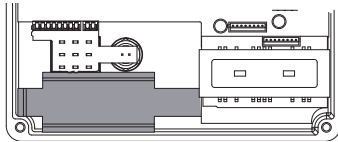

10. Connect the harness of the foot switch unit [13] to the main circuit board.

11. Attach the battery cushion [12] into the battery space.

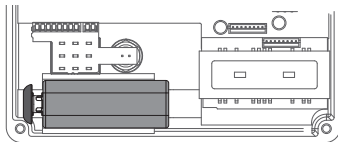

12. Connect the battery [11] and fit it into the battery space.



-  Batteries are not included. You will need to purchase a commercially available 9V alkaline battery (6LF22/6LR61).

13. Adjust the main circuit board.

The board comes preadjusted at the factory, but you can adjust it to your liking by referring to the instructions on "Adjusting and setting the main circuit board," page 9.

14. Close the lower case [2], and secure it with the screws.

After attaching the Nutube bottom cushion [11] onto the inside of the lower case, close the lower case and secure it with the case screws [3] in four places.

-  Take care not to pinch the harness or other parts when closing the case.

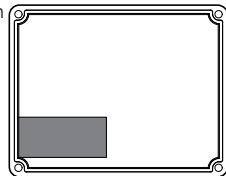

15. Attach the rubber feet [4] onto the lower case.

Attach the rubber feet [4] onto the lower case as shown in the diagram.

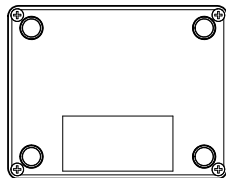

16. Attach the volume knobs [5].

Mount the volume knobs onto their spindles.

- Tip:* The diagram below shows an easy way to position the volume knob when installing.

Indicator faces up Notch on shaft faces flat on its side

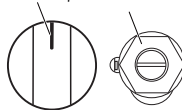

Adjusting and setting the main circuit board

The trimmer potentiometer on the main circuit board adjusts the Nutube bias voltage. Normally, adjust this so that it produces maximum volume.

1. Connect a battery or AC adapter

When using batteries to power this unit, connect a cable to the input jack.

Tip Plugging the cable into the INPUT jack will power the unit.

2. Turn the TUBE GAIN knob up to maximum (all the way to the right).

Set all other knobs to their center positions. Turn the EFFECT switch on.

3. Adjust the trimmer potentiometer on the main circuit board.

Turn the fixed resistor and adjust so that it reaches the maximum volume. The brightness of the Nutube may look different from left to right. This is not a defect.

Tip: The sound quality will change depending on the bias voltage settings. Adjust the settings according to the sound that you like.

4. Set the WIDE switch.

Turn the WIDE switch ON for full-range booster settings. When using the OD-S along with guitar amp distortion, turn the WIDE switch OFF for a more cutting sound. Choose the setting that you like.

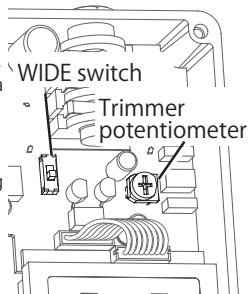

Operation Check

When you have successfully finished assembling the unit, test its operation while reading "Part Names and Functions" on page 10.

If you have found any problems with assembly or operation, use the troubleshooting steps below.

Troubleshooting

There aren't enough parts.

- If you have lost some parts, contact us at nutekt.org.
- Also, contact us at nutekt.org if any parts were missing or damaged before you started to assemble the unit.

I can't assemble the unit, because I broke a part.

- Please contact us at nutekt.org.

The unit makes an abnormal sound when I tilted it or shook it after assembly.

- A loose screw or other part might be left inside the unit. Open the lower case and check the inside.

The volume controls or jacks are loose.

- Make sure that the nuts are fastened tightly. Remove the knobs from the volume controls and retighten the nuts.

Part Names and Functions

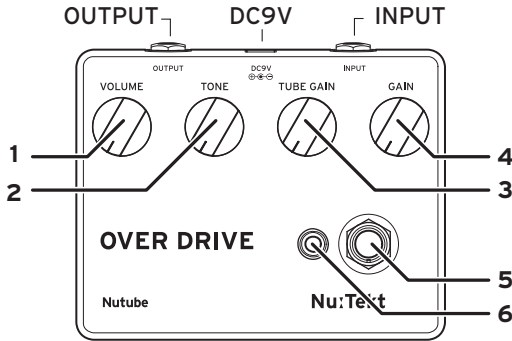

- 1. VOLUME knob:** Adjusts the overall volume.
 - 2. TONE knob:** Turn this knob clockwise for a sharper sound, and counter-clockwise for a more full-bodied sound.
 - 3. TUBE GAIN knob:** By changing the anode resistance value of the Nutube, the distortion waveform will change, letting you enjoy harmonic and distortion changes.
 - 4. GAIN knob:** Used to adjust the amount of distortion.
- Tip:* Flipping the slide switch on the main circuit board to Double will give you a two-series circuit, adding gain and volume.
- 5. EFFECT ON/OFF switch:** Switches the effector on/off.
 - 6. EFFECT ON/OFF LED:** The indicator lights when the effector is on.

Specifications

- **Vacuum tube:** Nutube 6P1
- **Connectors and jacks:** INPUT jack (monaural phone jack), OUTPUT jack (monaural phone jack), DC 9V jack (⊕ ⊖ ⊖)
- **Power:** 9V alkaline battery (6LF22/6LR61) (sold separately), or DC 9V ⊕ ⊖ ⊖ AC adapter (sold separately)
- **Battery life:** Approx. 10 hr. (Using an alkaline battery)
- **Current consumption:** 46 mA
- **Dimensions (W x D x H):** 122 x 96 x 55 mm /4.80" x 3.78" x 2.17"
- **Weight:** 340 g / 12 oz. (without batteries)
- **Included items:** Owner's Manual
- **Accessories (sold separately):** AC adapter (DC 9V ⊕ ⊖ ⊖)

* Specifications and appearance are subject to change without notice for improvement.

Recommended Settings

Normal OVERDRIVE

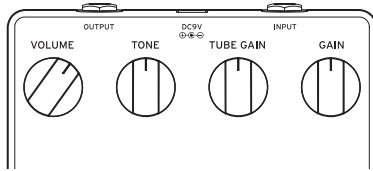

This is a typical overdrive setting.

If you want more of a vacuum tube sound (a milder sound), turn the TUBE GAIN knob to maximum, and adjust the distortion using the GAIN knob.

If you want a harder sound, turn the GAIN knob to maximum, and adjust the distortion using the TUBE GAIN knob.

WIDE  ON
OFF

Tube OVERDRIVE

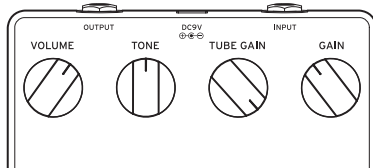

This is a full-range overdrive effect that emphasizes the tube sound.

Turn the WIDE switch on the circuit board ON, and adjust the distortion using the GAIN knob.

WIDE  ON
OFF

Hard Drive

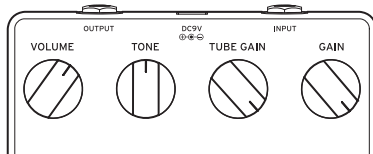

This is a sound with hard distortion.

If your amp is already distorted, turn the GAIN knob lower than the figure.

WIDE  ON
OFF

Mounting Diagram

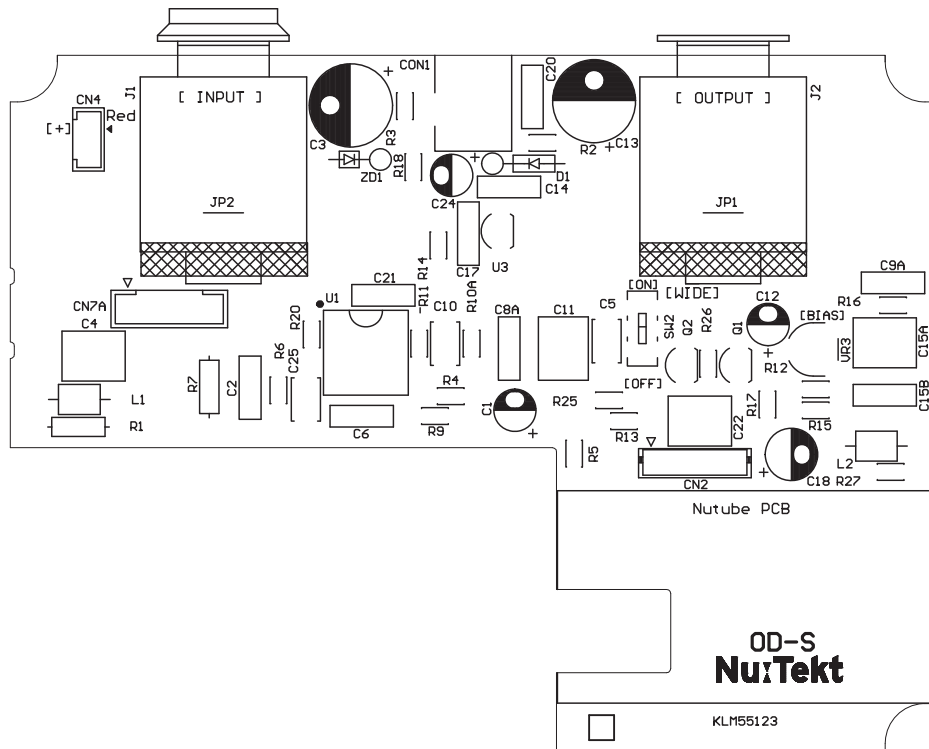

List of mounted parts

Part number	Circuit number	Part name	Rating	Quantity
1	U3	3-terminal regulator	LP2950-33LPRE3	1
2	U1	Operational amplifier	TL072IP	1
3	U1S	Operational amplifier socket	6pin Socket	1
4	Q1, Q2	J-FET	2SK303L-V3-T92-K	2
5	D1	Schottky barrier diode	1S30(R-1)	1
6	ZD1	Zener diode	GDZJ4.7C	1
7	C2	Film capacitor	0.01 μ F	1
8	C6, C9A	Film capacitor	0.1 μ F	1
9	C4, C11, C15A, C22	Film capacitor	1 μ F	4
10	C8A, C15B	Film capacitor	0.047 μ F	1
11	C5	Ceramic capacitor	0.01 μ F	1
12	C14, C17, C20, C21	Ceramic capacitor	0.1 μ F	4
13	C10, C25	Ceramic capacitor	0.1 μ F	1
14	C24	Electrolytic capacitor	47 μ F/16V over	1
15	C1, C12, C23	Electrolytic capacitor	100 μ F/16V over	4
16	C18	Electrolytic capacitor	220 μ F/10V over	2
17	C3, C13	Electrolytic capacitor	330 μ F/25V over	2

Part number	Circuit number	Part name	Rating	Quantity
18	L1, L2	Inductor	WBRH-3.5x5x0.8-U3.7x10	2
19	R20	Resistor	0 Ω	1
20	R2	Resistor	10 Ω	1
21	R3	Resistor	100 Ω	1
22	R18	Resistor	1k Ω	1
23	R4, R5, R6, R16	Resistor	10k Ω	4
24	R14	Resistor	100k Ω	1
25	R11	Resistor	150k Ω	3
26	R26	Resistor	220k Ω	2
27	R17	Resistor	75 Ω	2
28	R1, R7	Resistor	2M Ω	2
29	R15, R27	Resistor	2.4k Ω	2
30	R13, R25	Resistor	33k Ω	2
31	R10A	Resistor	4.7k Ω	1
32	R9	Resistor	51k Ω	1
33	R12	Resistor	6.8k Ω	1
34	CN7B	Board-in harness	6	1
35	CN7A	Connectors	B6B-PH-K-S	1
36	CN1, CN2	Connectors	B8B-ZR-3.4	2
37	CON1	DC jack	LD-0202AH-2.0-03A	1
38	J1, J2	Phone jack	LJB0664-6	2
39	SW2	Dip switch	IS-2235-G	1

Part number	Circuit number	Part name	Rating	Quantity
40	V1	Nutube (vacuum tube)	Nutube 6P1	1
41	VR1, VR5	Volume control	10K A	2
42	VR2	Volume control	100K A	1
43	VR3	Trimmer Potentiometer	10K B	1
44	VR4	Volume control	500K B	1
45	CN4	Battery snap	--	1

Note: An electrolytic capacitor with a higher rated voltage than the voltage specified may have been used.

CIRCUIT DIAGRAM

