

FSR 1U

Force Sensing CV and Gate Generating Pad

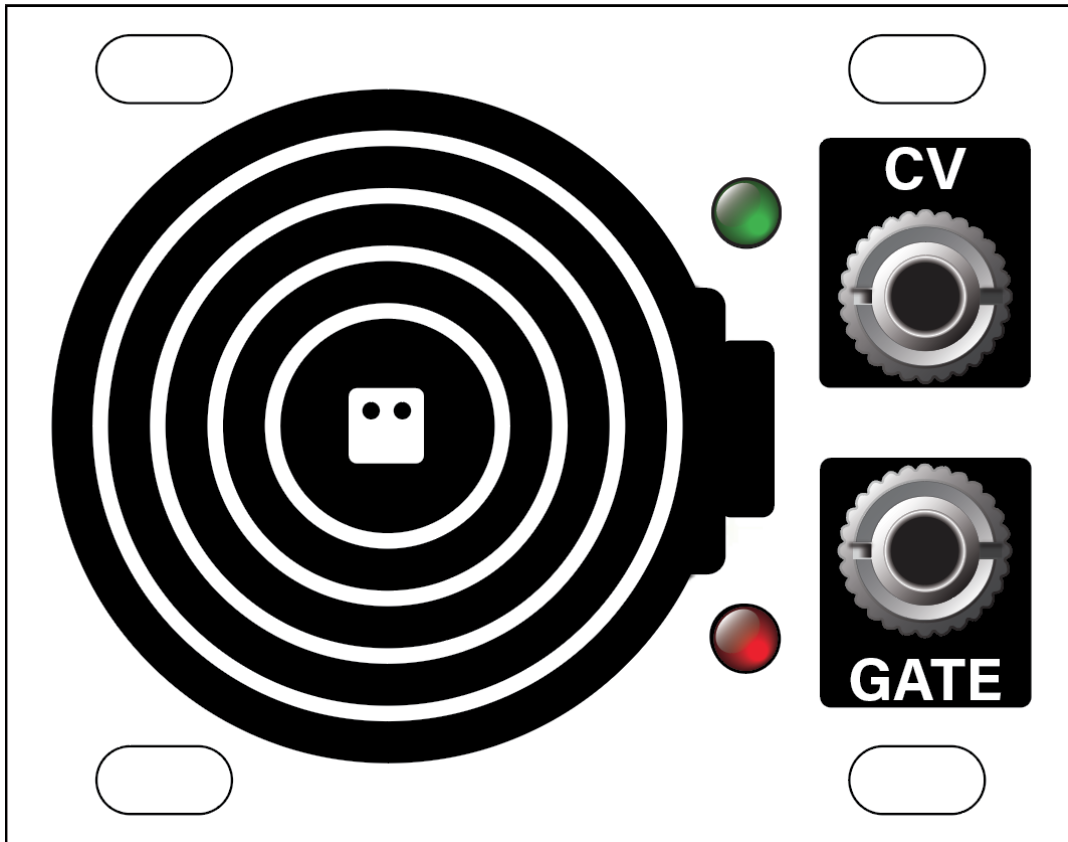

Table of Contents

[Compliance](#)

[Installation](#)

[Before Your Start](#)

[Installing Your Module](#)

[Front Panel](#)

[Controllers & LEDs](#)

[Inputs & Outputs](#)

[Technical Specifications](#)

Compliance



This device complies with Part 15 of the FCC Rules. Operation is subject to the following two conditions: (1) this device may not cause harmful interference, and (2) this device must accept any interference received, including interference that may cause undesired operation.

Changes or modifications not expressly approved by Intellijel Designs, Inc. could void the user's authority to operate the equipment.

Any digital equipment has been tested and found to comply with the limits for a Class A digital device, pursuant to part 15 of the FCC Rules. These limits are designed to provide reasonable protection against harmful interference when the equipment is operated in a commercial environment. This equipment generates, uses, and can radiate radio frequency energy and, if not installed and used in accordance with the instruction manual, may cause harmful interference to radio communications.



This device meets the requirements of the following standards and directives:

EMC: 2014/30/EU

EN55032:2015 ; EN55103-2:2009 (EN55024) ; EN61000-3-2 ; EN61000-3-3

Low Voltage: 2014/35/EU

EN 60065:2002+A1:2006+A11:2008+A2:2010+A12:2011

RoHS2: 2011/65/EU

WEEE: 2012/19/EU

Installation

This module is designed for use within an Intellijel-standard 1U row, such as contained within the Intellijel 4U and 7U Eurorack cases. Intellijel's 1U specification is derived from the Eurorack mechanical specification set by Doepfer that is designed to support the use of lipped rails within industry standard rack heights.

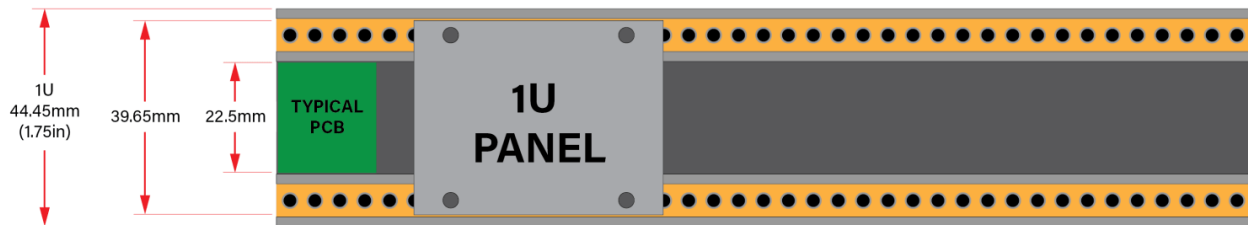
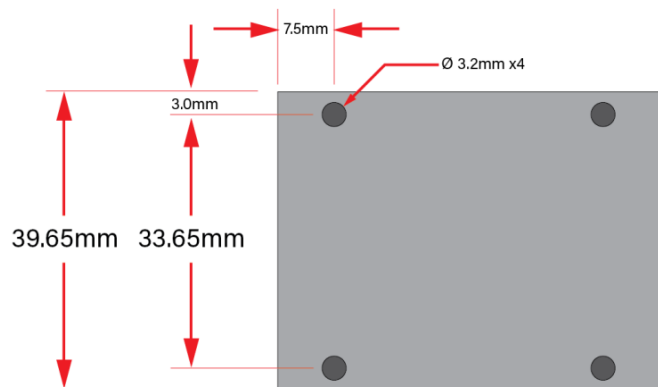

Before Your Start

Intellijel Eurorack modules are designed to be used with a Eurorack-compatible case and power supply. We recommend you use Intellijel cases and power supplies.

Before installing a new module in your case, you must ensure your power supply has a free power header and sufficient available capacity to power the module:

- Sum up the specified +12V current draw for all modules, including the new one. Do the same for the -12 V and +5V current draw. The current draw will be specified in the manufacturer's technical specifications for each module.
- Compare each of the sums to specifications for your case's power supply.
- Only proceed with installation if none of the values exceeds the power supply's specifications. Otherwise you must remove modules to free up capacity or upgrade your power supply.

You will also need to ensure your case has enough free space (hp) to fit the new module. To prevent screws or other debris from falling into the case and shorting any electrical contacts, not leave gaps between adjacent modules, and cover all unused areas with blank panels. Similarly, do not use open frames or any other enclosure that exposes the backside of any module or the power distribution board.

You can use a tool like [ModularGrid](#) to assist in your planning. Failure to adequately power your modules may result in damage to your modules or power supply. If you are unsure, please [contact us](#) before proceeding.

Installing Your Module

When installing or removing a module from your case always turn off the power to the case and disconnect the power cable. Failure to do so may result in serious injury or equipment damage.

Ensure the 10-pin connector on the power cable is connected correctly to the module before proceeding. The red stripe on the cable must line up with the -12V pins on the module's power connector. Different modules use different ways to indicate the -12V pins. Some may be labelled with "-12V;" a white stripe next to the -12V pins; the words "red stripe;" or some combination of these. Additionally, some modules may have shrouded headers, thus preventing backward connections.

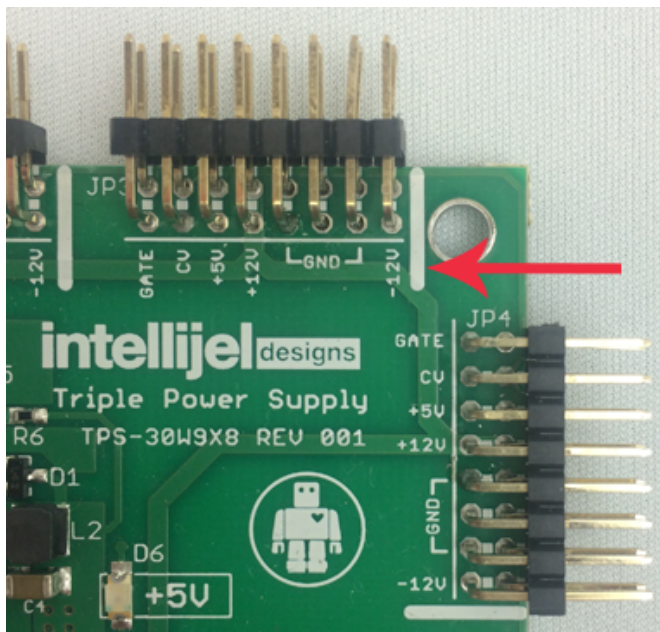
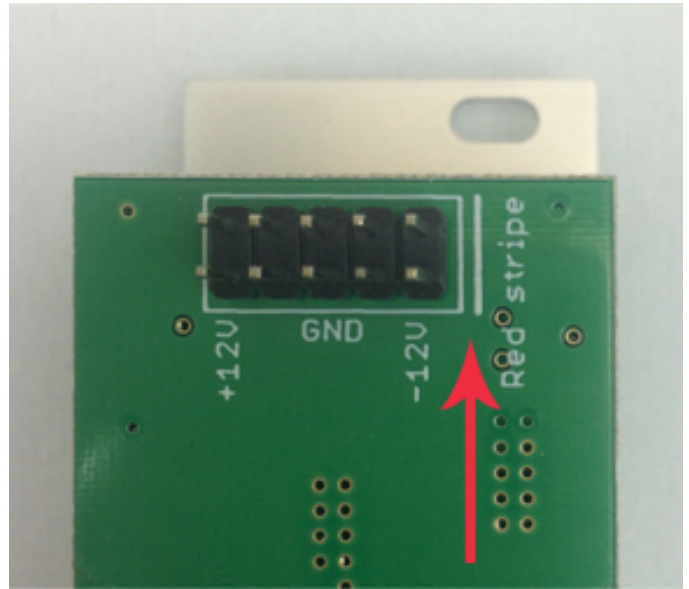

Most modules will come with the cable already connected but it is good to double check the orientation. Be aware that some modules may have headers that serve other purposes so ensure the power cable is connected to the right one.

The other end of the cable, with a 16-pin connector, connects to the power bus board of your Eurorack case. Ensure the red stripe on the cable lines up with the -12V pins on the bus board. On Intellijel power supplies the pins are labelled with the label "-12V" and a thick white stripe:

If you are using another manufacturer's power supply, check their documentation for instructions.

Once connected, the cabling between the module and power supply should resemble the picture below:

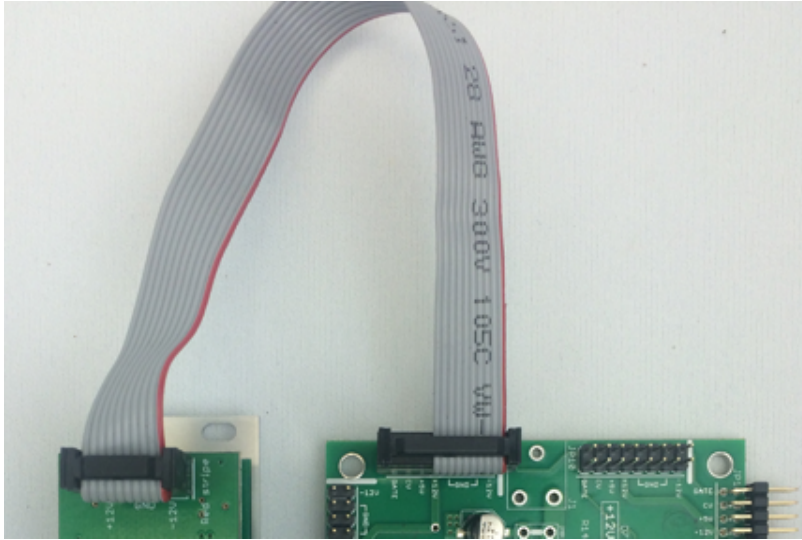

Before reconnecting power and turning on your modular system, double check that the ribbon cable is fully seated on both ends and that all the pins are correctly aligned. If the pins are misaligned in any direction or the ribbon is backwards you can cause damage to your module, power supply, or other modules.

After you have confirmed all the connections, you can reconnect the power cable and turn on your modular system. You should immediately check that all your modules have powered on and are functioning correctly. If you notice any anomalies, turn your system off right away and check your cabling again for mistakes.

After you have confirmed all the connections, you can reconnect the power cable and turn on

Front Panel

Controllers & LEDs

- A. FSR** - The surface of the force sensing resistor is both touch and pressure sensitive.

Touching it sends a +5V signal to the **GATE [2]** output for as long as your finger sits on the pad.

Pressing it sends a voltage to the **CV Out [1]**, whose value corresponds with the amount of pressure you apply. At maximum pressure, +5V volts is sent to the **CV Out [1]** jack.

The pad is very sensitive and offers a great deal of nuanced, real-time control.

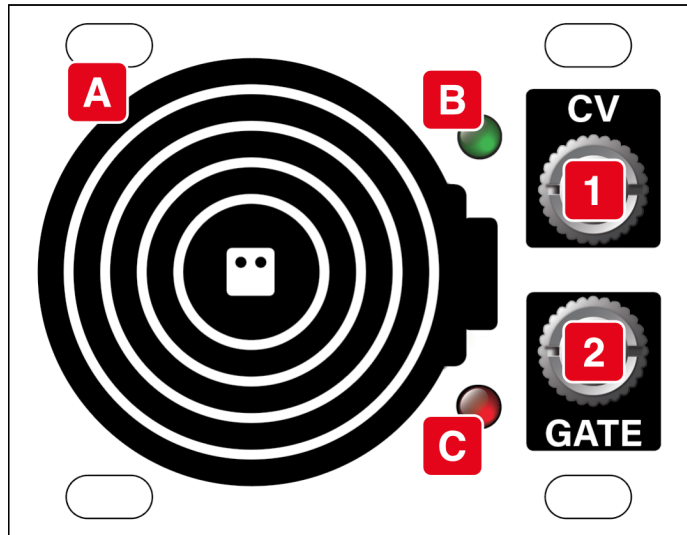

- B. CV LED** - This LED begins to glow when the **FSR [A]** is being touched, and gets brighter as more pressure (and thus more voltage) is being sent to the **CV Out [1]** jack.
- C. GATE LED** - This LED lights when the **FSR [A]** is being touched and a +5V gate signal is being sent out the **GATE [2]** jack.

Inputs & Outputs

- 1. CV out** - This jack outputs a voltage that corresponds to the pressure with which you press on the **FSR [A]**. Pressing very lightly sends voltages near 0V. Maximum pressure outputs +5V.
- 2. GATE out** - This jack outputs +5V gate signal for as long as the **FSR [A]** is touched, returning to 0V when you lift your finger off the pad.

Technical Specifications

Width	10 hp
Maximum Depth	23 mm
Current Draw	24 mA @ +12V 9 mA @ -12V