

# Duatt 1U

Dual Attenuator / Inverter / Attenuverter / Multiplier / Mixer / DC Voltage Source

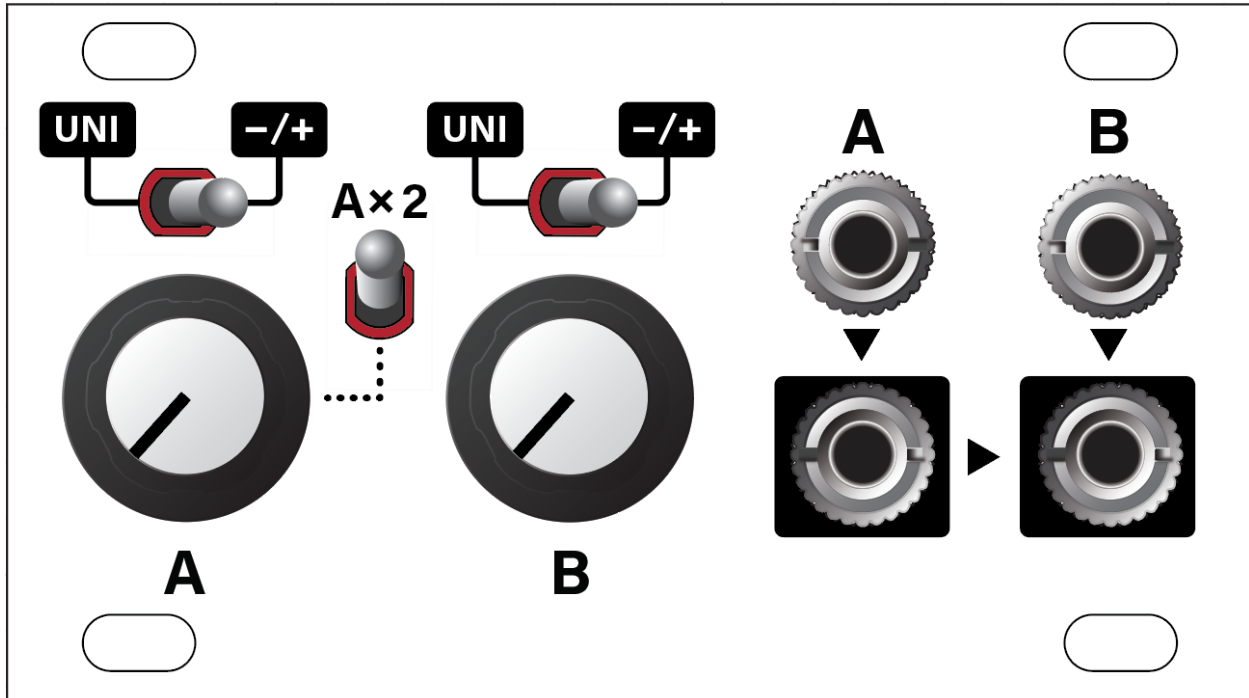

## Table of Contents

[Compliance](#)

[Installation](#)

[Before Your Start](#)

[Installing Your Module](#)

[Front Panel](#)

[Controllers](#)

[Inputs & Outputs](#)

[Usage Examples](#)

[Technical Specifications](#)

## Compliance



This device complies with Part 15 of the FCC Rules. Operation is subject to the following two conditions: (1) this device may not cause harmful interference, and (2) this device must accept any interference received, including interference that may cause undesired operation.

Changes or modifications not expressly approved by Intellijel Designs, Inc. could void the user's authority to operate the equipment.

Any digital equipment has been tested and found to comply with the limits for a Class A digital device, pursuant to part 15 of the FCC Rules. These limits are designed to provide reasonable protection against harmful interference when the equipment is operated in a commercial environment. This equipment generates, uses, and can radiate radio frequency energy and, if not installed and used in accordance with the instruction manual, may cause harmful interference to radio communications.



This device meets the requirements of the following standards and directives:

EMC: 2014/30/EU

EN55032:2015 ; EN55103-2:2009 (EN55024) ; EN61000-3-2 ; EN61000-3-3

Low Voltage: 2014/35/EU

EN 60065:2002+A1:2006+A11:2008+A2:2010+A12:2011

RoHS2: 2011/65/EU

WEEE: 2012/19/EU

## Installation

This module is designed for use within an Intellijel-standard 1U row, such as contained within the Intellijel 4U and 7U Eurorack cases. Intellijel's 1U specification is derived from the Eurorack mechanical specification set by Doepfer that is designed to support the use of lipped rails within industry standard rack heights.

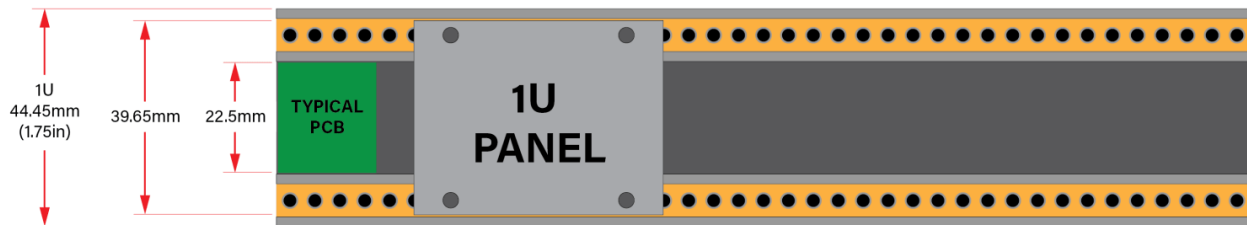
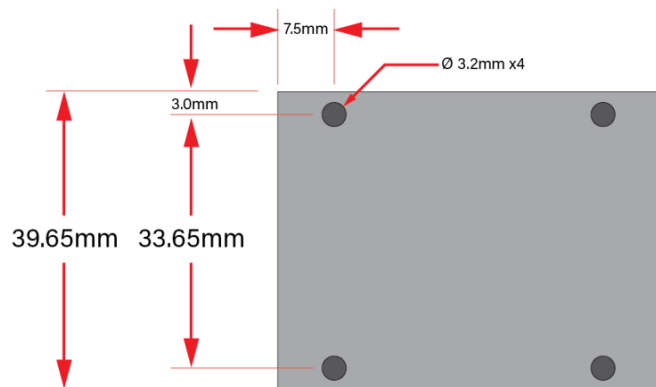

## Before Your Start

Intellijel Eurorack modules are designed to be used with a Eurorack-compatible case and power supply. We recommend you use Intellijel cases and power supplies.

Before installing a new module in your case, you must ensure your power supply has a free power header and sufficient available capacity to power the module:

- Sum up the specified +12V current draw for all modules, including the new one. Do the same for the -12 V and +5V current draw. The current draw will be specified in the manufacturer's technical specifications for each module.
- Compare each of the sums to specifications for your case's power supply.
- Only proceed with installation if none of the values exceeds the power supply's specifications. Otherwise you must remove modules to free up capacity or upgrade your power supply.

You will also need to ensure your case has enough free space (hp) to fit the new module. To prevent screws or other debris from falling into the case and shorting any electrical contacts, not leave gaps between adjacent modules, and cover all unused areas with blank panels. Similarly, do not use open frames or any other enclosure that exposes the backside of any module or the power distribution board.

You can use a tool like [ModularGrid](#) to assist in your planning. Failure to adequately power your modules may result in damage to your modules or power supply. If you are unsure, please [contact us](#) before proceeding.

## Installing Your Module

When installing or removing a module from your case always turn off the power to the case and disconnect the power cable. Failure to do so may result in serious injury or equipment damage.

Ensure the 10-pin connector on the power cable is connected correctly to the module before proceeding. The red stripe on the cable must line up with the -12V pins on the module's power connector. Different modules use different ways to indicate the -12V pins. Some may be labelled with "-12V;" a white stripe next to the -12V pins; the words "red stripe;" or some combination of these. Additionally, some modules may have shrouded headers, thus preventing backward connections.

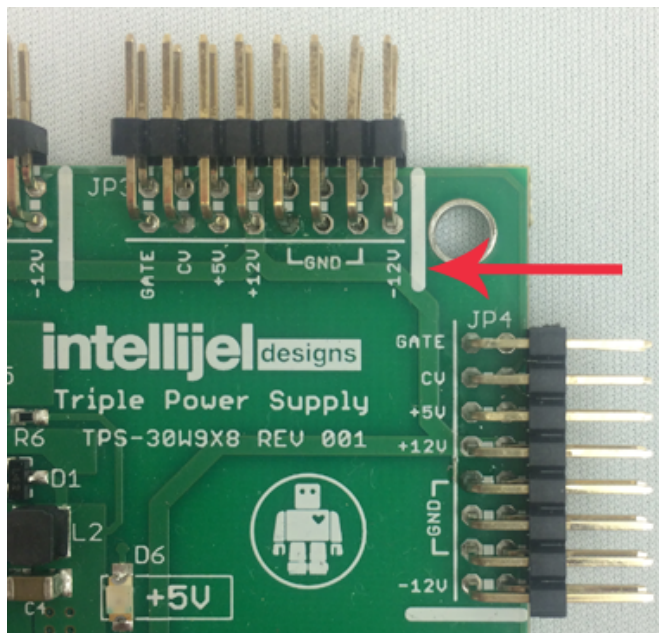
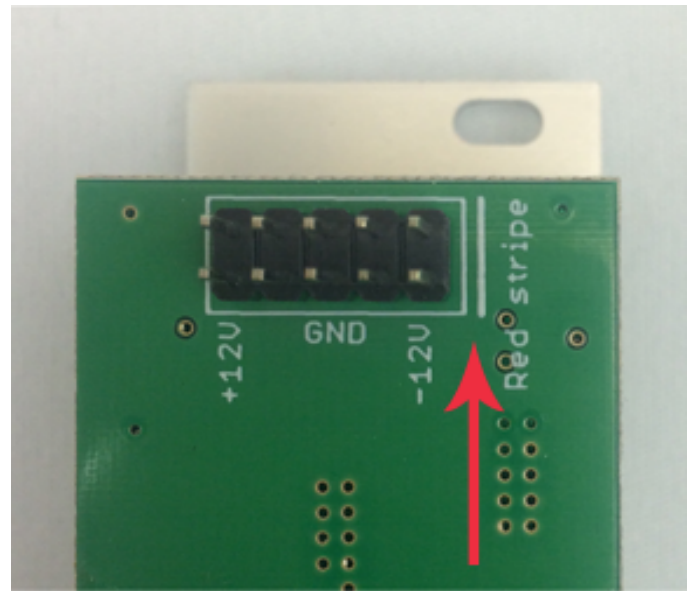

Most modules will come with the cable already connected but it is good to double check the orientation. Be aware that some modules may have headers that serve other purposes so ensure the power cable is connected to the right one.

The other end of the cable, with a 16-pin connector, connects to the power bus board of your Eurorack case. Ensure the red stripe on the cable lines up with the -12V pins on the bus board. On Intellijel power supplies the pins are labelled with the label "-12V" and a thick white stripe:

If you are using another manufacturer's power supply, check their documentation for instructions.

Once connected, the cabling between the module and power supply should resemble the picture below:

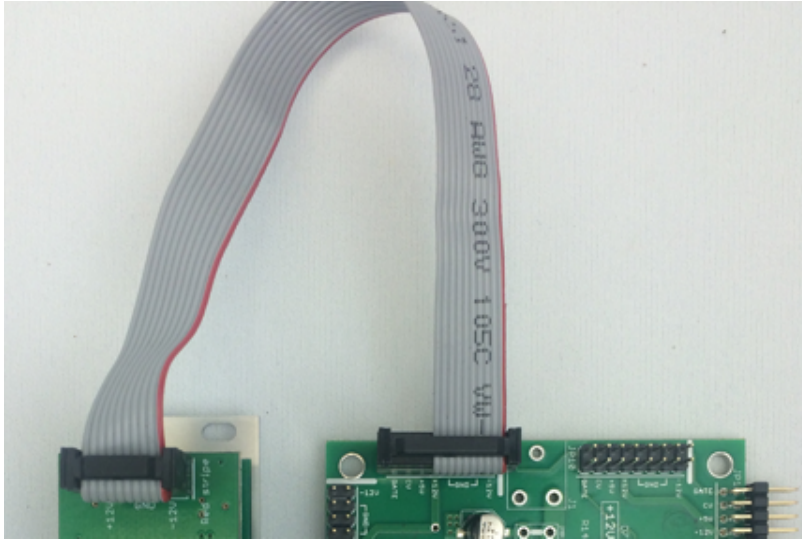

Before reconnecting power and turning on your modular system, double check that the ribbon cable is fully seated on both ends and that all the pins are correctly aligned. If the pins are misaligned in any direction or the ribbon is backwards you can cause damage to your module, power supply, or other modules.

After you have confirmed all the connections, you can reconnect the power cable and turn on your modular system. You should immediately check that all your modules have powered on and are functioning correctly. If you notice any anomalies, turn your system off right away and check your cabling again for mistakes.

After you have confirmed all the connections, you can reconnect the power cable and turn on

## Front Panel

### Controllers

#### 1. Channel attenuator (x2)

These knobs linearly attenuate the voltage present at the input **[A or B]** of each channel. If no voltage is present at the input, the knobs attenuate a +5V DC voltage.

The **Channel Polarity Switch [2]** determines the range and behaviour of the knob.

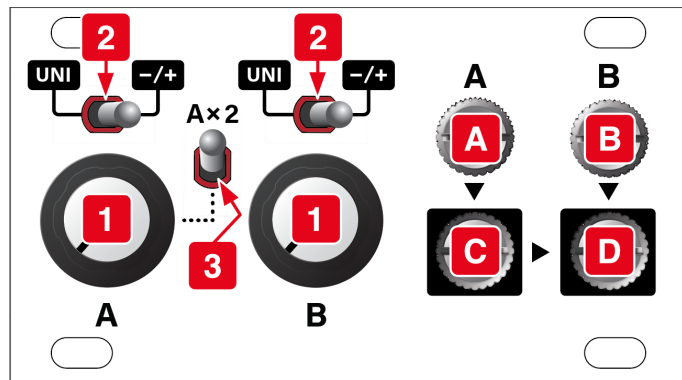

#### 2. Channel Polarity Switch (x2)

This switch sets the polarity of the signal sent to the output **[C or D]** of each channel.

**UNI:** With the switch in the left **UNI** position, the corresponding **Channel Attenuator Knob [1]** functions as a standard attenuator. The full value of the channel's input voltage (or +5V DC, if the input is unpatched) passes through to the output when the knob is fully clockwise. None of the voltage (0 V) passes to the output with the knob fully counterclockwise; and half the voltage passes through when the knob is at the 'noon' position.

**-/+:** With the switch in the right **-/+** position, the corresponding **Channel Attenuator Knob [1]** acts as a bipolar attenuverter. The full value of the channel's input voltage (or +5V DC, if the input is unpatched) passes through to the output when the knob is fully clockwise. The inverse of the input voltage is sent to the output when the knob is fully counterclockwise; and none of the input voltage (0 V) passes through to the output when the knob is at the 'noon' position.

#### 3. Ax2 switch

In the up (on) position, this switch doubles the voltage appearing at Channel A's input **[A]**.

For example: leave the input of Channel A unconnected; set its channel's polarity switch to **-/+**, turn its channel attenuator fully clockwise; and set the **Ax2** switch to the down (off) position. Duatt will internally send 5V to Channel A's input. Flip the **Ax2** switch to the up (on) position, and Duatt sends 10V (5V x 2) to Channel A's input. Rotate the knob fully counterclockwise, and Duatt sends -10V (-5V x 2) to Channel A's input.

The **Ax2** switch is a convenient way to double the input voltage, or to set a full +10V or -10V DC offset to the signal patched into Channel B.

## Inputs & Outputs

### A. IN A

Input for Channel A. The voltage sent to this input is doubled (multiplied by 2) if the **Ax2** switch **[3]** is on (up).

With no cable plugged in, Duatt sends a 5V DC voltage into Channel A, which you can double to 10V (5V x 2) with the **Ax2** switch on. This input voltage can then be inverted with the polarity switch and scaled with Channel A's attenuator knob.

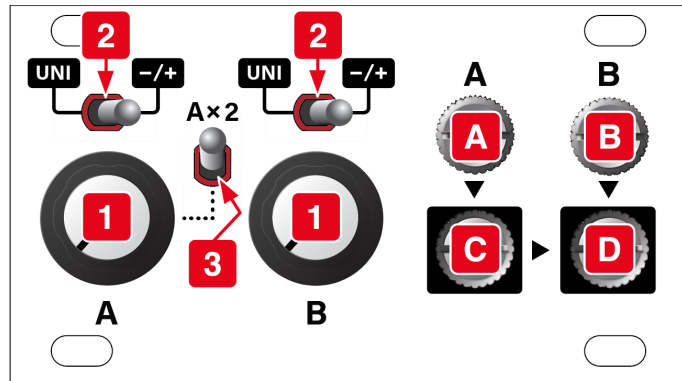

### B. IN B

Input for Channel B.

With no cable plugged in, Duatt sends a 5V DC voltage into Channel B. The input voltage can be inverted with the polarity switch and scaled with Channel B's attenuator knob.

### C. OUT A

Output for Channel A. If nothing is plugged into **OUT A [C]**, then its voltage is bussed to Channel B and summed with its output voltage. Plugging a cable into **OUT A** prevents it from being summed with Channel B's output **[D]**.

### D. OUT B

Output for Channel B. If nothing is plugged into **OUT A [C]**, then **OUT B [D]** contains the sum of Channel A and Channel B's output voltages.



---

## Usage Examples

These simple parameters provide a wealth of useful functions to the modular synthesist. Here are some basic examples of how you might employ Duatt 1U in your patches:

- **Attenuation:** Assume you want to *subtly* modulate filter resonance, but your filter of choice doesn't have a built-in attenuator on its resonance CV input. If you were to plug the output of your LFO directly into the resonance CV input on your filter, you'd be modulating it at full amplitude — meaning your LFO would cycle the resonance from “none” to “ear shattering squelch” and back again. But what if you just want resonance to undulate a little bit? Duatt 1U to the rescue!

Plug the output of your LFO into Duatt's **IN A**, then plug **OUT A** into your filter's resonance CV jack. You'll now be able to “dial down” the peak-to-peak amplitude of the LFO using Duatt's attenuator knob.

- **Inversion:** Assume you want to control a module with an envelope. Normally, voltage increases during the attack section of an ADSR, then decreases during the decay and release segments. But what if you want the inverse? What if you want some sonic attribute to get *more* pronounced as the signal decays, not less? For this you need to invert the envelope. Once again, Duatt's on the case!

Plug the output of your envelope into Duatt's **IN A**, set Channel A's polarity switch to **-/+**, then turn its attenuator knob *counterclockwise* past 12:00 — an inverted envelope now appears at Duatt's **OUT A**.

- **Voltage Offsets:** Assume you have a Sample & Hold module sending random notes to an oscillator, only you want to constrain that unruly 10 octave range of notes to just one or two octaves in the bass range. One way to do this is to use both Duatt channels.

Plug your S&H output into Duatt's **IN B**; connect **OUT B** to your oscillator's pitch input; then use the Channel B attenuator to limit the range of notes to an octave or two. Next, use Duatt's Channel A (into which nothing is connected) to negatively offset the note range down into the bass frequencies. Do this by setting Channel A's polarity switch to **-/+**, then turn the corresponding attenuator knob *counterclockwise* past 12:00. Because nothing is plugged into Duatt's **OUT A**, **OUT B** contains a sum of Channels A and B, giving you both the reduced note range and the lower frequencies you desire.

- **CV Mixing:** What if you want to modulate some parameter with more than one control voltage at a time? Perhaps you want to send a square wave to modulate a filter's cutoff frequency giving it a steady “pulsing” sound while simultaneously sweeping it with a slow, triangular LFO. Duatt's got you covered. And, once again, you'll be using two channels.

Plug the square wave output of the “pulsing” LFO into Duatt’s **IN A** and connect **OUT B** to your filter’s frequency CV input. Use Channel A’s attenuverter to set the amount of pulse you want to hear. Next, plug the triangle wave output of the “slow sweeping” LFO into Duatt’s **IN B**. Since nothing is plugged into **OUT A**, **OUT B** contains a sum of Duatt’s A and B channels. Use Channel B’s attenuverter to set how much the pulse sweeps up and down the frequency band. You now have two different CV sources controlling one destination by varying amounts.

- **Audio Mixing:** Audio is a voltage too. So you’re probably asking yourself, “Can I use Duatt to mix a couple channels of audio together?” Yes, you can!

Set both of Duatt’s polarity switches to **UNI** and turn both its knobs fully *counterclockwise*. Plug the output of one oscillator into **IN A**, and the other into **IN B**. Connect **OUT B** to your audio amplifier, and leave **OUT A** un-connected. Rotate Channel A’s attenuator clockwise and you’ll hear the oscillator connected to **IN A**. Increase the Channel B attenuator to add **IN B** to the mix.

- **Instant Voltage Doubling:** Channel A has a dedicated multiplier switch, which doubles the voltage being sent to its input. This is ideal for temporarily pumping up a CV’s impact on a particular parameter, then instantly dropping it back down to its original level.

## Technical Specifications

Width	14 hp
Maximum Depth	22 mm
Current Draw	12 mA @ +12V 10 mA @ -12V