

MOOER

OCEAN MACHINE

Premium Dual Delay, Reverb and Looper pedal

Owner's Manual

Precautions

PLEASE READ CAREFULLY BEFORE PROCEEDING

Power Supply

Please connect the designated AC adapter to an AC outlet of the correct voltage. Please be sure to use only an AC adapter which supplies 9V DC ($\pm 10\%$), $\oplus \text{---} \ominus$, center negative. Unplug the AC power adapter when not in use or during electrical storms.

Connections

Always turn off the power of this and all other equipment before connecting or disconnecting, this will help prevent malfunction and / or damage to other devices. Also make sure to disconnect all connection cables and the power cord before moving this unit.

Cleaning

Clean only with a soft, dry cloth. If necessary, slightly moisten the cloth. Do not use abrasive cleanser, cleaning alcohol, paint thinners, wax, solvents, cleaning fluids, or chemical-impregnated wiping cloths.

Interference with other electrical devices

Radios and televisions placed nearby may experience reception interference.

Operate this unit at a suitable distance from radios and televisions.

Location

To avoid deformation, discoloration, or other serious damage, do not expose this unit to the following conditions:

- Direct sunlight
- Heat sources
- Magnetic fields
- Extreme temperature or humidity
- Excessive dusty or dirty location
- High humidity or moisture
- Strong vibrations or shocks

FCC certification

This device complies with Part 15 of the FCC Rules. Operation is subject to the following two conditions:

- This device may not cause harmful interference.
- This device must accept any interference received, including interference that may cause undesired operation.

Contents

Panel Layout	01
Front Panel Layout	01
Back Panel Layout	02
Setup	03
Modes	04
Play Mode	05
Patch Mode	07
Effect Types	09
Reverb	09
Delay B	09
Delay A	10
Expression pedal	10
Looper	11
Settings Menu	13
Wireless	13
Exp.	14
Tone	14
Merge	15
Midi Mapping	15
Trail	15
IN & OUT	16
Global EQ	16
Reset	17
Storing Presets	17
Wireless Footswitch	18
MIDI	19
Firmware Update	22

Panel Layout

Front Panel Layout

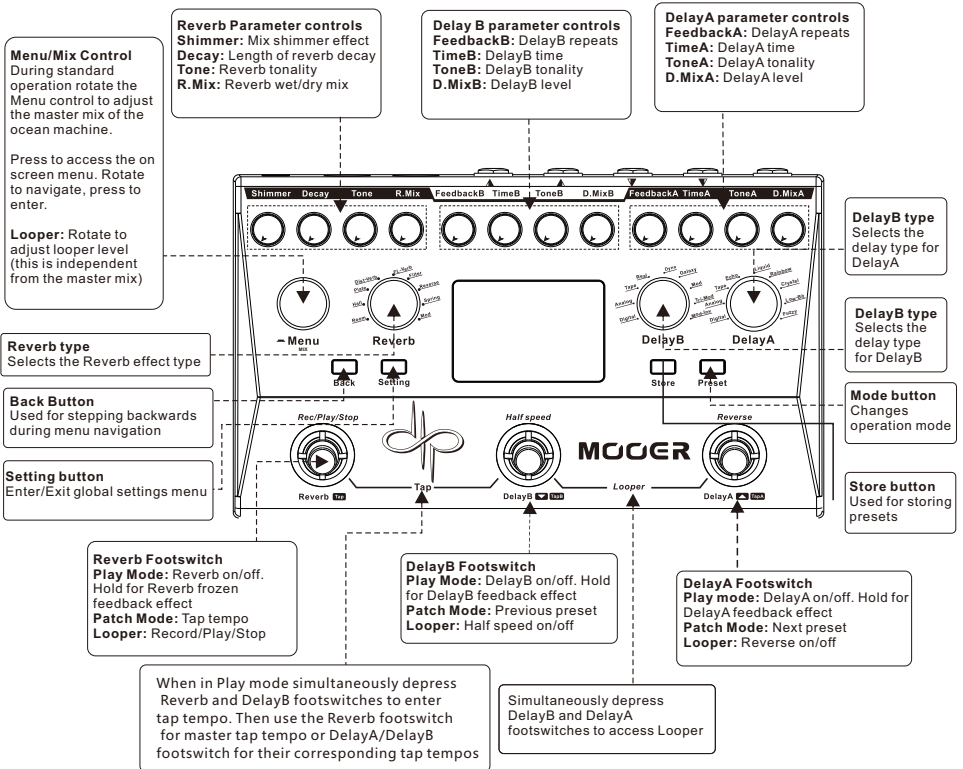

Back Panel Layout

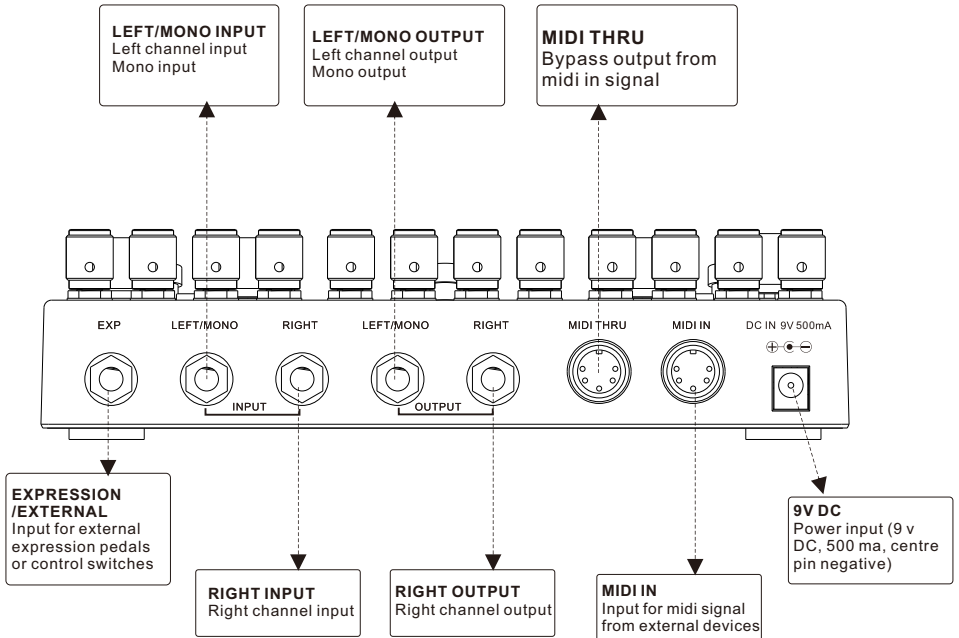

Setup

Front of amp

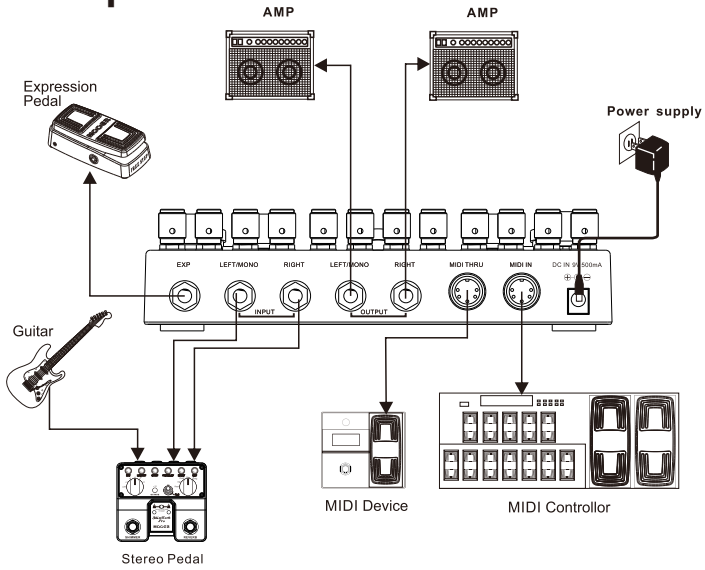

FX Loop

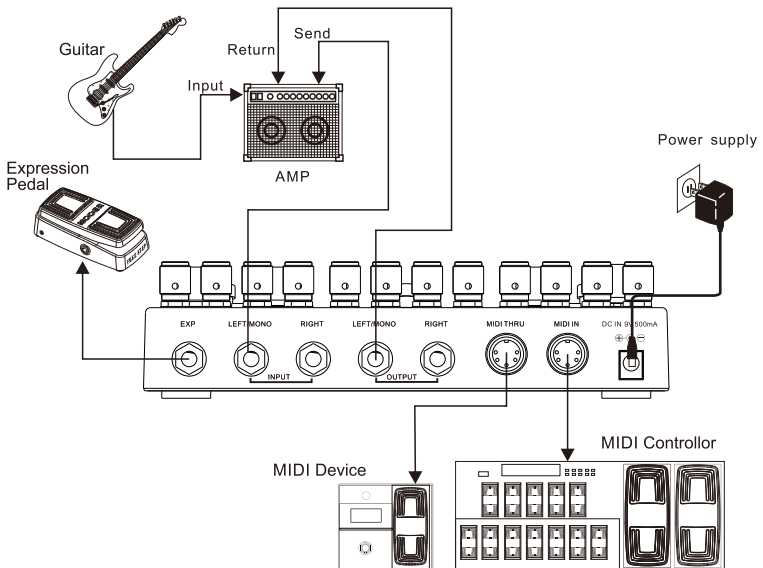

Modes

The Ocean Machine has two main operation modes to allow the device to be used in different ways.

PLAY Mode - In this mode the Ocean machine operates like a tradition effects pedal and every basic effect parameter value is the same as that of it's corresponding control knob.

PATCH Mode - In this mode the Ocean machine recalls saved presets and all basic effect parameter values will be the same as the recalled preset until adjusted via their corresponding control knob.

Press the **Preset** button to change the mode of operation.

Play Mode

Ocean Machine will boot directly to Play mode by default when powered on. In this mode the ocean machine will operate like a traditional stompbox. All basic effect parameters are depicted directly by the values of the physical control knobs.

Footswitch and control functions

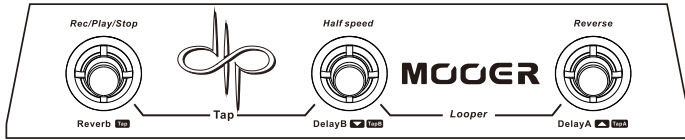

Reverb/DelayB/DelayA

Depressing any of these footswitches once will turn on or turn off it's respective effect. Holding down any of these footswitches while it's respective effect is turned on will put the effect into a state of infinite feedback until the footswitch is released.

TAP Tempo

Simultaneously depress the **Reverb** and **DelayB** footswitches to access tap tempo control. You will then have a few seconds to tap your desired tempo.

Reverb footswitch = master tap tempo

Delay B footswitch = Delay B tempo

Delay A footswitch = Delay A tempo

Auto sub-division values can be set for each delay separately in the menu screen.

Effect Parameters

All of the basic effect parameters can be adjusted directly using their respective control knobs. More effect parameters, tempo sub-divisions, ping pong, effects chain, etc. can all be edited and adjusted within the menu screen.

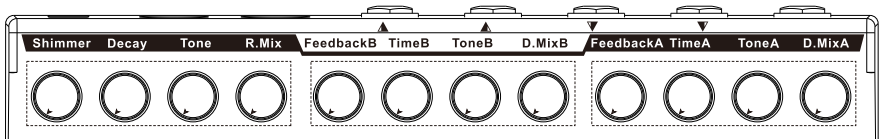

Master Mix



Rotate the Menu control when nothing is selected within the menu screen to adjust the master output effect mix of the ocean machine.

Menu Screen

The menu screen allows access to deeper editing options. To access the menu screen options press the Menu control knob once.

When inside the menu screen the currently selected effect block or parameter will be highlighted with a red border.

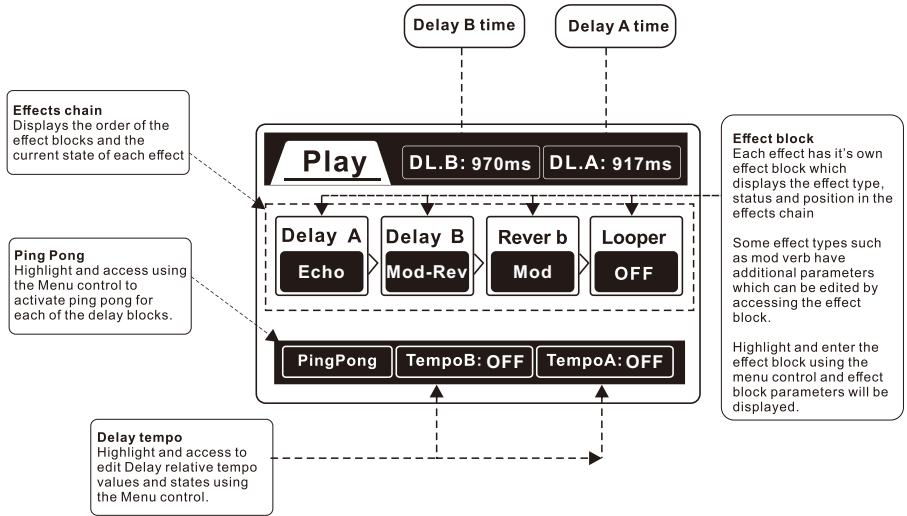

Navigation

- Rotate the **Menu** control to navigate the menu screen and adjust parameter values
- Press the **Menu** control to access parameter screens, enter parameters and set states
- Press the **Back** button to return to the menu screen
- Press the **Back** button whilst on the menu screen to resume normal operation (Menu control will now be a master mix control)

Edit effects signal chain

- Highlight the effect block you wish to move by rotating the Menu control knob.
- Press and hold the Menu control.
- Rotate the Menu control whilst holding it down, to move the effect block where you want it in the signal chain
- Release the Menu control to confirm effect block placement

Tempo sub division

- Highlight the Delay tempo you wish to edit at the bottom of the screen using the Menu control knob
- Press the Menu control to enter the Tempo sub-division screen
- Once in the sub-division screen press the Menu control to turn sub division on/off.
- Rotate the Menu control to adjust the sub division value. Press the Back button to return to the Menu Screen

Patch Mode

In patch mode the ocean machine recalls all effect settings from the stored presets and the controls work slightly differently.

Footswitch and control functions

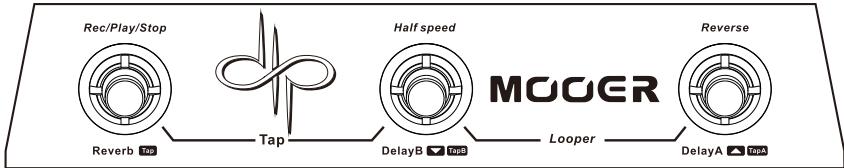

Reverb - Dedicated master Tap tempo. The footswitch LED will always show the current Tap tempo

DelayB - Previous preset

DelayA - Next Preset

Simultaneously depress the **Reverb + DelayB** footswitches to toggle between the preset selection screen and the Patch Control page

Simultaneously depress the **DelayB + DelayA** footswitches to enter/exit the looper

When on the Patch Control page all three footswitches and controls will maintain the same functions (except tap tempo) as in play mode, allowing you to engage or disengage the reverb or delays within your selected preset in real-time.

Effects Parameters

All of the basic effect parameters can be adjusted directly using their respective control knobs. More effect parameters, relative tempos, ping pong, effects chain, etc. can all be edited and adjusted within the Patch Control Page

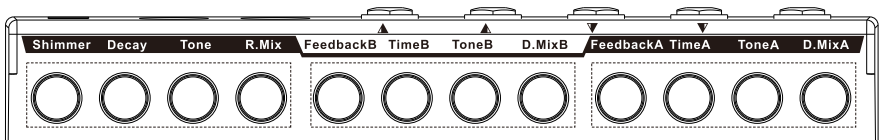

Rotating the Menu control will adjust the master mix

Pressing the Menu control will enter the Patch Control Page

Preset selection screen

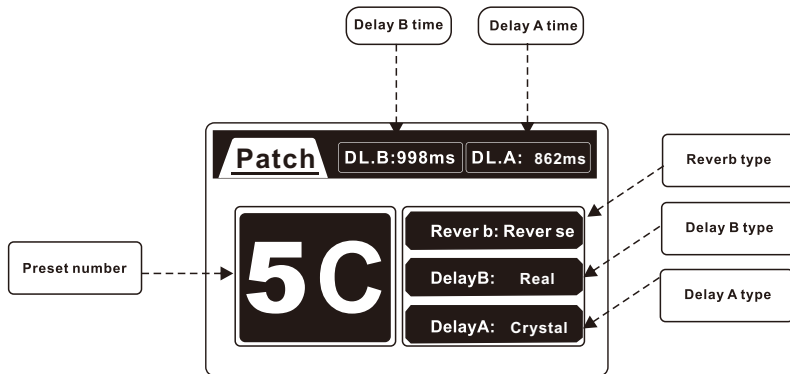

Press the menu button whilst in patch mode on the preset selection screen to enter the Patch Control page.

Alternatively you can simultaneously depress the **Reverb + DelayB** footswitches to toggle between the Patch Control page and the preset selection screen

Patch Control Page

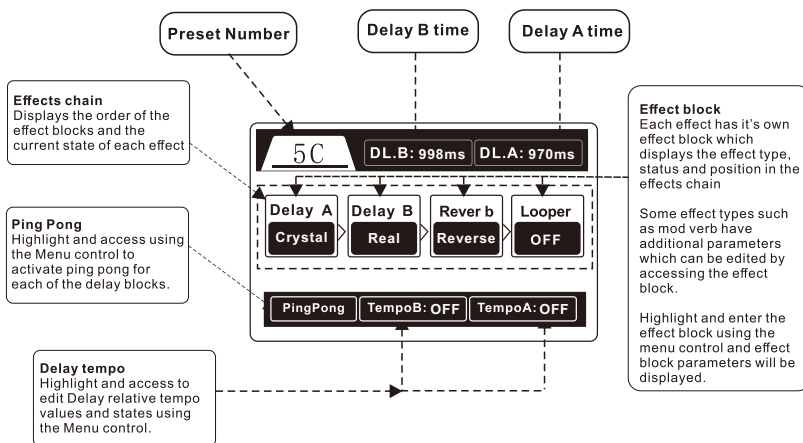

Navigation

- Rotate the Menu control to navigate the patch control page and adjust parameter values
- Press the Menu control to access parameter screens, enter parameters and set states
- Press the Back button to return to the patch control page
- Press Back whilst on the patch control page to resume normal operation (Menu control will now be a master mix control)

Effect Types

Reverb

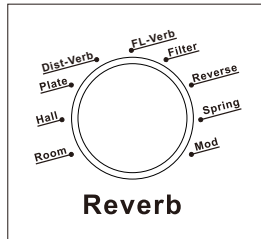

- Room:** Small room Reverb with a short decay
- Hall:** Large spacious Reverb with a long decay
- Plate:** Based on a traditional mechanical plate reverb
- Dist Verb:** Distorted Reverb
- FL-Verb:** Reverb with a modulated Flanger
- Filter:** Reverb with a modulated envelope follower
- Reverse:** Backwards Reverb
- Spring:** Based on a vintage, large tank, spring reverb
- Mod:** Reverb with a modulated Chorus

Delay B

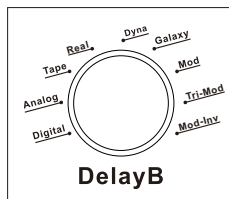

- Digital:** High fidelity delay with clean repeats
- Analog:** Vintage BB style delay with warm degrading repeats
- Tape:** Based on a classic reel to reel tape echo
- Real:** Clear delay with natural sounding repeats
- Dyna:** Dynamic Delay
- Galaxy:** Delay with swelled repeats and a light modulation
- Mod:** Delay with modulated repeats
- Tri mod:** 80's style delay with thick modulated repeats
- Mod-Inv:** Reverse delay with modulation

Delay A

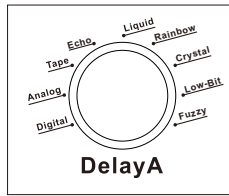

Digital:High fidelity delay with clean repeats

Analog:Vintage BB style delay with warm degrading repeats

Tape:Based on a classic reel to reel tape echo

Echo:Based on a vintage echorec

Liquid:Digital Delay with modulated Phaser repeats

Rainbow:Special effect pitch Delay with modulation

Crystal:Special effect pitch Delay with glistening highs

Low-Bit:Delay with bit crusher

Fuzzy:Delay with Fuzz

Note: All effects marked with a have extra parameters available for adjustment. Highlight the effect block and enter it's edit screen using the Menu control

Expression pedal

- An external expression pedal can be used to control various parameters of the ocean machine
- Connect an expression pedal to the EXP input of Ocean Machine using a TRS stereo jack cable
- You can select the parameters which the expression pedal controls on the Exp. page inside the Settings Menu

Looper

Ocean machine comes complete with a looper with up to 44 seconds of recording time, overdubbing, independent level control and full featured half speed + reverse effects.

To access the looper simultaneously depress the **DelayB** + **DelayA** footswitches.

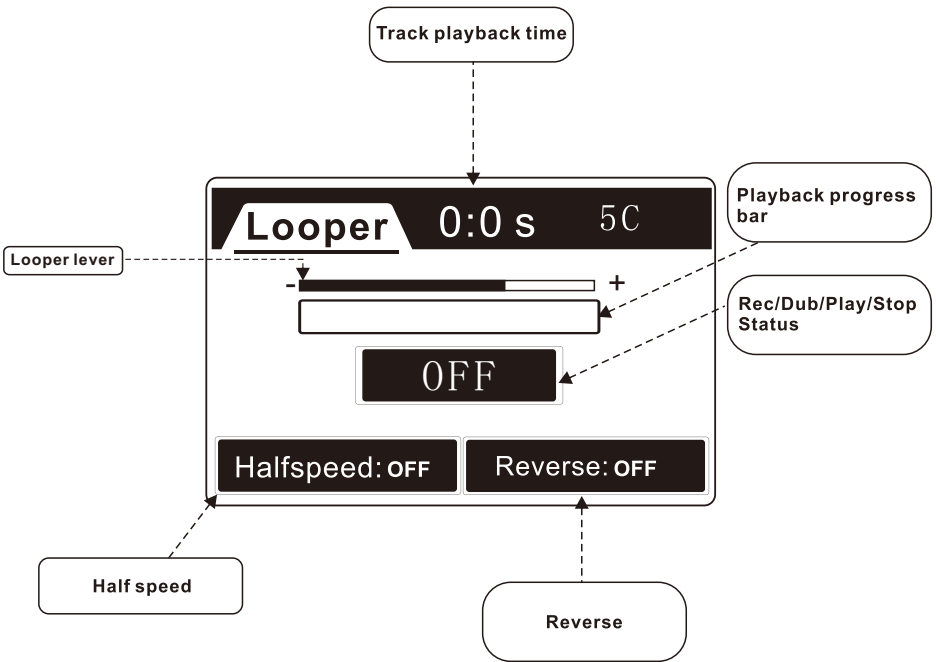

Footswitch and control functions

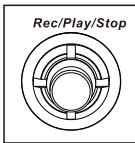
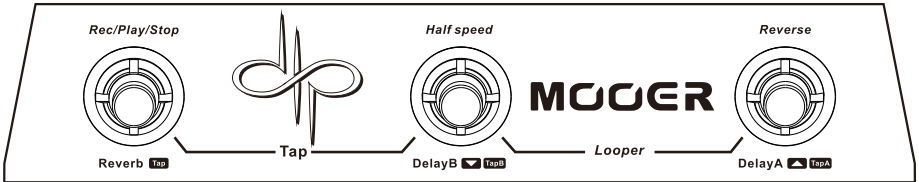

Record, Play, Dub, Double tap for stop, Hold for ClearAll

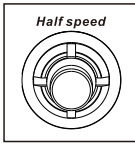

Half speed ON/OFF

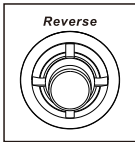

Reverse ON/OFF (this effect is available after recording the first loop)



When on the Looper screen, rotating the Menu control will adjust the playback level

* Note: You can go back and forth between the looper and your current operation screen while the looper is in operation by simultaneously pressing **DelayB** and **DelayA** footswitches

Settings Menu

Inside this menu you will find various global settings

Press the Setting button to enter the settings menu

Press the Back button to exit the settings menu

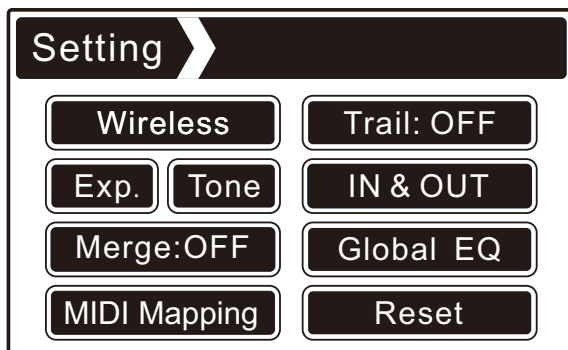

- Rotate the Menu control to navigate the settings menu
- Press the Menu button to access parameter screens, enter parameters and set states

Wireless

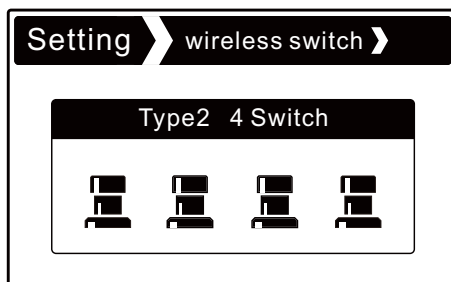
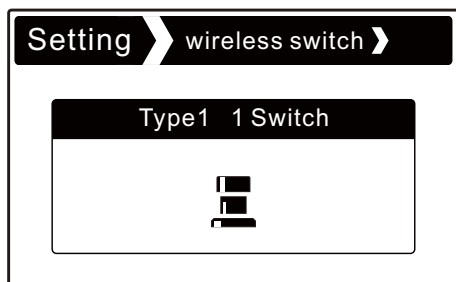

- Here we can select the wireless footswitch type when we have one connected to the Ocean Machine.
- Rotate the Menu knob to select the correct footswitch and press the Back button to confirm and return to the Settings menu

Exp.

In this page we can select which parameter is controlled by an external expression pedal and adjust the minimum threshold when the expression pedal is in heel down posit

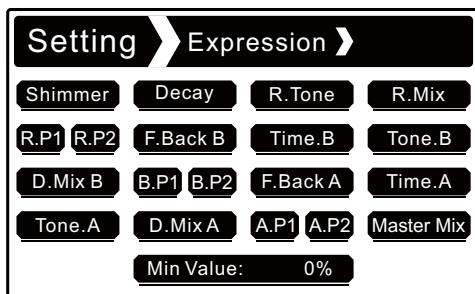

- Rotate the Menu control to select which parameter you want the expression pedal to control. This will be a global setting and can not be changed per preset
- Press the Menu control to confirm your selection

At the bottom of this page is a parameter named “Min Value”. Changing this percentage will adjust the minimum threshold when the expression pedal is in the heel down position

Tone

The tone controls on Ocean machine's delay and reverb effect blocks can independently be setup as high pass or as low pass filters

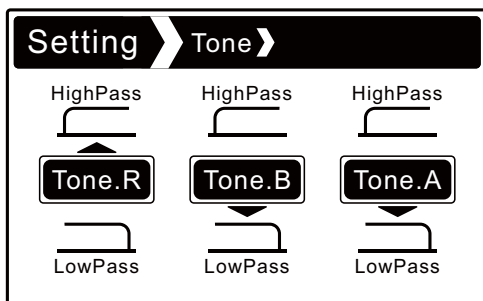

- Press the Menu control to select which tone control you wish to change
- Rotate the Menu control to select High pass or Low pass
- Press the Back button to return to the settings menu

Merge

With Merge activated, trails of the delays and reverbs will blend into each other when the effect type or preset is changed

- Press the Menu control to switch Merge on/off

Midi Mapping

Ocean Machine contains a full contents table of it's midi mapping so you don't need to carry a manual with it for programming midi control

MIDI CC#		MIDI PC#	
Function	CC#	Value	range
Reverb on/off	23	0	127
Reverb Type	3	0	8
Shimmer	46	0	127
Decay	47	0	127
Tone	48	0	127

MIDI CC#		MIDI PC#	
Preset	PC#		*
1A	#1		*
1B	#2		*
1C	#3		*
2A	#4		*
2B	#5		*

Ocean Machine operates on Midi Channel 1. It can receive midi signals but can not transmit them

- Press the Menu control to change between CC and PC tables
- Rotate the Menu control to scroll up and down these tables

Trail

With Trail activated the Ocean Machine operates in buffered bypass mode and the trails of delays and Reverbs will continue to finish after the effect is bypassed

With Trail deactivated the Ocean Machine operates in true bypass mode and the trails of delays and reverbs will terminate as soon as they are bypassed

- Press the Menu control to switch Trail on/off

IN & OUT

On this page we can adjust the global input and output levels

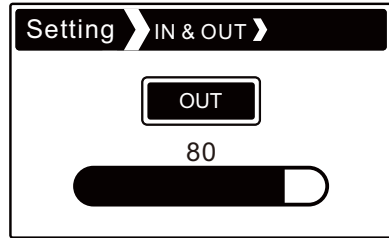
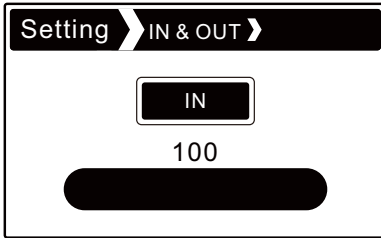

Press the Menu control to change between Input level and Output level

- Rotate the Menu control to adjust the level

Global EQ

Ocean Machine is equipped with a Global EQ section which will affect both your dry guitar signal and the sound of the effects. This can be switched on or off

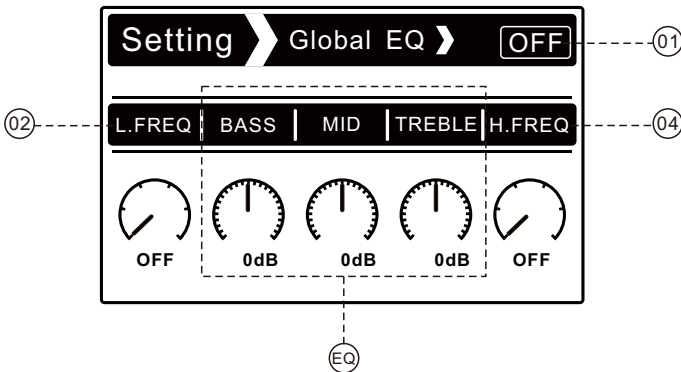

1.ON/OFF

Switches the Global EQ on or off

2.L.FREQ

Adjustable low frequency cut

3.EQ

Cut or boost BASS, MID, and TREBLE frequencies up to +-12dB

12 O'clock is 0dB boost or cut

4.H.FREQ

Adjustable high frequency cut

- Press the Menu control to select the parameter you wish to adjust
- Rotate the Menu control to adjust the parameters value

Reset

This will perform a factory reset of your ocean machine

- Rotate the Menu control to select YES
- Press the Menu control to confirm factory reset

Select NO or press the Back button to cancel the factory reset procedure

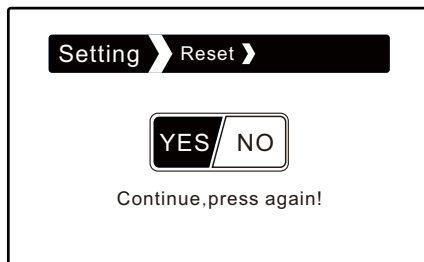
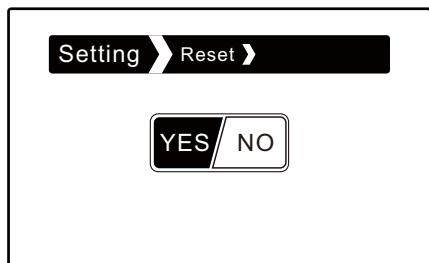

Storing Presets

- After creating a sound in Play mode or the Patch Control Page you wish to save, press the **Save** button.
- The screen will display a preset number
- Rotate the **Menu** control till you find the preset space where you want to save your sound
- Press the **Save** button one more time to confirm or press **Back** to exit the saving procedure

Wireless Footswitch

For a more complete experience you can purchase one of our wireless footswitch controllers to expand your Ocean Machine controls.

- Power off the Ocean Machine
- Press and hold the footswitch on the wireless controller (single FS type)
Press and hold C+D footswitches on the wireless controller (4 FS type)
- Connect power to the Ocean Machine
- Wait for the Ocean Machine to fully finish booting up before releasing the wireless controllers footswitch
- Navigate to: "Setting > Wireless" and set the parameter to the correct controller type

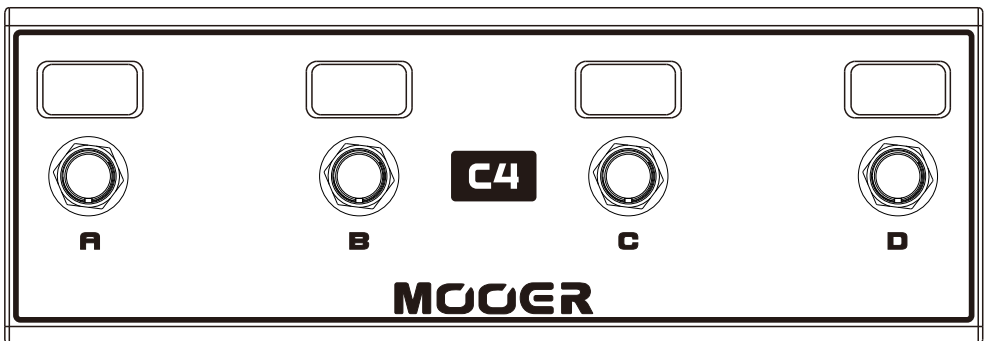

MIDI

Ocean Machine operates on Midi Channel 1. It can receive midi signals but can not transmit them

Programme Change signals (PC) are used to recall presets

Control Change signals (CC) are used to switch effects on/off and control parameter values

Function	CC#	Value Range
Reverb On/Off	23	0-127 (On:>=64;Off:<64)
Reverb type	3	0-8
Shimmer	46	0-127
Decay	47	0-127
Tone	48	0-127
R.Mix	49	0-127
R.P1	50	0-127
R.P2	51	0-127
Delay B On/Off	25	0-127 (On:>=64;Off:<64)
Delay type B	9	0-8
Feedback B	59	0-127
Time B	60	0-127
D.Tone B	61	0-127
D.Mix B	62	0-127
B.P1	63	0-127
B.P2	64	0-127
Pingpong B	65	0-127(On:>=64;Off:<64)
TempoB	20	0-14
Delay A On/Off	24	0-127 (On:>=64;Off:<64)
Delay type A	12	0-8
Feedback A	52	0-127
Time A	53	0-127
D.Tone A	54	0-127
D.Mix A	55	0-127
A.P1	56	0-127
A.P2	57	0-127
Pingpong A	58	0-127(On:>=64;Off:<64)
TempoA	21	0-14

Function	CC#	Value Range
Looper In&Out	26	0-127(In:>=64;Out:<64)
Rec/Dub	27	0-127
Play	28	0-127
Stop	29	0-127
Clear All	30	0-127
HalfSpeed	31	0-127(On:>=64;Off:<64)
Reverse	32	0-127(On:>=64;Off:<64)
Loop-Level	45	0-60
wireless	33	0-1
Expression pedal	34	0-18
Expression Min Value	35	0-100
Trail On/Off	70	0-127(On:>=64;Off:<64)
EQ On/Off	36	0-127(On:>=64;Off:<64)
L.FREQ	37	0-5
BASS	38	0-24
MID	39	0-24
TREBLE	40	0-24
H.FREQ	41	0-5
Input Level	42	0-100
Output Level	43	0-100
Master Mix	44	0-100
R.Tone	66	0-1
B.Tone	67	0-1
A.Tone	68	0-1
Merge	69	0-127(On:>=64;Off:<64)

Preset	Midi program NO.
1A	Midi program #1
1B	Midi program #2
1C	Midi program #3
2A	Midi program #4
2B	Midi program #5
2C	Midi program #6
3A	Midi program #7
3B	Midi program #8
3C	Midi program #9
4A	Midi program #10
4B	Midi program #11
4C	Midi program #12

Preset	Midi program NO.
5A	Midi program #13
5B	Midi program #14
5C	Midi program #15
6A	Midi program #16
6B	Midi program #17
6C	Midi program #18
7A	Midi program #19
7B	Midi program #20
7C	Midi program #21
8A	Midi program #22
8B	Midi program #23
8C	Midi program #24

Firmware Update

From time to time MOOER will release new firmware updates for Ocean Machine which will include new features or any bug fixes subsequent to user feedback.

You will require a USB > MIDI interface cable to complete the firmware update

1. Download "OM_IAP.zip" from www.moeraudio.com
2. Extract "OM_IAP.exe" and "OM_PROGRAM_FILE.bin"
3. Connect your midi interface to the computers USB.
Connect the MIDI OUT cable to Ocean Machine's MIDI IN socket
Connect the MIDI IN cable to Ocean Machine's MIDI THRU socket
4. Press and hold the "BACK" and "SETTING" buttons on the Ocean Machine. Connect power to the Ocean Machine and do not release the buttons until the screen displays a "Loading" message
5. Open the "OM_IAP.exe" file to start the update software program
Click "OpenFile" inside the software update program, navigate to the "OM_PROGRAM_FILE.Bin" and open it
6. Click the "Update" button in the OM_IAP software to download the new firmware file to the Ocean Machine
7. When the update is complete the OM_IAP software will display a message "Update successful" and the Ocean Machine will exit the loading page and revert back to regular operation

Note: If the update procedure fails then please start again and repeat the steps in this guide

To avoid any errors please do not connect to multiple MIDI devices while updating the ocean machine

MOOER

MOOER AUDIO CO.,LTD
Shenzhen, China
www.mooeraudio.com