

# 828es™

## User Guide



# MOTU®

---

1280 Massachusetts Avenue  
Cambridge, MA 02138  
Business voice: (617) 576-2760  
Business fax: (617) 576-3609  
Web site: [www.motu.com](http://www.motu.com)  
Tech support: [www.motu.com/support](http://www.motu.com/support)

## SAFETY PRECAUTIONS AND ELECTRICAL REQUIREMENTS FOR THE 828es ("PRODUCT")

 **CAUTION! READ THIS SAFETY GUIDE BEFORE YOU BEGIN INSTALLATION OR OPERATION. FAILURE TO COMPLY WITH SAFETY INSTRUCTIONS COULD RESULT IN BODILY INJURY OR EQUIPMENT DAMAGE.**

 **HAZARDOUS VOLAGES: CONTACT MAY CAUSE ELECTRIC SHOCK OR BURN. TURN OFF UNIT BEFORE SERVICING.**

**WARNING: TO REDUCE THE RISK OF FIRE OR ELECTRICAL SHOCK, DO NOT EXPOSE THIS APPLIANCE TO RAIN OR OTHER MOISTURE.**

**CAUTION: TO REDUCE THE RISK OF ELECTRICAL SHOCK, DO NOT REMOVE COVER. NO USER-SERVICEABLE PARTS INSIDE. REFER SERVICING TO QUALIFIED SERVICE PERSONNEL.**

**WARNING: DO NOT PERMIT FINGERS TO TOUCH THE TERMINALS OF PLUGS WHEN INSTALLING OR REMOVING THE PLUG TO OR FROM THE OUTLET.**

**WARNING: IF NOT PROPERLY GROUNDED THE MOTU PRODUCT COULD CAUSE AN ELECTRICAL SHOCK.**

The MOTU product is equipped with a three-conductor cord and grounding type plug which has a grounding prong, approved by Underwriters' Laboratories and the Canadian Standards Association. This plug requires a mating three-conductor grounded type outlet as shown in Figure A below. If the outlet you are planning to use for the MOTU product is of the two prong type, DO NOT REMOVE OR ALTER THE GROUNDING PRONG IN ANY MANNER. Use an adapter as shown below and always connect the grounding lug to a known ground. It is recommended that you have a qualified electrician replace the TWO prong outlet with a properly grounded THREE prong outlet. An adapter as illustrated below in Figure B is available for connecting plugs to two-prong receptacles.

Figure A

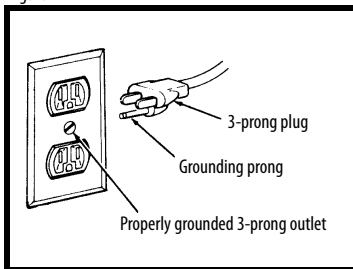
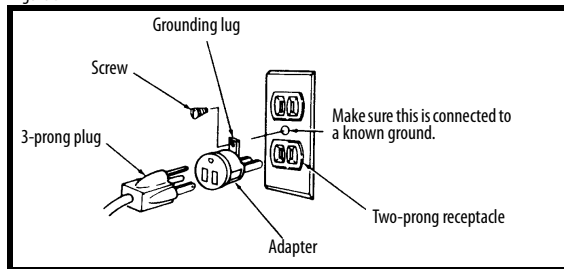

Figure B



**WARNING: THE GREEN GROUNDING LUG EXTENDING FROM THE ADAPTER MUST BE CONNECTED TO A PERMANENT GROUND SUCH AS TO A PROPERLY GROUNDED OUTLET BOX. NOT ALL OUTLET BOXES ARE PROPERLY GROUNDED.**

If you are not sure that your outlet box is properly grounded, have it checked by a qualified electrician. NOTE: The adapter illustrated is for use only if you already have a properly grounded two-prong receptacle. Adapter is not allowed in Canada by the Canadian Electrical Code. Use only three wire extension cords which have three-prong grounding type plugs and three-prong receptacles which will accept the MOTU product plug.

### IMPORTANT SAFEGUARDS

1. Read these instructions. All the safety and operating instructions should be read before operating the product.
2. Keep these instructions. These safety instructions and the product owner's manual should be retained for future reference.
3. Heed all warnings. All warnings on the product and in the owner's manual should be adhered to.
4. Follow all instructions. All operating and use instructions should be followed.
5. Do not use the product near water.
6. Cleaning - Unplug the product from the computer and clean only with a dry cloth. Do not use liquid or aerosol cleaners.
7. Ventilation - Do not block any ventilation openings. Install in accordance with the manufacturer's instructions.
8. Heat - Do not install the product near any heat sources such as radiators, heat registers, stoves, or another apparatus (including an amplifier) that produces heat.
9. Overloading - Do not overload wall outlets and extension cords as this can result in a risk of fire or electrical shock.
10. Grounding - Do not defeat the safety purpose of the polarized or grounding-type plug. A polarized plug has two blades with one wider than the other. A grounding-type plug has two blades and a third grounding prong. The wide blade or the third prong are provided for your safety. If the provided plug does not fit into your outlet, consult an electrician for replacement of the obsolete outlet.
11. Power cord - Protect the product power cord from being walked on or pinched by items placed upon or against them. Pay particular attention to cords and plugs, convenience receptacles, and the point where they exit from the unit.
12. Power switch - Install the product so that the power switch can be accessed and operated at all times.
13. Disconnect - The main plug is considered to be the disconnect device for the product and shall remain readily operable.
14. Accessories - Only use attachments/accessories specified by the manufacturer.
15. Placement - Use only with the cart, stand, tripod, bracket or table specified by the manufacturer, or sold with the product. When a cart is used, use caution when moving the cart/apparatus combination to avoid injury from tip-over.
16. Surge protection - Unplug the product during lightning storms or when unused for long periods of time.
17. Servicing - Refer all servicing to qualified service personnel. Servicing is required when the product has been damaged in any way, such as when a power-supply cord or plug is damaged, liquid has been spilled or objects have fallen into the product, the product has been exposed to rain or moisture, does not operate normally, or has been dropped.
18. Power Sources - Refer to the manufacturer's operating instructions for power requirements. Be advised that different operating voltages may require the use of a different line cord and/or attachment plug.
19. Installation - Do not install the product in an unventilated rack, or directly above heat-producing equipment such as power amplifiers. Observe the maximum ambient operating temperature listed below.
20. Power amplifiers - Never attach audio power amplifier outputs directly to any of the unit's connectors.
21. Replacement Parts - When replacement parts are required, be sure the service technician has used replacement parts specified by the manufacturer or have the same characteristics as the original part. Unauthorized substitutions may result in fire, electric shock or other hazards.
22. Safety Check - Upon completion of any service or repairs to this MOTU product, ask the service technician to perform safety checks to determine that the product is in safe operating conditions.

### ENVIRONMENT, HEAT AND VENTILATION

Operating Temperature: 10°C to 40°C (50°F to 104°F). The product should be situated away from heat sources or other equipment that produces heat. When installing the product in a rack or any other location, be sure there is adequate space around the product to ensure proper ventilation. Improper ventilation will cause overheating and can damage the unit.

### TO REDUCE THE RISK OF ELECTRICAL SHOCK OR FIRE

Do not handle the power cord with wet hands. Do not pull on the power cord when disconnecting it from an AC wall outlet. Grasp it by the plug. Do not expose this apparatus to rain or moisture. Do not place objects containing liquids on it.

### AC INPUT

100 - 240VAC ~ - 50 / 60Hz • 0.5A max



# Contents

## *Part 1: Getting Started*

---

- 7 **Quick Start Guide**
- 9 **828es Front Panel**
- 10 **828es Rear Panel**
- 11 **MOTU Pro Audio Control Web App**
- 23 **About the 828es**
- 27 **Packing List and System Requirements**
- 29 **Software Installation**
- 33 **Hardware Installation**

## *Part 2: Using the 828es*

---

- 53 **Presets**
- 57 **Front Panel Operation**
- 63 **Working with Host Audio Software**
- 71 **Mixer Effects**
- 79 **MOTU Audio Tools**
- 95 **Networking**

## *Part 3: Appendices*

---

- 103 **Troubleshooting**
- 105 **Audio Specifications**
- 109 **Mixer Schematics**
- 113 **Updating Firmware**
- 115 **OSC Support**
- 117 **Index**

## About the Mark of the Unicorn License Agreement and Limited Warranty on Software

TO PERSONS WHO PURCHASE OR USE THIS PRODUCT: carefully read all the terms and conditions of the "click-wrap" license agreement presented to you when you install the software. Using the software or this documentation indicates your acceptance of the terms and conditions of that license agreement.

Mark of the Unicorn, Inc. ("MOTU") owns both this program and its documentation. Both the program and the documentation are protected under applicable copyright, trademark, and trade-secret laws. Your right to use the program and the documentation are limited to the terms and conditions described in the license agreement.

### REMINDER OF THE TERMS OF YOUR LICENSE

This summary is not your license agreement, just a reminder of its terms. The actual license can be read and printed by running the installation program for the software. That license agreement is a contract, and clicking "Accept" binds you and MOTU to all its terms and conditions. In the event anything contained in this summary is incomplete or in conflict with the actual click-wrap license agreement, the terms of the click-wrap agreement prevail.

YOU MAY: (a) use the enclosed program on a single computer; (b) physically transfer the program from one computer to another provided that the program is used on only one computer at a time and that you remove any copies of the program from the computer from which the program is being transferred; (c) make copies of the program solely for backup purposes. You must reproduce and include the copyright notice on a label on any backup copy.

YOU MAY NOT: (a) distribute copies of the program or the documentation to others; (b) rent, lease or grant sublicenses or other rights to the program; (c) provide use of the program in a computer service business, network, time-sharing, multiple CPU or multiple user arrangement without the prior written consent of MOTU; (d) translate, adapt, reverse engineer, decompile, disassemble, or otherwise alter the program or related documentation without the prior written consent of MOTU.

MOTU warrants to the original licensee that the disk(s) on which the program is recorded be free from defects in materials and workmanship under normal use for a period of ninety (90) days from the date of purchase as evidenced by a copy of your receipt. If failure of the disk has resulted from accident, abuse or misapplication of the product, then MOTU shall have no responsibility to replace the disk(s) under this Limited Warranty.

THIS LIMITED WARRANTY AND RIGHT OF REPLACEMENT IS IN LIEU OF, AND YOU HEREBY WAIVE, ANY AND ALL OTHER WARRANTIES, BOTH EXPRESS AND IMPLIED, INCLUDING BUT NOT LIMITED TO WARRANTIES OF MERCHANTABILITY AND FITNESS FOR A PARTICULAR PURPOSE. THE LIABILITY OF MOTU PURSUANT TO THIS LIMITED WARRANTY SHALL BE LIMITED TO THE REPLACEMENT OF THE DEFECTIVE DISK(S), AND IN NO EVENT SHALL MOTU OR ITS SUPPLIERS, LICENSORS, OR AFFILIATES BE LIABLE FOR INCIDENTAL OR CONSEQUENTIAL DAMAGES, INCLUDING BUT NOT LIMITED TO LOSS OF USE, LOSS OF PROFITS, LOSS OF DATA OR DATA BEING RENDERED INACCURATE, OR LOSSES SUSTAINED BY THIRD PARTIES EVEN IF MOTU HAS BEEN ADVISED OF THE POSSIBILITY OF SUCH DAMAGES. THIS WARRANTY GIVES YOU SPECIFIC LEGAL RIGHTS WHICH MAY VARY FROM STATE TO STATE. SOME STATES DO NOT ALLOW THE LIMITATION OR EXCLUSION OF LIABILITY FOR CONSEQUENTIAL DAMAGES, SO THE ABOVE LIMITATION MAY NOT APPLY TO YOU.

### UPDATE POLICY

In order to be eligible to obtain updates of the program, you must complete and return the attached Mark of the Unicorn Purchaser Registration Card to MOTU.

### COPYRIGHT NOTICE

Copyright © 2017 by Mark of the Unicorn, Inc. All rights reserved. No part of this publication may be reproduced, transmitted, transcribed, stored in a retrieval system, or translated into any human or computer language, in any form or by any means whatsoever, without express written permission of Mark of the Unicorn, Inc., 1280 Massachusetts Avenue, Cambridge, MA, 02138, U.S.A.

### LIMITED WARRANTY ON HARDWARE

Mark of the Unicorn, Inc. and S&S Research ("MOTU/S&S") warrant this equipment against defects in materials and workmanship for a period of TWO (2) YEARS from the date of original retail purchase. This warranty applies only to hardware products; MOTU software is licensed and warranted pursuant to separate written statements.

If you discover a defect, first write or call Mark of the Unicorn at (617) 576-2760 to obtain a Return Merchandise Authorization Number. No service will be performed on any product returned without prior authorization. MOTU will, at its option, repair or replace the product at no charge to you, provided you return it during the warranty period, with transportation charges prepaid, to Mark of the Unicorn, Inc., 1280 Massachusetts Avenue, MA 02138. You must use the product's original packing material for in shipment, and insure the shipment for the value of the product. Please include your name, address, telephone number, a description of the problem, and the original, dated bill of sale with the returned unit and print the Return Merchandise Authorization Number on the outside of the box below the shipping address.

This warranty does not apply if the equipment has been damaged by accident, abuse, misuse, or misapplication; has been modified without the written permission of MOTU, or if the product serial number has been removed or defaced.

ALL IMPLIED WARRANTIES, INCLUDING IMPLIED WARRANTIES OF MERCHANTABILITY AND FITNESS FOR A PARTICULAR PURPOSE, ARE LIMITED IN DURATION TO TWO (2) YEARS FROM THE DATE OF THE ORIGINAL RETAIL PURCHASE OF THIS PRODUCT.

THE WARRANTY AND REMEDIES SET FORTH ABOVE ARE EXCLUSIVE AND IN LIEU OF ALL OTHERS, ORAL OR WRITTEN, EXPRESS OR IMPLIED. No MOTU/S&S dealer, agent, or employee is authorized to make any modification, extension, or addition to this warranty.

MOTU/S&S ARE NOT RESPONSIBLE FOR SPECIAL, INCIDENTAL, OR CONSEQUENTIAL DAMAGES RESULTING FROM ANY BREACH OF WARRANTY, OR UNDER ANY LEGAL THEORY, INCLUDING LOST PROFITS, DOWNTIME, GOODWILL, DAMAGE OR REPLACEMENT OF EQUIPMENT AND PROPERTY AND COST OF RECOVERING REPROGRAMMING, OR REPRODUCING ANY PROGRAM OR DATA STORED IN OR USED WITH MOTU/S&S PRODUCTS.

Some states do not allow the exclusion or limitation of implied warranties or liability for incidental or consequential damages, so the above limitation or exclusion may not apply to you. This warranty gives you specific legal rights, and you may have other rights which vary from state to state.

MOTU, Digital Performer, AudioDesk, Mark of the Unicorn and the unicorn silhouette logo are trademarks of Mark of the Unicorn, Inc.

Thunderbolt and the Thunderbolt logo are trademarks of Intel Corporation in the U.S. and/or other countries.

This equipment has been type tested and found to comply with the limits for a class B digital device, pursuant to Part 15 of the FCC Rules. These limits are designed to provide reasonable protection against harmful interference in a residential installation. This equipment generates, uses, and can radiate radio frequency energy and, if not installed and used in accordance with the instruction manual, may cause harmful interference to radio communications. However, there is no guarantee that interference will not occur in a particular installation. If this equipment does cause interference to radio or television equipment reception, which can be determined by turning the equipment off and on, the user is encouraged to try to correct the interference by any combination of the following measures:

- Relocate or reorient the receiving antenna
- Increase the separation between the equipment and the receiver
- Plug the equipment into an outlet on a circuit different from that to which the receiver is connected

If necessary, you can consult a dealer or experienced radio/television technician for additional assistance.

PLEASE NOTE: only equipment certified to comply with Class B (computer input/output devices, terminals, printers, etc.) should be attached to this equipment, and it must have shielded interface cables in order to comply with the Class B FCC limits on RF emissions.

WARNING: changes or modifications to this unit not expressly approved by the party responsible for compliance could void the user's authority to operate the equipment.





*Part 1*

*Getting Started*



# Quick Start Guide

Thank you for purchasing an 828es! Follow these easy steps to get started quickly.

**1** Download and run the *MOTU Pro Audio Installer* found here:

<http://www.motu.com/proaudio>

**2** (Optional) For quick access to the 828es from your iPad or iPhone, download the MOTU Discovery app from the Apple App Store.

👉 Your iPhone and iPad must be on the same Wi-Fi network as your computer.

**3** Connect the interface to your computer with a USB cable (included) or Thunderbolt cable (sold separately). If you have a Thunderbolt-equipped Mac running OS X El Capitan (10.11) or later, you can alternately connect the 828es to the Mac's Ethernet port with a standard CAT-5e or CAT-6 Ethernet cable (sold separately).

**4** Switch on the 828es.

**5** Open the *MOTU Pro Audio Control* web app by doing one of the following:

- Choose the 828es from the MOTU Discovery app menu (found in the Mac menu bar or Windows taskbar).
- Alternately, you can launch the *MOTU Pro Audio WebUI Setup* shortcut found on the Windows desktop or in *Start menu > All Programs > MOTU*.
- From your iPad or iPhone, launch the MOTU Discovery app, and tap your interface.

- You should now see the *MOTU Pro Audio Control* web app in your browser, as shown on page 12. If not, visit Appendix A, “Troubleshooting” page (103).
- For advanced network options, and device discovery from any modern browser, see chapter 11, “Networking” (page 95).

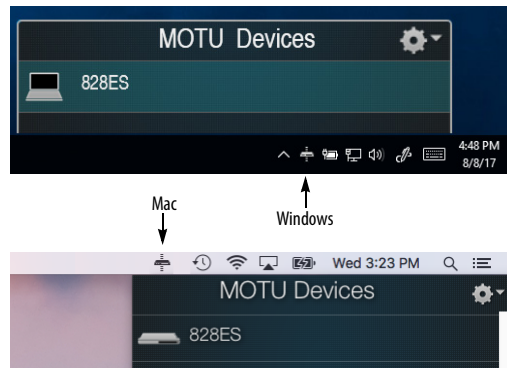

**6** Choose a preset from the Quick Setup.

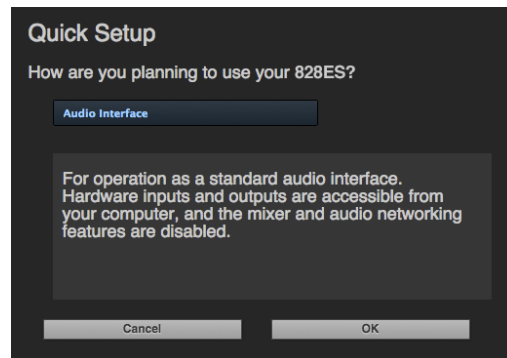

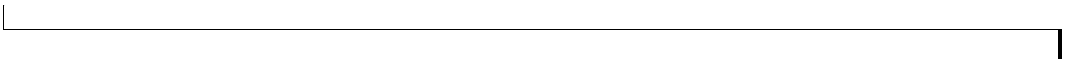

# 828es Front Panel

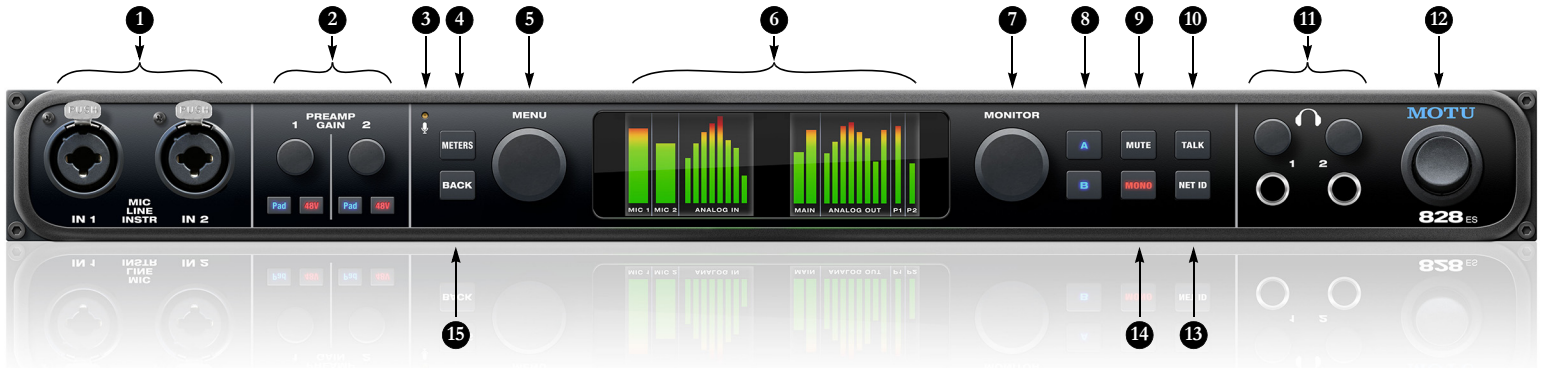

1. These XLR/TRS combo jacks accept a mic cable or a quarter-inch cable, balanced or unbalanced, from a guitar or line input. Use the front panel controls to adjust individual preamp gain, 48V phantom power and optional -20 dB pad for each mic input.
2. Individual MIC INPUT preamp gain, switchable 48V phantom power, and optional -20 dB pad switches for each mic input. The Precision Digital Trim™ knob provides 63 dB of preamp gain. Turn the knob to see the gain adjustments in the LCD. Push in the knob to lock the gain adjustment on screen; press it again to unlock and dismiss.
3. This is the built-in talkback mic, so that you can use the talkback feature (10) without using up one of the two mic inputs. See “Talkback” on page 60.
4. Press the METERS button to cycle among several LCD screen sets, which display meters for the analog inputs and outputs, metering for all digital I/O, device settings and the menu.
5. Push the MENU knob to enter the LCD menu. Turn it to scroll through menu options. Push again to go into the sub-menus, if applicable. To choose the current setting, push MENU a third time. Use the BACK button to return to the previous menu level. Push METERS to return directly to the main screen.
6. The 828es dual color LCDs display metering, device settings and menu navigation. Press METERS (4) to cycle among several screen sets or return home after menu navigation. Use the MENU knob and BACK button for menu navigation.
7. The MONITOR knob controls the volume of both the A and B monitor output pairs, regardless of which one is currently selected. To change the relative volume between the A and B monitor outs, see “Monitor volume control” on page 60.
8. Use the A/B monitor select buttons to switch your studio’s primary stereo output between two pairs of studio monitors connected to the 828es XLR main outs and TRS line outs 1–2, respectively. You can reassign these output pairs as desired. See “Output assignments for Monitor A and B” on page 59. To enable both pairs simultaneously, push both buttons simultaneously.
9. Push MUTE to silence the A/B monitor outputs.
10. Push TALK to speak to musicians located in a separate studio room or isolation booth via the 828es built-in talkback mic (3). See “Talkback” on page 60.
11. Two independent HEADPHONE OUTPUTS with volume control. As you turn the knob, the LCD provides visual feedback with a volume meter.
12. POWER SWITCH: Thunderbolt, AVB, and USB are “plug-and-play” protocols. That means you can switch off the 828es and turn it back on without restarting your computer.
13. Push NET ID to display network settings for the device, including its IP address.
14. Push MONO to sum each A/B monitor stereo pair to mono. Push it again to return to stereo operation.
15. Push BACK to go back one level when navigating the LCD menu.

# 828es Rear Panel



- The 828es is equipped with an auto-switching international power supply.
- These are standard BNC word clock jacks. Use them for a variety of applications, such as digital transfers with devices that cannot resolve to the clock supplied by their digital I/O connection with the 828es.
- These two banks of ADAT optical “lightpipe” connectors each provide 8 channels of 24-bit ADAT optical digital I/O at 1x sample rates (44.1 or 48 kHz) and 4 channels at 2x sample rates (88.2 or 96 kHz). They are disabled at higher sample rates. Alternately, they can operate as stereo TosLink (optical S/PDIF) connectors.  
  
Note: you can choose independent formats for each bank, A and B, as well as IN and OUT within each bank. For example, you could choose ADAT for the optical A IN (for, say, eight channels of input from your digital mixer) and stereo TosLink for the optical A OUT (for, say, your DAT machine).
- These jacks provide stereo, 24-bit S/PDIF digital input and output at all supported sample rates (up to 96 kHz). When connecting a source to the input, be sure to set the clock source correctly. See “Syncing S/PDIF devices” on page 47.
- Connect a MIDI device here using standard MIDI cables. Connect the 828es MIDI OUT port to the MIDI IN port on the other device. Conversely, connect the 828es MIDI IN port to the MIDI OUT port on the other device. You can connect different devices to each port, such as a controller device to the IN port and a sound module to the OUT port. You can also daisy-chain MIDI devices, but be sure to manage their MIDI channels (so that they don’t receive or transmit on the same channel).
- Connect a standard foot switch here for hands-free punch-in and punch-out during recording. For details about how to set this up, see item #34 in the Device tab overview (page 14).
- These eight analog inputs are balanced (TRS) quarter-inch connectors that can also accept an unbalanced plug. Use with line level signals up to +24 dBu, including synthesizers, drum machines, effects processors, etc. These inputs are also equipped with the 828es Precision Digital Trim™ feature: digitally controlled analog trims that let you adjust input level in 1 dB increments from the included MOTU Pro Audio Control web app software.
- The eight analog outputs are balanced, DC-coupled quarter-inch connectors that can also accept an unbalanced plug. They provide additional analog output for secondary studio monitors, surround monitoring, sub-mixes or any other desired destination. The output trim can be adjusted from the Device Tab in the MOTU Pro Audio Control web app software. From the factory, outputs 1-2 serve as monitor pair B for front panel A/B monitor switching. (The XLR main outs serve as pair A.)
- These are quarter-inch analog SMPTE input and output jacks. Use them to resolve the 828es directly to time code and transmit time code to other devices.
- These two XLR jacks serve as the 828es main output pair for primary (powered) studio monitors, PA speakers or any other desired destination. You can control their volume from the front panel MONITOR knob. They also serve as monitor pair A for the 828es front panel A/B monitor switching feature.  
  
To hear audio playback from your host audio software on the MAIN OUT pair, use the Audio Interface preset and then assign audio tracks (and master fader) to these main outs. You can also use the MOTU Pro Audio Control web app to route live 828es inputs (and network inputs) here as well.
- These two balanced quarter-inch sends supply the pre-amplified input signal from the mic/line/instrument inputs on the front panel. Use them to insert your favorite compressor, EQ, reverb or other outboard effect. Use any analog input as a return.
- Connect the 828es to the computer here via either Thunderbolt or USB, using a standard Thunderbolt or USB cable (one or the other, but not both). For details, see chapter 5, “Hardware Installation” (page 33).
- This AVB/TSN Ethernet port provides industry standard IEEE 802.1 network connectivity to other network devices. Examples include:
  - Another 828es or any other MOTU AVB-equipped audio interface, such as the 1248, 8M, 16A, 24Ai, 24Ao, 112D, Monitor 8, etc.
  - A standard Ethernet hub or Wi-Fi router (for internet connection and communication with the web app software).
  - A standard AVB Ethernet switch for high-speed, low-latency, high-capacity audio connectivity to an AVB audio network.
  - A recent-generation Mac (any Mac with a Thunderbolt port) running OS X El Capitan (10.11) or later. This allows you to operate the 828es as an audio interface over Ethernet.

# CHAPTER 1 MOTU Pro Audio Control Web App

## OVERVIEW

*MOTU Pro Audio Control* is a web app that gives you complete control over the 828es. If you have several MOTU interfaces networked together, such as the 828es, 1248 and 8M, you can control them all. If you are working with a large network of many MOTU interfaces, you can access any device on the network.

## IT'S NOT ON YOUR HARD DRIVE

The MOTU Pro Audio Control web app is served from the 828es hardware itself, therefore it is not an application on your computer's hard drive. Instead, access it from the *MOTU Discovery* app (in the Mac menu bar or Windows taskbar), the *MOTU Pro Audio WebUI Setup* shortcut (Windows only) or through your web browser.

## USE YOUR FAVORITE WEB BROWSER

The MOTU Pro Audio Control web app runs in any modern web browser on any device connected to the 828es, either directly or wirelessly through a Wi-Fi network. You can use any device you wish: a desktop computer, laptop, iPad, tablet, iPhone or smart phone. If it can run a web browser, it can run the web app. You can use any browser you prefer: Chrome, Firefox, Safari, etc. The latest versions are strongly recommended.

## CONTROL FROM MULTIPLE DEVICES

You can run the web app on multiple host devices simultaneously.

## RUN THE INSTALLER, GET THE APP

Visit [www.motu.com/download](http://www.motu.com/download) to get the latest MOTU Pro Audio Installer and run it on your computer to install the *MOTU Discovery* app, *MOTU Pro Audio WebUI Setup* shortcut

(Windows only) and other software elements. Visit the Apple App Store to install the discovery app on your iPad or iPhone.

## MAKE HARDWARE AND NETWORK CONNECTIONS

Connect your 828es to your computer or laptop with a USB or Thunderbolt cable. Make sure your iPad, iPhone, tablet or smartphone is connected to the same Wi-Fi network as your computer or device, as explained in "Setup for web app control" on page 38.

## LAUNCHING THE WEB APP

To launch the web app, do any of the following:

- Choose the 828es from the MOTU Discovery app menu (in the Mac menu bar or Windows taskbar, as shown on page 7) or launch the *MOTU Pro Audio WebUI Setup* shortcut (Windows only).
- From your iPad or iPhone, launch the MOTU Discovery app.
- In your favorite web browser, type this URL: *localhost:1280*. (This URL requires a Thunderbolt or USB connection to the 828es.)
- If the 828es Ethernet port is connected to your Ethernet or Wi-Fi network, type the unit's IP address (see below) into your browser.

You should now see the MOTU Pro Audio Control web app in your browser, as shown on page 12. If not, visit Appendix A, "Troubleshooting" page (103).

## Obtaining the 828es IP address

On the front panel of the interface, push the NET ID button. The LCD now displays the unit's IP address, which should look something like this: "IP: 192.168.1.209".

## DEVICE TAB

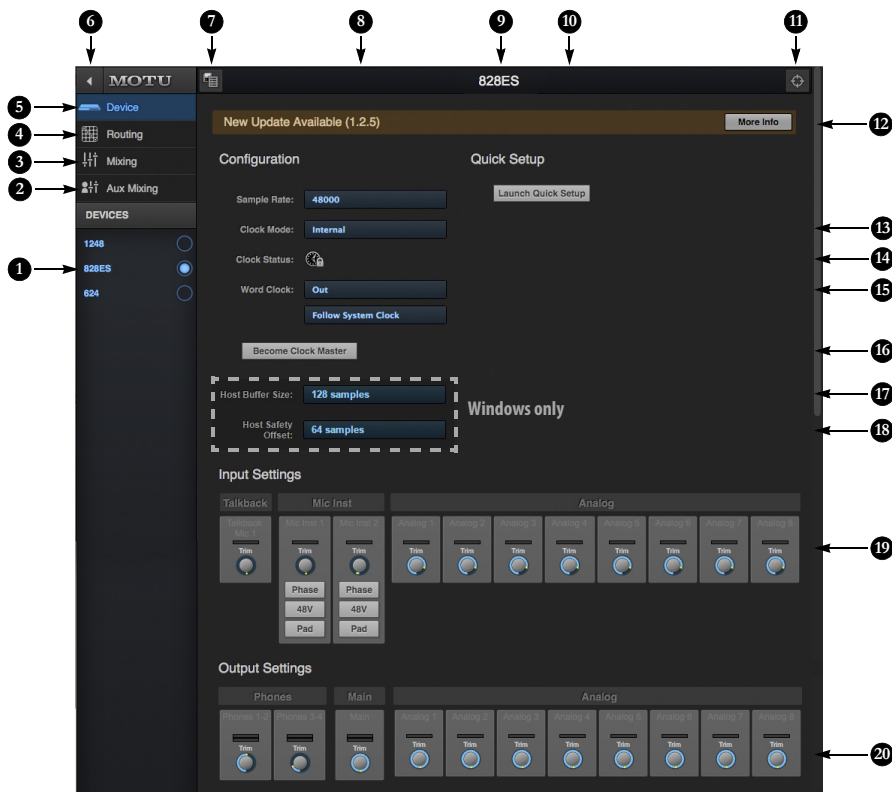

1. If you have two or more MOTU interfaces, the Devices list lets you choose the one you are currently controlling with the web app.
2. The Aux Mixing tab lets you view each Aux bus in the mixer, one at a time.
3. The Mixing tab gives you access to the mixing and DSP in the interface.
4. The Routing tab displays a grid matrix, where you can make direct connections between inputs and outputs, your computer, the mixer, and network audio streams, if networked interfaces are connected.
5. The Device tab has settings for the hardware itself, such as analog input and output trim.
6. Expands and collapses the sidebar.
7. Lets you create, save, recall and manage presets for the 828es. These presets capture and recall the complete state of the device (all settings in all tabs).
8. Choose the desired sample rate. Make sure your host audio software is set to the same rate.
9. Click to rename the interface. To restore the default name, delete the current name.
10. The Quick Setup button prompts factory presets used to configure your interface for a specific application. See chapter 6, "Presets" (page 53).
11. Click this device ID button to identify the unit you are currently viewing and controlling with the web app software. The front panel LCD on the hardware itself will flash the name of the device, and its name will also flash in the Device list (1).
12. If an update is available for your device, and the computer you are viewing it from is connected to the internet, you'll be notified here. Click More Info to learn what's new and start the update process. Firmware updating requires a USB or network connection to your computer. See Appendix D, "Updating Firmware" page (113).
13. Choose the clock source from the Clock Mode menu. Your MOTU device will resolve its digital clock to this master source.
14. The Clock Status icon indicates that the current device (1) is successfully resolved to its chosen Clock Mode source (13). If it cannot lock for some reason, this icon flashes red. Check your chosen clock source, cables, etc.
15. The Word Clock output on the your MOTU interface can operate as an OUT or a THRU. In addition, at higher sample rates, it can either follow the system clock or operate at the corresponding 1x sample rate. For details, see "Daisy-chaining word clock" on page 48.
16. If you have multiple MOTU interfaces, one of them may serve as a master clock source for the network.
17. (Windows only) Choose the Host Buffer Size. Smaller values reduce latency but increase your computer's CPU load. See "Host Buffer Size" on page 30.
18. (Windows only) Choose a Host Safety Offset to fine tune host buffer latency. See "Host Safety Offset" on page 31.
19. The Input Settings section provides gain settings for inputs and the built-in talkback mic, plus phase invert for the mic/guitar inputs. You can also toggle the 48V phantom power and -20 dB pad for the mic inputs.
20. The Output Settings section lets you adjust the trim for any outputs that support it. Phones and Main outputs provide full volume control. Analog outputs provide calibration control (-24 to 0 dB).



## DEVICE TAB (CONTINUED)

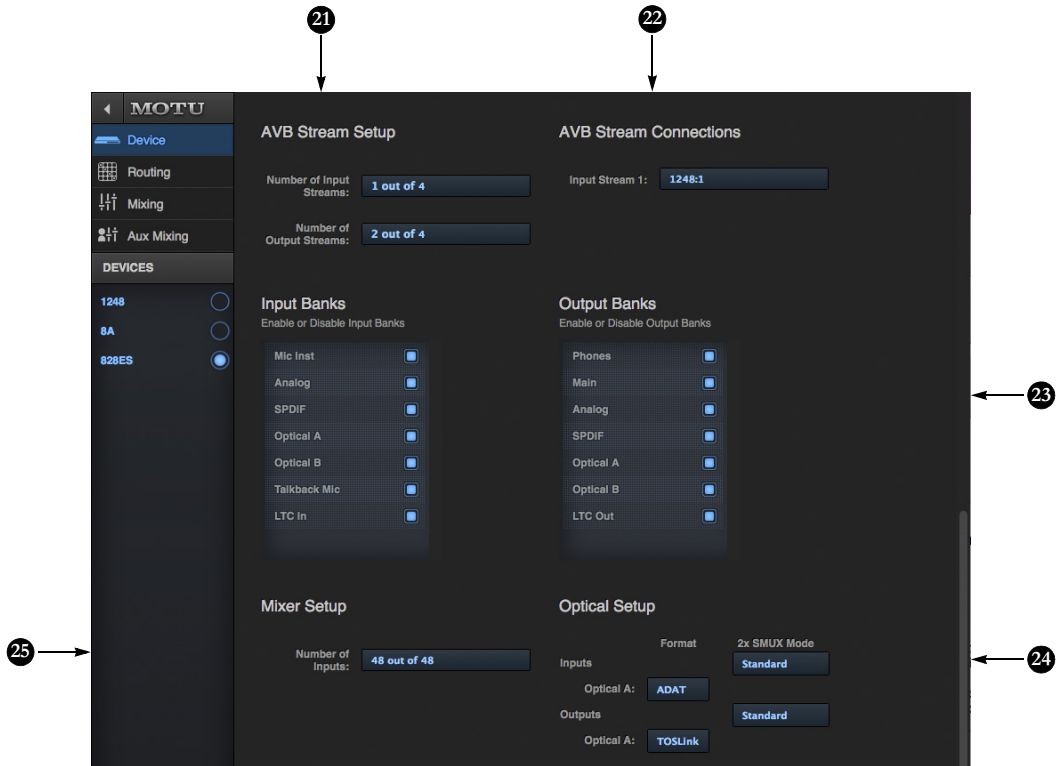

Scroll down to view these additional Device tab settings.

21. AVB is IEEE's Audio Video Bridging Ethernet standard for high-bandwidth, low-latency audio streaming over Ethernet. If your MOTU interface is connected to a 2nd MOTU interface through its network port, or to an AVB switch for access to an extended AVB network, you can stream audio channels to and from other devices on the network. AVB streams are handled in banks of eight channels, so if you enable 2 streams, that's 16 channels. See chapter 11, "Networking" (page 95).
22. If you've activated one or more AVB network input streams (21), connect them to the output streams of other devices on the network here. This is how you route audio from the other devices to the 828es.
23. In the Input/Output Banks sections, you can disable any banks that you are not using. Doing so hides them from the routing matrix and mixer to simplify operation. Doing so also helps conserve DSP resources.
24. Configure the optical ports for either 8-channel ADAT or stereo TOSLink. At 88.2 or 96 kHz, the ADAT setting supports 4-channel SMUX format. See "Optical I/O" on page 45.
25. The digital mixer in the 828es supports up to 48 channels at 44.1 or 48 kHz. At higher sample rates, the maximum number of supported channels is lower, due to finite DSP resources. If you don't need 48 inputs (or the maximum available), you can lower the number here to simplify mixer and routing operation and conserve DSP bandwidth for effects processing.

## DEVICE TAB (CONTINUED)

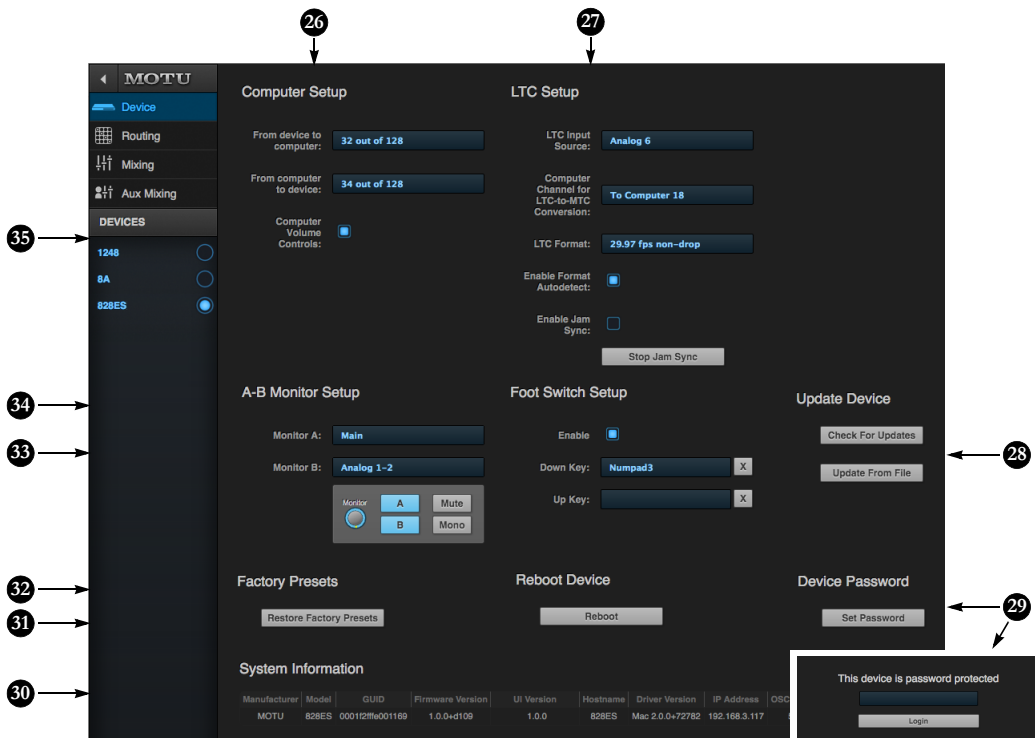

Scroll down to view these additional Device tab settings.

26. In the Computer Setup section, you can specify how many audio channels you would like to be able to stream to and from your computer, up to 128 channels each way, simultaneously, over USB or Thunderbolt. Map them as desired in the Routing tab (page 15).

27. Your MOTU interface can resolve to SMPTE time code, also referred to as LTC (*Longitudinal Time Code*), by choosing LTC from the Clock Mode menu (item 13 on page 12). From the LTC Input Source menu (27 above), choose the analog or digital input that is receiving the time code. If you would also like to send time code (LTC) to the computer, where it will be converted to MIDI Time Code (MTC) for resolving your DAW or other software to MTC via OS X Core Audio (a Mac-only feature), choose an audio channel you are not using for other purposes from the Computer Channel for LTC-to-MTC Conversion menu; otherwise, leave it set to None. Choose the desired frame format, or use the Enable

Format Autodetect to automatically detect the frame format of the incoming time code. When Enable Jam Sync is turned on, your interface will continue to operate under its own clock and continue LTC-to-MTC conversion, even after it stops receiving time code. Click Stop Jam Sync to exit this mode. For further details about time code sync, see “Syncing to SMPTE time code (LTC)” on page 48 and “LTC-to-MTC conversion” on page 69.

28. Use these buttons to manually check for and install updates for your MOTU interface. For complete details, see Appendix D, “Updating Firmware” page (113). Updating from a file can be done off line from your computer, using an update you’ve obtained through MOTU’s web site or tech support department. The Check For Updates button requires that the computer (or device) you are using to view your MOTU interface is connected to the internet through a local network or Wi-Fi. Updating from the internet is easy and convenient.

29. Use Set Password to password-protect the interface on the network. All settings are blocked, except for aux bus mixing, as shown above (29). This allows musicians to access their personal monitor (aux) mixes from their mobile devices, while all other device settings remain blocked. To clear the password, log in and then click Clear Password. If you forget the password, you can clear it in the Settings menu in the front panel LCD (see page 59) with either the Clear Password setting or by doing a factory reset with the Factory Default setting.

30. The System Information section displays information about your MOTU device, including the firmware version and network IP address.

31. Use Restore Factory Presets to restore your MOTU device’s factory presets.

32. Click Reboot to restart the interface.

33. Choose the outputs you would like to use for the front panel monitor controls (Monitor A/B switches,

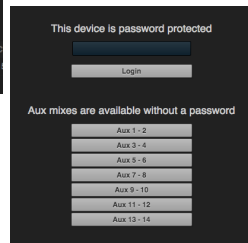

Mute and Mono). You can also control these functions here in the web app with the controls provided. See “Talkback” on page 60.

34. Enable the Foot Switch input here. In each text box, type the keystroke you wish to trigger from your foot pedal. Click ‘X’ to clear the text box.

35. When the Computer Volume Controls option is enabled (a Mac only feature), the Audio MIDI Setup utility in OS X provides volume control for each output channel to your MOTU audio interface. In addition, the volume controls for your Mac (on your computer keyboard) will control the channels you’ve designated for computer output in Audio MIDI Setup, if any. Be careful when toggling this setting because sudden changes in your computer volume can result.

## ROUTING TAB

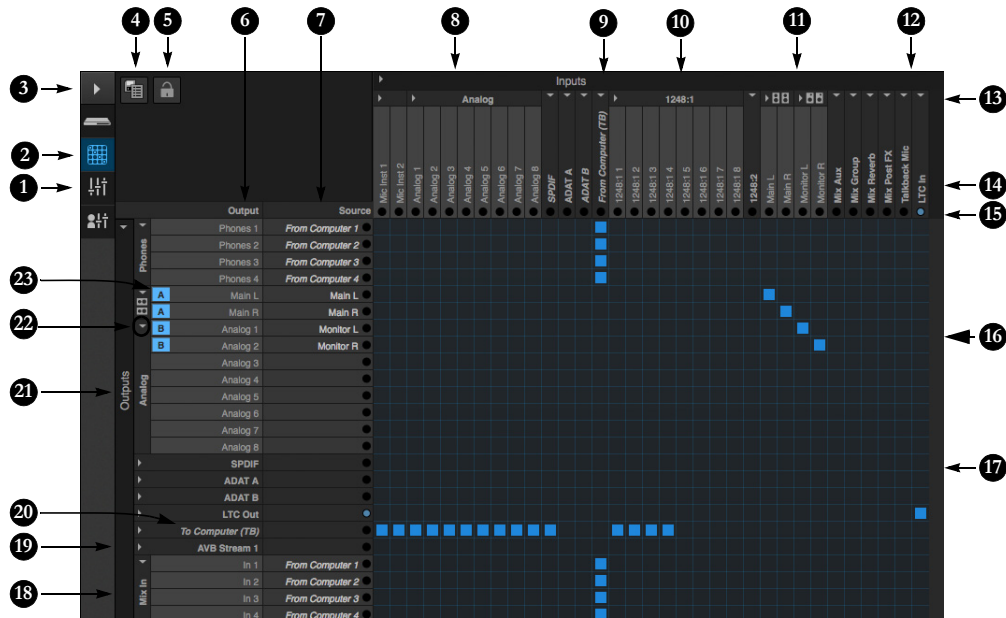

The Routing Tab lets you route inputs to outputs. Outputs are listed by row on the left; inputs are listed in columns across the top. Simply click in the grid to make a single connection. Click and drag to make multiple connections in one gesture. To route a single input to multiple outputs, make multiple connections vertically in the same column below the input. To mix multiple inputs to the same output, you'll need to use the mixer (page 16) and the *Mix In* bank in the routing tab (18).

1. In its collapsed form, (shown here), the sidebar displays icons for each tab.
2. Click this icon to view the Routing tab, shown on this page.
3. Click here to show or hide the sidebar.
4. Create, save, recall and manage routing presets.
5. Locks the grid to prevent accidental changes. Unlock to make changes to the grid.
6. Outputs are listed in rows on the left.

7. When you make a connection, the source (input) signal is listed by name here in the Source column, just to the right of the output it is being routed to.
8. Inputs are listed in columns across the top of the grid, starting with the physical inputs on the hardware itself. In this example, the analog inputs and S/PDIF digital inputs are being routed to the computer over Thunderbolt (TB).
9. The *From Computer* input bank lets you route audio channels from your host audio software to any output, including AVB network streams or the mixer, where you can mix computer audio with local inputs. Use the Device tab to choose how many computer channels are available.
10. AVB streams are 8-channel banks that let you route audio to or from other devices on the AVB network (if any are connected) to local hardware inputs and outputs. In this example, 8 channels of audio from a MOTU 1248 interface are available. The first four are being routed to the computer. Use the Device tab (page 13) to configure how many AVB streams you wish to work with.

If you aren't working with network audio, you can set the number of streams to zero to hide them from this grid (and the mixer).

11. These input streams are buses that originate from the mixer, which supplies the main mix bus, monitor mix bus, seven stereo aux buses, three stereo group buses, a reverb return bus and postFX channel sends (for sending processed inputs to the computer or elsewhere). You can route these mixer buses to any outputs you wish (6), including physical outputs, host software on your computer, other devices on the AVB network, or even back in to the mixer (beware of feedback loops!)
12. Use these two columns to route the talkback mic and time code input to any desired outputs. In this example, time code is being routed from the LTC input directly to the output.
13. Use these triangles to expand or collapse groups of inputs. For example, it might be convenient to collapse banks that you are not using at the moment.
14. Click a channel label to rename it.

15. Audio activity indicators.
16. Here, the Monitor bus from the mixer is being routed to analog outputs 1-2 (the Monitor B pair) on the 828es.
17. Click the grid to make a connection. Click a connection to remove it. Click and drag to make or break multiple connections in one gesture.
18. The *Mix In* group lets you route audio to the 48-channel mixer.
19. AVB output streams let you route any audio to other devices on the AVB network.
20. The *To Computer* output bank routes any input to host audio software running on your computer. Use the Device tab to choose how many computer channels are available.
21. These are the physical outputs on the interface itself.
22. Use these triangles to expand or collapse groups of outputs.
23. Indicate the outputs designated for A/B monitor switching (item #33 on page 14 and item #8 on page 9).

## MIXING TAB

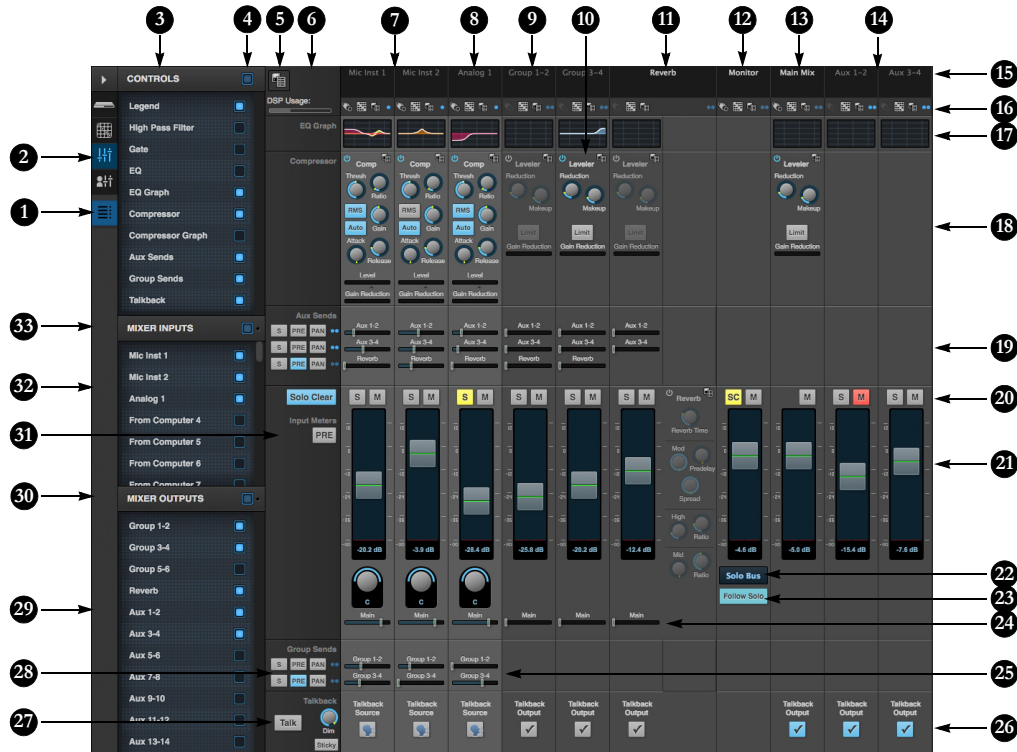

The Mixing tab gives you full access to the 48-channel mixer in the 828Es, which provides a main mix bus, monitor bus, three group buses, seven aux buses, and a dedicated reverb bus. Use the Device tab to configure how many inputs you wish to work with (up to 48). Use the Routing tab (page 15) to route channels to the mixer inputs. Channels can come from any source, such as the physical inputs on the interface, channels coming from the computer, or channels coming from the AVB network.

1. Shows and hides the Mixer Setup sidebar (3), which lets you show and hide channels, channel strip settings, effects, and the Legend (6).
2. The Mixing tab selects the mixer.
3. Use the Mixer Setup sidebar to show and hide elements in the mixer.
4. Shows and hides all elements in the section with one click.
5. Create, save, recall and manage mixer presets.
6. This column is the Legend. It provides labels and controls for channel strip sections. The menu at

the top lets you create, name, save and manage entire mixer presets.

7. Mixer input channels.
8. This input channel has an EQ shelf filter enabled.
9. This is Group bus 1-2. You can send inputs to this group with their Group send fader (25). Groups are sent to the Main Mix with its Main send fader (24) or aux buses (19).
10. Group buses, the main mix bus, and the reverb return bus are equipped with the Leveler, a vintage compressor modeled after the Teletronix LA-2A leveling amplifier.
11. The reverb channel strip provides the reverb processor. Use the reverb send on inputs or groups to route them to the reverb bus, which can then be mixed in with the main mix or aux busses. Disable the reverb processor to use it as an extra group.
12. The Monitor Bus can mirror the output of any other bus, or it can act as a separate Solo bus. See page 19.

13. The Main Mix bus is the master fader for the entire mixer. You can add EQ and Leveler compression.

14. You can adjust Aux bus output levels here, or in the Aux Mixing tab shown on page 17.
15. Click a name to change it, except for the Main Mix, Monitor, and Reverb busses, which cannot be changed.
16. Stereo toggle to switch channels pairs between mono or stereo. Use the other menus to manage channel strip presets and to choose audio sources and destinations for mixer inputs and bus outputs.
17. Click the thumbnail EQ graph to open the full-size, editable EQ graph (Figure 9-4 on page 73).
18. The Dynamics section provides a conventional compressor for inputs and the Leveler for output busses.
19. Reverb and aux sends.
20. Solo and mute. On the Monitor bus, the SC button clears all solos.

21. Channel faders.

22. Choose the source for the Monitor bus from this menu. It can mirror any output bus or the Solo Bus.
23. When *Follow Solo* is enabled, the Monitor bus temporarily switches to the solo bus when any channel is soloed.
24. Main Mix sends.
25. Group sends.
26. See "Talkback setup" on page 60.
27. See "Talkback settings" on page 61.
28. 'S' lets you solo the group. 'PRE' toggles the sends between pre- and post-fader routing, i.e. before or after the channel fader.
29. Show and hide output busses here.
30. Show/hide all busses with one click.
31. Same as (28) above.
32. Show and hide inputs here.
33. Show/hide all inputs with one click.

## AUX MIXING TAB

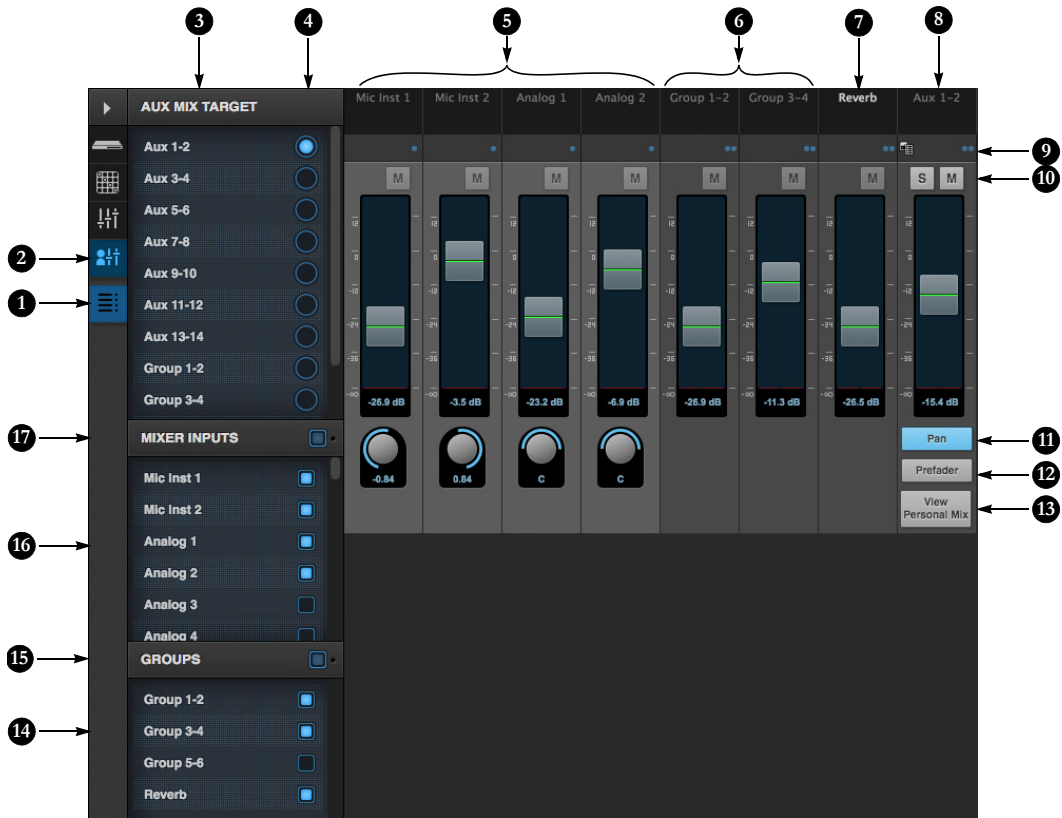

The Aux Mixing tab provides quick access to the 828es mix buses (aux buses, groups and reverb bus), viewed one at a time. Choose a bus in the Aux Mix Target section (3) and then use the faders to directly mix the send levels from all mixer inputs, groups, and the reverb bus.

- Shows and hides the Mixer Setup sidebar (3), which lets you show and hide channels.
- The Aux Mixing tab (shown on this page) gives you access to the Aux buses and groups in the mixer.
- Use the *Aux Mix Target* sidebar to control which aux bus or group you are currently viewing. You can also show/hide inputs and group sends.
- Click the aux bus or group you wish to view in the window. In this example, Aux bus 1-2 is being displayed.
- These are mixer inputs (aux sends from each mixer channel). To include an input in the aux bus mix, simply bring up its fader.
- These are group bus faders.
- This is the mixer's reverb bus fader.
- This is the master fader for the current aux bus being viewed (4).
- Indicates if the input or group is stereo or mono. This indicator is for display purposes only. To toggle between mono and stereo operation, use the toggle switch in the Mixing tab (item #16 on page 16).
- Solo and mute for the aux bus master fader. The mute buttons for the input channels and other buses are for display purposes only, so that you can see if they are muted or not (in the mixer).
- Shows and hides the pan controls for aux bus inputs.
- When *Prefader* is enabled, all send levels to the aux bus are independent of the main fader for each channel. In other words, changing an individual channel's main fader in the Mixing tab won't affect its send level to the aux bus.
- Click the *View Personal Mix* button to open a new web page that displays only that specific Aux Mix or Group.
- Show and hide mix groups and the reverb bus here.
- Use the Groups button here to show or hide all groups with one click. Drag this section divider vertically to resize the list.
- Show and hide mixer inputs (channel sends) here.
- Show and hide all mixer inputs with one click here. Drag this section divider vertically to resize the list.

## MIXER INPUT CHANNEL STRIPS

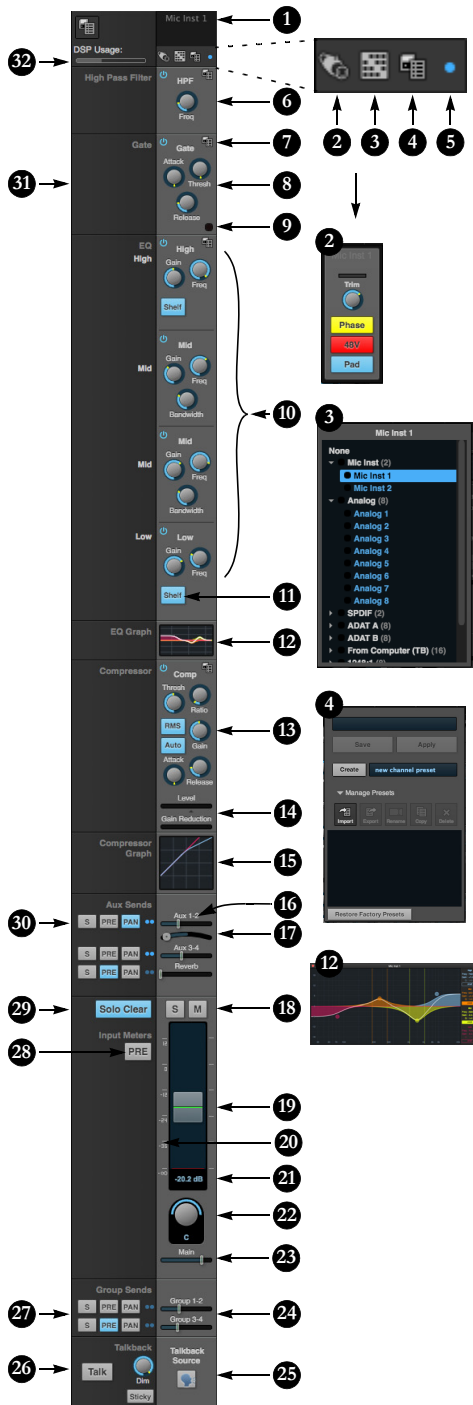

To access a mixer input channel strip, go to the Mixing tab (page 16), reveal the side bar (item #3 on page 16), and show the input channel in the *Mixer Inputs* section (32). To show and hide sections of the channel strip, such as EQ or the compressor, use the *Controls* section of the side bar (item #3 in the Mixing tab on page 16).

1. Click the input channel name to change it. Delete the current name to restore the default name.
2. Provides hardware settings for inputs, if any, such as preamp gain. If there are no hardware settings for the assigned input, this icon is grayed out. If the channel has been assigned to an input on another AVB device on the audio network, you can use these settings to control it remotely.
3. Choose the source for the input channel. You can also make this setting directly on the Routing grid (page 15).
4. Create and recall channel strip presets.
5. Toggles the input between mono and a stereo pair.
6. High Pass Filter with cutoff frequency.
7. Each effect in the channel strip (High Pass Filter, Gate, EQ, etc.) has an on/off button on the left and a preset menu on the right, for managing presets that apply only to that processing module. For example, you can create your own EQ presets for the EQ modules.
8. The Gate processor provides standard attack, threshold and release controls.
9. The Gate indicator turns red when the gate is engaged.
10. The EQ section provides four bands of parametric EQ, each with standard Gain, Frequency, and Bandwidth settings.
11. The High and Low EQ bands provide a *Shelf* filter button for standard high and low shelf filtering.
12. The thumbnail EQ Graph displays the currently enabled EQ filters, if any. Click it to open the full-size, editable EQ Graph (Figure 9-4 on page 73).
13. The Compressor provides standard controls for Threshold, Ratio, Attack, Release and Gain. Normally, the compressor operates in Peak mode, where signal peaks determine the input level. Engage the *RMS* button to use RMS values (a computational method for determining overall loudness) for the input level. Engage *Auto* makeup gain to compensate for any gain reduction.
14. Input level and gain reduction meters for the compressor.
15. The thumbnail Compressor Graph provides a graphic representation of the compressor, when enabled. Click it to open the full-size, editable Compressor Graph (Figure 9-6 on page 74).
16. Aux 1-2 send.
17. Pan for the Aux 1-2 send. This is enabled in the Aux mix tab (item #11 on page 17).
18. Solo/Mute. Mute affects all sends as well as the main channel. Pre-fader sends are not affected by Mute.
19. Move the fader to adjust level. Double-click to return to zero (unity gain) or  $\infty$ .
20. Click the dB scale numbers to make the fader jump exactly to that level. Click and drag horizontally to jump consecutive faders to the same level.
21. Click to type in an exact dB level.
22. Channel pan. For mono inputs, double-click to center.
23. Main Mix Slider feeds signal to the Main Mix. Slider is set to 0 dB by default, so all channel strips are pre-routed to the Main Mix bus. If a channel is being sent to a Group (which will eventually be fed to the Main Mix), drag the slider to  $\infty$  so it is not sent to Main Mix directly.
24. Group sends.
25. Makes the input the source for talkback.
26. See "Talkback settings" on page 61.
27. 'S' lets you solo the group. 'PRE' toggles the sends between pre- and post-fader routing, i.e. before or after the channel fader. PAN enables pan for group sends.
28. The input level meter (behind the fader handle, 19) can display either pre- or post-fader levels. Toggle here.
29. Clears all solos.
30. 'S' lets you solo the Aux bus. 'PRE' toggles the sends between pre- and post-fader routing, i.e. before or after the channel fader. The dots let you toggle the Aux bus between mono and stereo.
31. This side bar, with the section labels in it, can be shown or hidden using the *Legend* switch in the *Controls* section of the side bar (item #3 in the Mixing tab on page 16).
32. Shows how much DSP power is being used by the mixer hardware. To free up DSP bandwidth, try reducing the number of mixer ins, disabling channel effects, reverb, etc. See "DSP Usage" on page 77 for more info.



## MAIN MIX AND MONITOR CHANNEL STRIPS

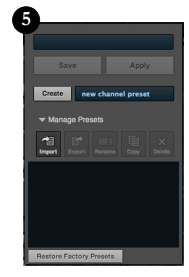
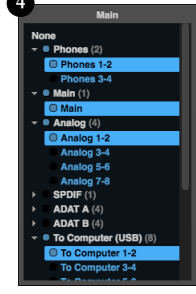
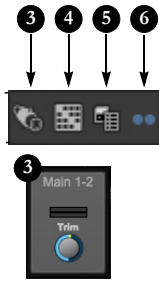
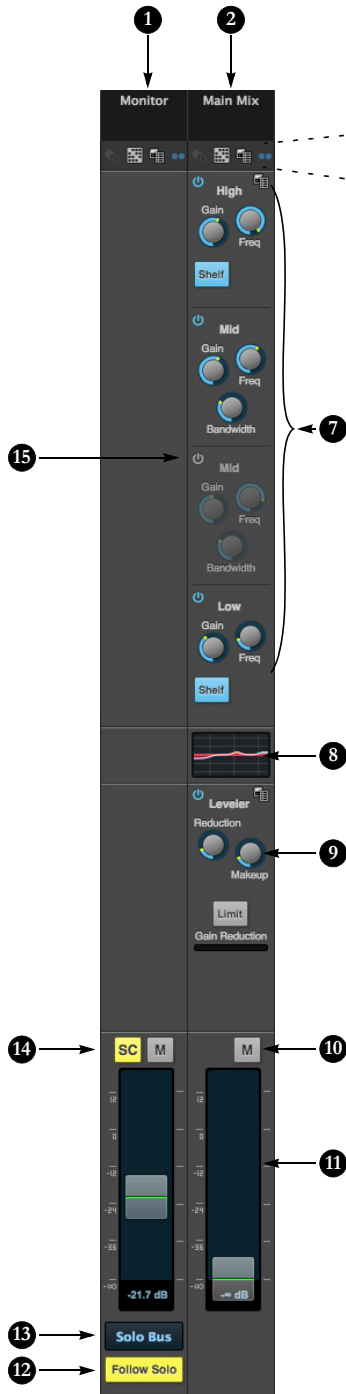

To access the Main Mix and Monitor bus channel strips, go to the Mixing tab (page 16) and scroll the display to the right, beyond the inputs and groups.

To show and hide sections of the channel strip, such as EQ or the Leveler, use the *Controls* section of the side bar (item #3 in the Mixing tab on page 16).

1. By default, the Monitor bus serves as a solo bus. However, it can be set to mirror the main mix bus, or any other aux bus, group, or the reverb bus, in addition to monitoring solo. Make this choice in the source menu (13) to specify the output for the Monitor bus.

2. The Main Mix bus is the primary stereo mix.

3. Provides hardware settings for any assigned outputs that have them. For example, if the Main Mix bus is assigned to the Main Outs on the 828es, you'll see trim settings for the outputs. This item is grayed out if there are no hardware settings for output.

4. Use this output assignment widget to choose the destination — or multiple destinations — for the bus. You can also make this setting directly on the Routing grid (page 15).

5. Use the preset menus to create save, recall, and otherwise manage channel strip presets for the Monitor bus and Main Mix bus.

6. Indicates that the bus is stereo.

7. The four-band parametric EQ for the Main Mix bus operates the same as described for input channels (items 10 and 11 on page 18), including High and Low Shelf filter options.

8. The thumbnail EQ Graph displays the currently enabled EQ filters, if any. Click it to open the full-size, editable EQ Graph (Figure 9-4 on page 73).

9. The Leveler provides specialized gain reduction modeled after the legendary Teletronix LA-2A Leveling Amplifier. For complete details, see "Leveler" on page 75.

10. Mutes for the Main Mix bus and Monitor bus.

11. Master faders for the Main Mix bus and Monitor bus. Use the same techniques described for input channel faders (items 19, 20 and 21 on page 18).

12. When *Follow Solo* is enabled, the Monitor bus switches to the solo bus when any channel is soloed. NOTE: if an aux bus is soloed, then the Monitor bus carries only the soloed aux bus (any current channel solos are excluded).

13. Choose the source for the Monitor bus from this menu. It can mirror the main mix, any aux bus, group, the reverb bus, or it can serve only as a Solo bus.

14. The SC button clears all solos.

15. This mid-band EQ is currently disabled (and therefore grayed out).

## AUX BUS CHANNEL STRIPS



Aux buses can be used to create sub-mixes. An aux bus can be assigned to any output in the Routing grid (page 15).

To access an Aux bus channel strip, go to the Mixing tab (page 16), reveal the side bar (item #3 on page 16), and then show the aux buses you want in the *Mixer Outputs* section (29).

To show and hide the four-band EQ section of the channel strip, use the *Controls* section of the side bar (item #3 in the Mixing tab on page 16).

1. A stereo aux bus.
2. A mono aux bus.
3. Click this dot to toggle an aux bus between mono and stereo.
4. The four-band parametric EQ module for Aux buses operates the same as described for input channels (items 10 and 11 on page 18), including High and Low Shelf filter options.
5. The thumbnail EQ Graph displays the currently enabled EQ filters, if any. Click it to open the full-size, editable EQ Graph (Figure 9-4 on page 73).
6. Aux bus solo and mute.
7. Aux bus master fader.
8. Click to type specific value manually.
9. Click to route the talkback mic to the aux bus output.
10. Click the dB scale numbers to make the fader jump exactly to that level. Click and drag horizontally to jump consecutive faders to the same level.
11. A disabled EQ band.
12. Use these menus (hardware settings, output assignment, and presets) in a similar fashion as described for the Main Out bus (items 3-5 on page 19).



## GROUP AND REVERB CHANNEL STRIPS

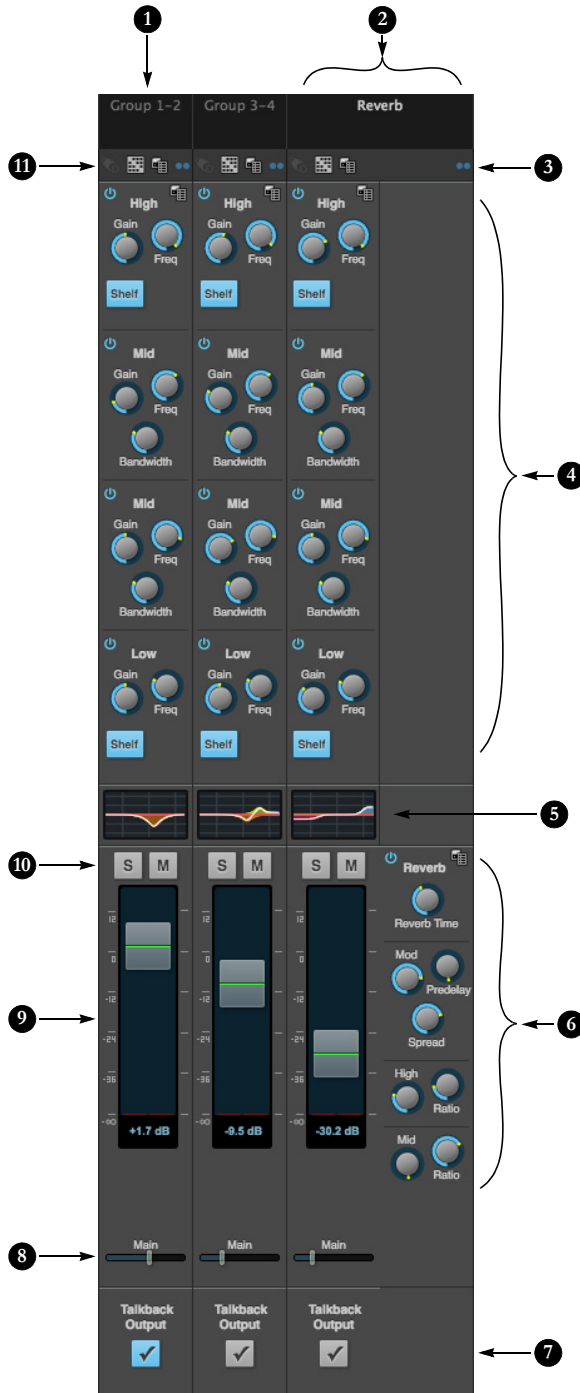

Group busses can be used to create a mix sub-group, which is a set of inputs you wish to control together as a group. Groups differ from aux busses in that they have aux sends, a reverb send, as well as a main mix send. In addition, group busses are equipped with the Leveler.

The Reverb bus is a special group bus that provides a reverb processor. If you disable the reverb, the reverb bus functions as a (fourth) regular group bus.

To access the Group and Reverb bus channel strips, go to the Mixing tab (page 16), reveal the side bar (item #3 on page 16), and then show the desired Group buses or Reverb bus in the *Mixer Outputs* section (29).

To show and hide the four-band EQ section of the channel strip, use the *Controls* section of the side bar (item #3 in the Mixing tab on page 16).

1. A Group bus channel strip. Click the name to rename it. Delete the current name to return to its default.
2. The Reverb bus. If you disable the Reverb processor, it can be used as a fourth Group bus. The Reverb channel strip is twice as wide as other mixer channel strips to accommodate the Reverb processor controls.
3. Group busses and the Reverb bus are always stereo.
4. The four-band parametric EQ module for Group buses and the Reverb bus operates the same as described for input channels (items 10 and 11 on page 18), including High and Low Shelf filter options.
5. The thumbnail EQ Graph displays the currently enabled EQ filters, if any. Click it to open the full-size, editable EQ Graph (Figure 9-4 on page 73).
6. The Reverb processor. For complete information, see “Reverb” on page 76.
7. Click to route the talkback mic to the group output.
8. Main Mix sends.
9. Master faders for the Group and Reverb busses.
10. Mute and Solo.
11. Use these menus (hardware settings, output assignment, and presets) in a similar fashion as described for the Main Out bus (items 3-5 on page 19).



## CHAPTER 2 About the 828es

The 828es is a 28 x 32 Thunderbolt/USB/AVB audio interface with console-style 48-channel mixing, DSP effects, wireless control, AVB audio networking and very high quality A/D/A conversion at sample rates up to 192 kHz for on-the-go mobile audio recording.

Powerful DSP delivers large console style mixing with 48 channels, 12 stereo busses, and 32-bit floating point effects processing, including modeled analog EQ, vintage compression and classic reverb. Matrix routing lets you quickly patch ins to outs, or split inputs to multiple destinations.

The 828es can operate as an audio interface for a studio workstation (DAW), as a standalone mixer, or as an auxiliary monitor mixing system in the studio or on stage. The following sections provide a brief overview of its main features and characteristics.

### Comprehensive I/O

The 828es provides a variety of analog and digital interconnects, all active simultaneously, designed to provide everything you need for a well-equipped recording studio.

Connection	Input	Output
Quarter-inch analog on bal/unbal TRS	8	8
Mic/guitar on XLR/TRS combo	2	-
Main outputs on XLR	-	2
Headphone output	-	2 x stereo
ADAT optical digital†	16	16
RCA S/PDIF 24-bit 96kHz digital	stereo	stereo
<b>Total</b>	<b>28</b>	<b>32</b>

† The 828es optical connectors support several standard optical I/O formats, which provide varying channel counts. See “Optical I/O” on page 45 for details about optical bank operation.

All inputs and outputs are discrete. For example, using a mic input does not “steal” an input from the TRS analog I/O bank.

### Network I/O

828es is capable of handling four 8-channel banks of network audio input and output for an additional 32 channels of network I/O.

### Other MOTU interfaces

The 828es is part of a larger family of audio interfaces that offer complementary I/O configurations. For details, visit [motu.com](http://motu.com).

### Universal connectivity

The 828es can connect to a computer with Thunderbolt or hi-speed USB 2.0, which is compatible with USB 3.0. It is USB audio class-compliant, which means that it is iPad compatible (with a camera connection kit) and does not require driver installation for USB connection to a computer.

Alternately, the 828es can be connected to the Ethernet port on a recent-generation Mac (any Mac with Thunderbolt on it) running Mac OS X El Capitan (10.11) or later for audio interface operation through AVB Ethernet.

### Mic/guitar inputs with preamps

The two front-panel mic/line/instrument inputs are equipped with preamps and “combo” XLR/TRS jacks, which accept XLR microphone inputs or quarter-inch line/instruments inputs. Individual 48 volt phantom power and a -20 dB

pad can be supplied independently to each mic input. The Precision Digital Trim™ knobs on the front panel for each mic/instrument input provide up to 63 dB of boost in precise 1 dB increments.

As explained in “Mic/guitar sends” on page 24, the pre-amplified signal can be routed to external outboard gear before being routed back into the 828es.

### **Mic/guitar sends**

Before A/D conversion, the pre-amplified signal from each front-panel mic/guitar input is routed to one of the two rear-panel quarter-inch analog sends, so that you can insert a favorite outboard EQ, compressor, amp or effects processor to the mic/guitar input signal before it is converted to digital form. The resulting output from the outboard gear can be fed back into the 828es via one of the eight TRS analog inputs on the rear panel, for routing to the computer and/or inclusion in the 828es built-in monitor mixes.

### **Flexible analog I/O with Precision Digital Trim™**

All quarter-inch analog inputs can accept either a balanced or unbalanced plug. The quarter-inch outputs are DC-coupled, so they can be used for CV control output.

Analog inputs are equipped with digitally controlled analog trims, adjustable in 1 dB increments. Equipped with renowned ESS Sabre32™ DAC technology, all analog outputs offer 32-bit trim in the DAC, also adjustable in 1 dB increments. You can save your trim configurations as a preset for instant recall.

### **Independent XLR main outs**

The XLR main outs are equipped with very high quality ESS Sabre32 D/A converters and serve as independent outputs for the computer or the 828es on-board mixer.

### **On-board DSP with mixing and effects**

828es is equipped with a powerful DSP engine that drives both an extensive routing matrix and a 48-input digital mixer with 12 stereo buses and effects. The mixer offers familiar operation modeled after large format mixing consoles.

### **32-bit floating point processing**

All of the mixing and effects processing in the DSP engine is handled with 32-bit floating point calculations, to maintain and deliver virtually unlimited headroom and the utmost in sound quality.

### **Modeled vintage effects processing**

Effects include “classic” reverb, compression modeled after the legendary Teletronix LA-2A compressor, and 4-band EQ modeled after British analog console EQs.

### **AVB/TSN system expansion and audio networking**

AVB stands for the IEEE 802.1 *Audio Video Bridging* Ethernet standard for high-bandwidth, low-latency audio streaming over Ethernet. You may also hear AVB referred to as AVB/TSN or simply TSN because the IEEE is in the process of renaming the standard to *Time Sensitive Networking* to accommodate the expanding scope of the specification to applications beyond audio and video.

The AVB Ethernet network port on the 828es lets you add a second AVB-equipped MOTU interface using any standard CAT-5e Ethernet cable. You can network up to five MOTU interfaces together using a MOTU AVB Switch™ (sold separately), and then run them as a stand-alone network or as an extended bank of I/Os for your computer-based production system (or both). You can even connect multiple computers, each with full access to all devices on the network (including the other computers).

With additional standard AVB switches (from MOTU or other brands) and standard Ethernet cabling, you can build an extensive AVB audio network. The entire network operates with near-zero network latency, even over very long cable runs. MOTU’s AVB implementation allows you to stream hundreds of audio channels among devices and computers on the network with guaranteed Quality of Service (QoS), prioritizing audio streams over less important traffic.

### **Matrix routing and multing**

The 828es provides completely flexible matrix-style audio routing and multing. You can route any analog or digital input, computer channel, or network stream to any other output, computer, or network device. You can also mult any single input to unlimited multiple output destinations.

### **Web app control**

You can control the 828es on-board DSP, mixing, device settings, clock/sync settings and network audio routing from the MOTU Pro Audio Control web app software running in your favorite browser on a laptop, tablet or smart phone. Multiple devices can be used simultaneously on a shared Wi-Fi network to access any audio interface settings. Optional password protection prevents unauthorized access from the network.

### **Stand-alone mixing with wireless control**

If you connect the 828es to an Apple Airport or other Wi-Fi router with a standard Ethernet cable, you can control its powerful mixing and DSP effects from your smart phone or tablet, without a computer — great for live sound mixing from your iPad, tablet, or other wireless device.

### **ADAT digital input**

The 828es provides two 8-channel banks of optical digital I/O. Connect outboard digital processors, digital mixers or other gear: 16 channels at 44.1/48 kHz or 8 channels at 88.2/96 kHz. Alternately, the optical ports can be independently configured to

support stereo TOSLink (optical S/PDIF). The banks operate independently, including input and output, allowing you to mix and match any optical formats. For example, you could receive four channels of 96 kHz S/MUX input on Bank A while at the same time sending 96 kHz stereo optical S/PDIF (“TOSLink”) from the Bank A output.

### **S/PDIF**

The 828es rear panel provides S/PDIF input and output in two different formats: RCA “coax” and optical “TOSLink”. The RCA jacks are dedicated to the S/PDIF format. The TOSLink jacks can be used for either TOSLink or ADAT optical, as discussed earlier.

### **MIDI I/O**

The standard MIDI IN and MIDI OUT jacks supply 16 channels of MIDI I/O to and from the computer via the Thunderbolt or USB connection. Timing accuracy can be sample-accurate with host software that supports it.

### **On-board SMPTE synchronization**

The 828es can resolve directly to SMPTE time code via the quarter-inch SMPTE input, without a separate synchronizer. A SMPTE out jack is also provided for time code distribution. The 828es provides a DSP-driven phase-lock engine with sophisticated filtering that provides fast lockup times and sub-frame accuracy.

### **Word clock**

The 828es supports standard word clock synchronization at any supported sample rate. When the 828es is operating at 96 kHz, it can generate word clock output at either 96 or 48 kHz. Half-rate output is supported for all high sample rates (from 88.2 to 192 kHz).

### **Foot switch input**

The quarter-inch foot switch input accepts a standard foot switch. When you push the foot switch, the 828es triggers a programmable keystroke on the computer keyboard. For example, with MOTU's Digital Performer audio sequencer software, the foot switch could trigger the 3 key on the numeric keypad, which toggles recording in Digital Performer. Therefore, pressing the foot switch is the same as pressing the 3 key. The 828es web app software lets you program any keystroke you wish.

### **Full-color dual-LCDs**

The full-color dual-LCDs display all signal activity at a glance with vivid, detailed metering for all I/O. You can access many hardware settings directly from the front panel.

### **Two independent headphone outputs**

The 828es front panel provides two independent headphone jacks with separate volume control. You can program each phone output to mirror another set of outputs or act as its own independent output.

### **Rack mount or desktop operation**

The 828es is housed in a sturdy, metal-alloy full-rack enclosure. Rack mounting brackets can be removed for desktop or mobile operation.

### **AudioDesk**

AudioDesk is a full-featured audio workstation software package for Mac and Windows that is available as a free download for you as an 828es owner. Visit [motu.com/download](http://motu.com/download) to obtain your copy. AudioDesk provides multi-channel waveform editing, automated virtual mixing, graphic editing of ramp automation, real-time effects plug-ins with crossfades, support for many third-party audio plug-ins, sample-accurate editing and placement of audio, and more.

## CHAPTER 3 **Packing List and System Requirements**

### **PACKING LIST**

the 828es ships with the items listed below. If any of these items are not present in the box when you first open it, please immediately contact your dealer or MOTU.

- One audio interface
- USB cable
- Power cord
- User guide
- Product registration card

### **SYSTEM REQUIREMENTS**

- A 1 GHz Intel-based Mac or Pentium-based PC (or compatible). Faster CPUs are recommended for best performance.
- 2 GB RAM; 4 GB or more recommended.
- OS X 10.8 or later; Windows 7 or later; for operation as an AVB Ethernet audio interface, Mac OS X 10.11 or later is required, running on a recent-generation Mac (any Mac with a Thunderbolt port on it).
- Available Thunderbolt or high-speed USB 2.0 (or 3.0) port.
- A large hard drive (preferably at least 512 GB).

### **PLEASE REGISTER TODAY!**

Please register the 828es today. There are two ways to register.

- Visit [www.motu.com/register](http://www.motu.com/register)

OR

- Fill out and mail the included product registration card

As a registered user, you will be eligible to receive technical support and announcements about product enhancements as soon as they become available. Only registered users receive these special update notices, so please register today.

Thank you for taking the time to register your new MOTU products!





# CHAPTER 4 Software Installation

## OVERVIEW

USB audio class-compliant operation .....	29
Software installation .....	29
Audio drivers .....	30
MOTU Discovery app .....	31
MOTU Pro Audio WebUI Setup for Windows.....	31
AudioDesk workstation software .....	31
Working with host audio software .....	31

## USB AUDIO CLASS-COMPLIANT OPERATION

The 828es is a USB audio class-compliant device. This means that you can connect it to your Mac (running Mac OS 10.8 or higher) with a USB cable and use it without installing any software drivers. The computer recognizes the 828es as a USB audio device and makes its inputs and outputs available to your host audio software. Basic settings, such as the hardware’s sample rate, are made in either your host software.

 In this scenario, the 828es provides basic audio input and output, and no software driver installation is necessary.

### Connection to iOS devices (iPad and iPhone)

Audio-class compliant operation allows you to connect the 828es to any iOS device with a standard camera connection kit adapter. The 828es then provides multi-channel audio I/O to your audio apps. Use your audio app to configure the number of available audio channels.

### Web app control

As explained earlier in this guide, the MOTU Pro Audio Control web app provides full access to all settings in the device, including the extensive on-board routing, mixing, and effects processing features. Since the web app is served from the audio interface hardware itself, it does not require any software installation on your computer; all it

requires is a network connection between your computer and the 828es with a standard Ethernet cable, Ethernet hub, or shared Wi-Fi network. For details about accessing the web app through the network port, see “MOTU Pro Audio Control Web App” on page 11.

## SOFTWARE INSTALLATION

Software installation is required for any of the following scenarios:

- You are using a PC running Windows 7 or later.
- You will use the 828es as a Thunderbolt audio interface with your Mac or PC.
- You will use 828es as a USB audio interface, and you want to access the web app without a network connection between the computer and the 828es.
- You will be using multiple MOTU interfaces.

If none of the above scenarios apply to you, then you can skip software installation if you wish, and proceed to details about accessing the web app through the network port, see “MOTU Pro Audio Control Web App” on page 11.

### Download and run the MOTU Pro Audio Installer

To download the latest MOTU Pro Audio installer for Mac or Windows, visit [www.motu.com/](http://www.motu.com/) download. Follow the directions that the installer gives you.

 We recommend that you run the software installer *before* you connect the 828es to your computer and power it on. This ensures that all driver components are properly installed in your system.

## AUDIO DRIVERS

The installer provides Thunderbolt and USB audio drivers for Mac (CoreAudio) and Windows (ASIO and Wave).

### Thunderbolt support for Mac and Windows

You can connect your MOTU interface to a Thunderbolt-equipped PC and access up to 128 channels of simultaneous audio input and output using the MOTU Pro Audio ASIO driver. On Mac OS, the MOTU Pro Audio Core Audio driver provides similar high-bandwidth Thunderbolt I/O for Mac audio applications. On both Mac and Windows, you will enjoy access to very low buffer settings and extremely low I/O latency performance from your host audio software.

☞ Check [motu.com/support](http://motu.com/support) for the latest information regarding PC Thunderbolt compatibility, as some PC products are not yet qualified for use with MOTU Thunderbolt-equipped audio interfaces.

### Industry-leading I/O latency performance

On Mac OS and Windows, the MOTU Pro Audio driver provides exceptionally low I/O latency performance for both Thunderbolt and USB operation. For example, with a 32-sample buffer size, an 828es interface operating at 96 kHz produces round trip latency (RTL) performance of 1.9 milliseconds (ms) over Thunderbolt on Windows and 1.6 ms on Mac OS. RTL is the measurement of the time it takes audio to pass from an analog input, through a high-performance DAW host such as Digital Performer, to an analog output.

### MOTU Pro Audio ASIO Driver

On Windows, to enable the 828es in your ASIO host software, choose the MOTU Pro Audio ASIO driver.

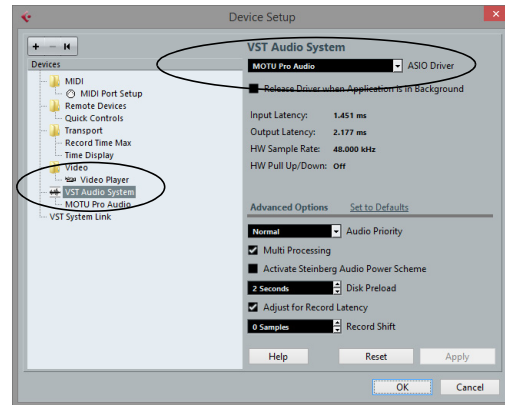

Figure 4-1: Choosing the MOTU Pro Audio ASIO driver in Cubase.

### WDM / Wave driver support

On Windows, the MOTU Pro Audio driver includes stereo and multi-channel support (up to 24 channels) for WDM (Wave) compatible audio software.

### Host Buffer Size

When connected to a Windows host, the *Host Buffer Size* menu (Figure 4-2 on page 31) is available in the Device tab (page 12). This setting determines the amount of latency (delay) you may hear when live audio is patched through your Windows audio software. Smaller buffer sizes produce lower latency, with sizes of 256 samples or less producing virtually imperceptible delay. Many host applications report audio hardware I/O latency, so you can see what happens to the reported latency when making adjustments to this setting.

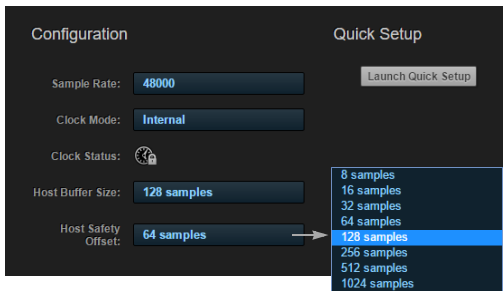

Figure 4-2: Under Windows, access the ‘Host Buffer Size’ and ‘Host Safety Offset’ settings in the web app Device tab for your MOTU interface.

Be careful with very small buffer sizes, as they can cause performance issues from your host software or PC.

☞ At sea level, audio travels approximately one foot (30 cm) per millisecond. A latency of ten milliseconds is about the same as being ten feet (three meters) from an audio source.

### Host Safety Offset

When connected to a Windows host, the *Host Safety Offset* menu (Figure 4-2) also becomes available. This setting allows you to fine tune host latency. Larger offsets allow the driver more time to process audio as it transfers to and from the hardware. Lower settings produce lower latency, but if you go too low, your host software may experience performance issues. Generally speaking, 48 samples should serve as a good baseline setting. You can then experiment with lower settings from there. Be mindful, however, when reducing the safety offset, as this parameter can have a significant impact on your computer system’s performance.

### MOTU DISCOVERY APP

The MOTU Discovery app (found in the Mac menu bar or Windows taskbar) locates all MOTU interfaces connected to the computer, either directly through USB or Thunderbolt or indirectly through your network, and displays them in a list.

Choose an interface to access its settings through the web app (“MOTU Pro Audio Control Web App” on page 11).

### MOTU PRO AUDIO WEBUI SETUP FOR WINDOWS

On Windows, the installer provides a *MOTU Pro Audio WebUI Setup* shortcut found on the Windows desktop or in *Start menu > All Programs > MOTU*. Use this shortcut to access the MOTU Pro Audio Control web app directly in your favorite web browser.

### AUDIODESK WORKSTATION SOFTWARE

AudioDesk is an advanced workstation software package for Mac and Windows that lets you record, edit, mix, process, bounce and master multi-track digital audio recording projects. Advanced features include real-time effects processing, recording, and much more.

See the *AudioDesk User Guide*, available on your computer hard drive as a PDF document.



Figure 4-3: AudioDesk.

### WORKING WITH HOST AUDIO SOFTWARE

For further information about using the 828es with host audio software, see chapter 8, “Working with Host Audio Software” (page 63).



# CHAPTER 5 Hardware Installation

## OVERVIEW

- Thunderbolt audio interface setup ..... 33
- USB or iOS audio interface setup..... 33
- AVB Ethernet audio interface setup ..... 34
- Setup for two interfaces ..... 34
- Setup for three to five interfaces ..... 35
- Setup for a multi-switch network ..... 36
- Setup for multiple interfaces ..... 37
- Setup for web app control ..... 38
- Setup for AVB Ethernet audio interface operation..... 40
- A typical 828es setup ..... 43
- Audio connections ..... 44
- Synchronization ..... 46
- Syncing S/PDIF devices ..... 47
- Syncing optical devices ..... 47
- Syncing word clock devices ..... 48
- Syncing to SMPTE time code (LTC) ..... 48
- Syncing an AVB network..... 49
- Syncing multiple AVB audio interfaces connected to a Mac .. 50

## THUNDERBOLT AUDIO INTERFACE SETUP

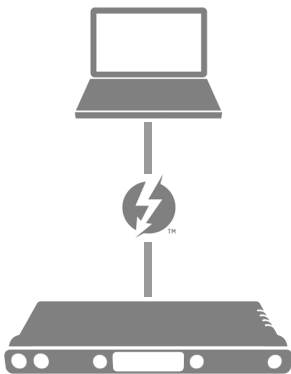

Use this setup if you want to use your MOTU device as an audio interface, and your computer has Thunderbolt™.

- Use a standard Thunderbolt cable (sold separately).

- Place it at the end of the Thunderbolt chain (up to six devices in the chain, not including the computer).
- See chapter 4, “Software Installation” (page 29).
- Use the “Audio interface” preset (page 53).

## USB OR iOS AUDIO INTERFACE SETUP

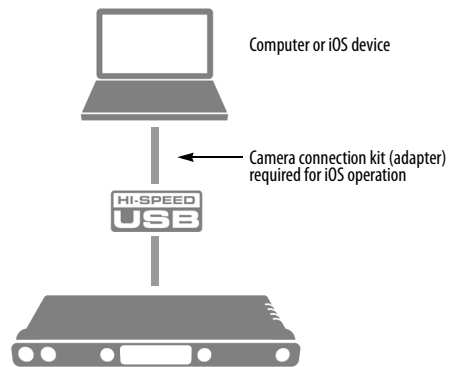

Use this setup if you want to use the 828es as a USB audio interface for a computer or iOS device.

- Use a standard USB cable.
- Connect to any USB port (USB 2.0 or 3.0) on your computer, or use a standard camera connection kit (adapter) for your iOS device.
- See “USB audio class-compliant operation” on page 29.
- For Mac or iOS operation, no driver installation is necessary.
- Use the “Audio interface” preset (page 53).

## AVB ETHERNET AUDIO INTERFACE SETUP

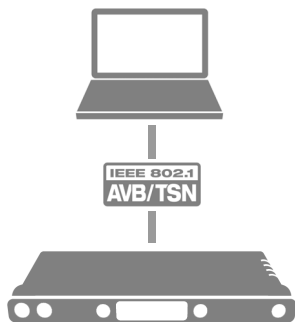

Use this setup if you want to use the 828es as an AVB Ethernet audio interface for a recent-generation Mac (i.e. any Mac with a Thunderbolt port on it). OS X El Capitan (10.11) or later is required for AVB audio I/O.

- Use a standard CAT-5e or CAT-6 cable.
- Connect to the computer's Ethernet port.

See “Setup for AVB Ethernet audio interface operation” on page 40.

### About CAT-5e cables

Use shielded CAT-5e or CAT-6 cables, which are a higher grade version of a standard Ethernet cable. They are available wherever network cables are sold.



## SETUP FOR TWO INTERFACES

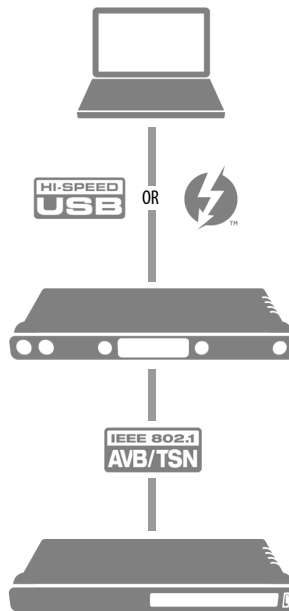

Use this setup if you want to connect two MOTU interfaces to your computer.

- The connection to the computer can be either USB or Thunderbolt, if you have a Thunderbolt-equipped MOTU interface such as the 828es, 8M, 16A, 1248, 112D, 624or 8A.
- Use a standard Thunderbolt cable. Place it at the end of the Thunderbolt chain.
- Use any standard CAT-5e Ethernet network cable to connect the two interfaces together using their NETWORK ports.
- As an alternative, see “Setup for multiple interfaces” on page 37.

## SETUP FOR THREE TO FIVE INTERFACES

Use this setup if you want to connect three to five MOTU interfaces to your computer using a MOTU AVB Switch™ (sold separately).

- The connection to the computer can be USB or Thunderbolt. Use Thunderbolt or USB 3.0, if possible, to support a large number of audio streams to and from the networked interfaces. A single Thunderbolt or USB 3.0 connection supports 128 channels in and out, simultaneously.
- Use standard CAT-5e Ethernet network cables to connect the interfaces to the MOTU AVB Switch using their NETWORK ports.
- Use the five AVB NETWORK ports on the switch (not the Ethernet port).

- Network cable lengths can be long: 100 meters with standard copper wire cables; much longer with fiber-optic network cables.
- See “About CAT-5e cables” on page 34.
- As an alternative, see “Setup for multiple interfaces” on page 37.
- To add more computers to the network, connect them to any interface, as shown. All computers and interfaces have full access to each other.
- See chapter 11, “Networking” (page 95).

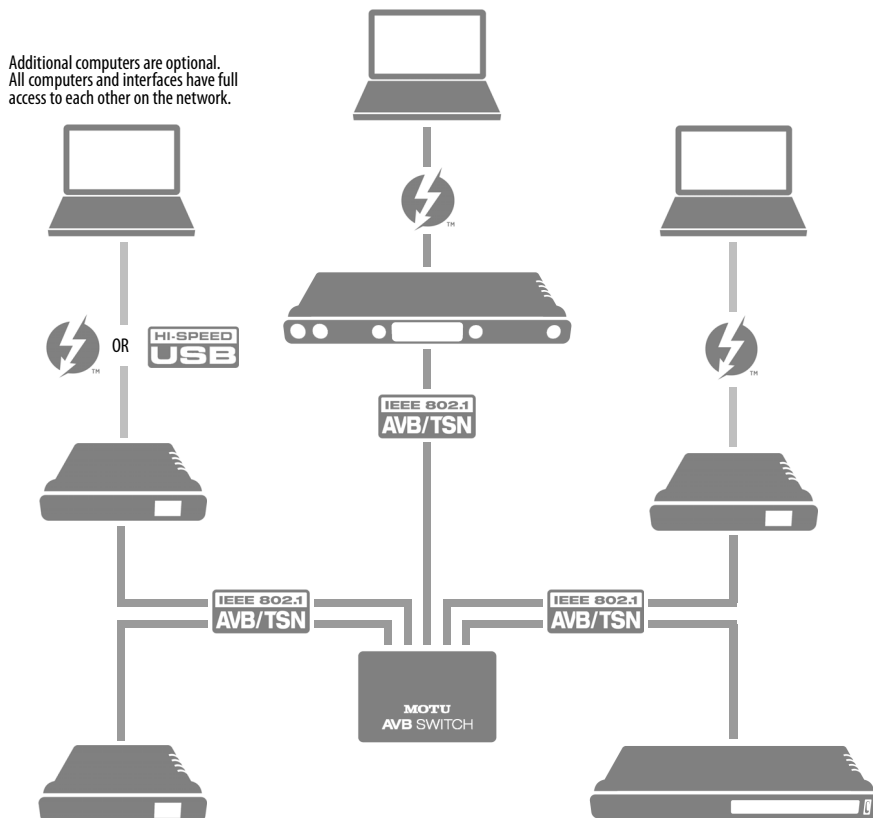

## SETUP FOR A MULTI-SWITCH NETWORK

Use this setup if you want to connect more than five MOTU interfaces to an extended network that employs multiple AVB switches. AVB Ethernet is an industry standard, so you can use MOTU AVB Switches or 3rd-party AVB switches.

- You can daisy-chain switches in serial fashion, but don't create loops. For example, switches A, B, and C below are chained properly, but don't connect C back to A. Alternately, you could connect both Switches B and C to Switch A.
- For further information, see chapter 11, "Networking" (page 95).

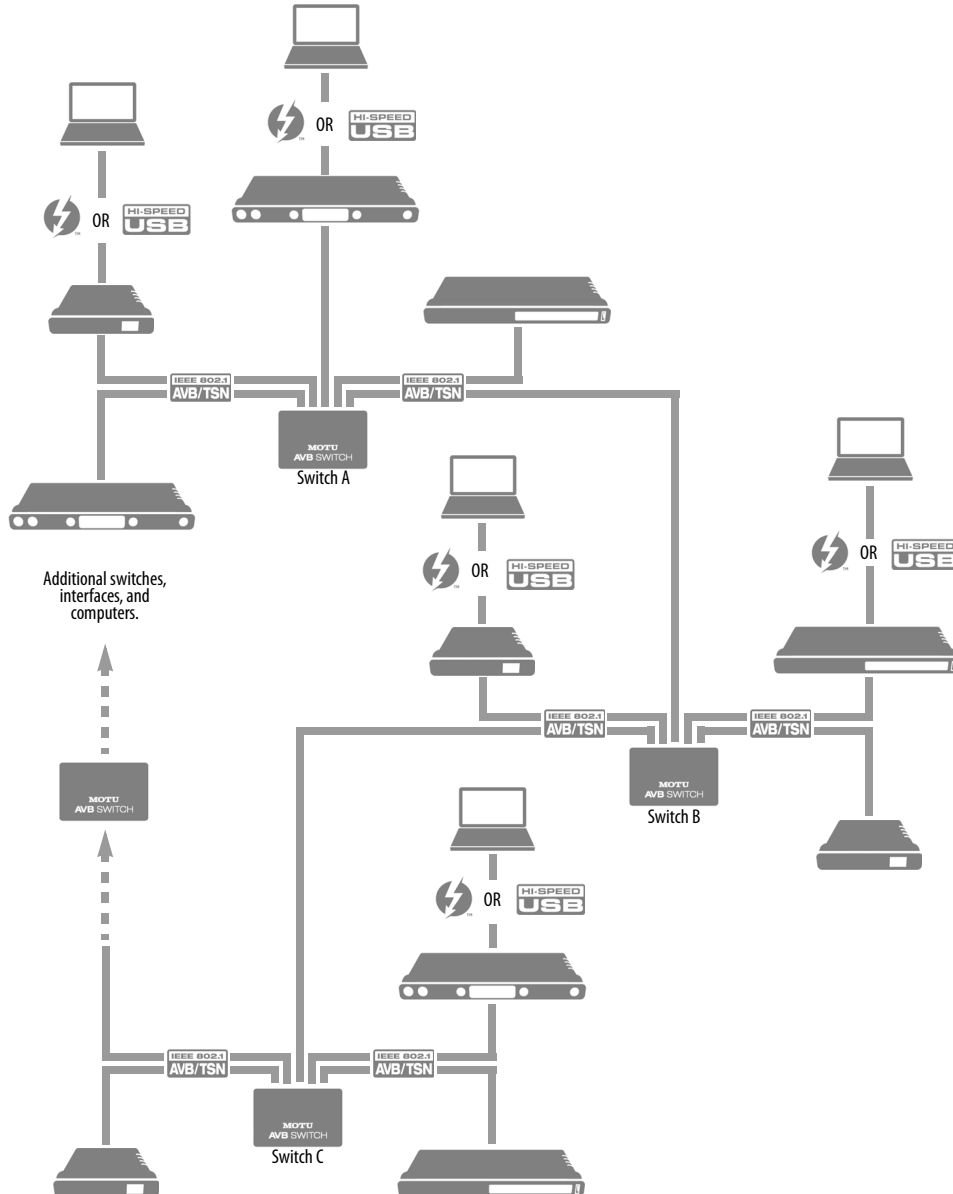



## SETUP FOR MULTIPLE INTERFACES

It is possible to connect multiple MOTU interfaces directly to your host computer through multiple USB (and Thunderbolt) ports. However, there are several disadvantages to using any of these direct connection schemes:

- The audio interfaces will not be clocked to one another and may be susceptible to drift, unless you use external word clock connections (if available). You are better off using the AVB network connections shown on pages 34-36. In this setup, the interfaces are very tightly synchronized with each other (measured in pico seconds) through their network connections.
- You will not be able to route audio directly from one audio interface to another. You are better off using the AVB network connections shown on pages 34-36, which allows you to route audio streams (hundreds at a time) directly among interfaces with near-zero latency.

### Connecting multiple interfaces using Thunderbolt

If you have other MOTU interfaces with Thunderbolt connectivity (1248, 8M, 16A, 112D, 624 or 8A) and your host computer has two or more Thunderbolt ports, you can connect one interface to each port, either directly or at the end of a Thunderbolt daisy chain (on either port or both ports).

### Connecting multiple interfaces using Thunderbolt and USB

Another way to operate multiple interfaces on the same host computer is to connect the first interface to a Thunderbolt port and the second to a USB 2.0 (or 3.0) port.

### Multiple interfaces and USB

When connected through USB, the 828es operates as a USB 2.0 device, even when connected to a USB 3.0 port. USB 2.0 provides enough bus speed for several USB 2.0 devices, but due to the high-

performance requirements of the 828es for real-time operation and low latency timing, we recommend the following:

- Do not connect more than two units to your computer's USB 2.0 (or 3.0) ports.
- When two units are connected with USB 2.0, don't connect other USB 2.0 or 3.0 devices, such as external hard drives.
- For best results, establish clock synchronization with other interfaces connected to the same computer. You can use word clock, S/PDIF, optical or AVB to achieve clock synchronization.

### Multiple AVB Ethernet audio interfaces

When operating 828es as an AVB Ethernet audio interface ("AVB Ethernet audio interface setup" on page 34), multiple AVB audio interfaces can be connected using a MOTU AVB Switch (or any 3rd-party AVB switch), and the Mac can see all of them through their AVB connection. For example, you could connect an Avid S3 console to the Mac, and then connect a MOTU 828es to the S3's extra network port (which is a built-in switch). The Mac can see both 828es and S3 for audio I/O. For best results in this scenario, be sure to use OS X 10.11 (El Capitan) or later. See "Syncing multiple AVB audio interfaces connected to a Mac" on page 50.

### Mixing and matching audio interfaces

You can mix and match MOTU audio interfaces. For example, you could connect an 828es through Thunderbolt and another MOTU audio interface, such as the Stage-B16, through USB 2.0.

## SETUP FOR WEB APP CONTROL

The MOTU Pro Audio Control web app gives you access to all settings, routing, mixing, and effects processing in the 828es, and each interface on the AVB network, if applicable. For more info, see “MOTU Pro Audio Control Web App” on page 11.

The web app is a web application served by the hardware. All you need to run it is a web browser running on a device that has a connection to your audio interface through Thunderbolt, USB or a shared network.

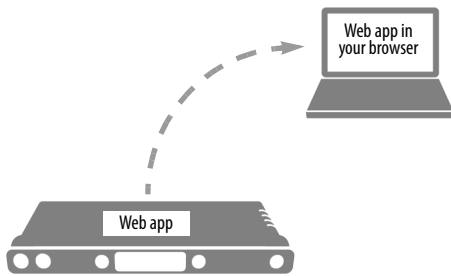

Figure 5-1: The web app is served from the hardware, and accessed through any web browser on any device connected to the interface.

### Web app control can be set up independently of audio connections

The connections in this section, especially the network scenarios, can be set up independently of Thunderbolt, USB or AVB networking connections you make for audio routing (as shown in the setup diagrams earlier in this chapter). In addition, connections for web app control can be made over standard Ethernet and do not require AVB Ethernet connections. Think of web app control as being separate from audio. Doing so opens up a lot of possibilities for control of the 828es, independent of the connections you make for audio.

### Mixing and matching web app control scenarios

The web app connection scenarios shown in the following sections are not exclusive from one another. You can set up as many web app connections as you wish and control your MOTU device from many web app hosts simultaneously.

### Launching the web app

Once you’ve made any of the connections shown in the following sections, launch the web app as explained in “Make hardware and network connections” on page 11.

### Web app control over Thunderbolt or USB

If the 828es is connected through Thunderbolt or USB to a computer with internet access (as shown on page 33), you can access the web app from the computer, or any other device on the network. In this case, make sure you’ve run the software installer (page 29), which installs drivers that allow your computer to properly communicate with the device.

### Web app control through standard Ethernet

The 828es can also be controlled by the web app running on any device that has a standard Ethernet connection to the interface, either directly with a network cable, through an Ethernet hub, or through Wi-Fi on your local network. The sections on the opposite page show you how to set up each of these connection scenarios.

### Ethernet cable

A simple Ethernet cable connection can be used for web app control, even without a USB or Thunderbolt connection to your computer. For example, if you are using your MOTU device as a mixer or audio router, you could control the on-board routing, mixing and effects from the web app through a standard Ethernet connection.

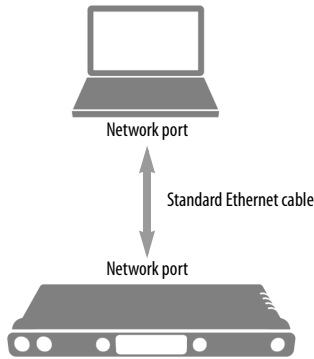

Figure 5-2: Web app control through a simple Ethernet cable.

### Ethernet hub or network (LAN)

In this scenario, both your laptop and your MOTU device are connected to a standard Ethernet hub or home/office network (LAN). You can run the web app on multiple computers simultaneously.

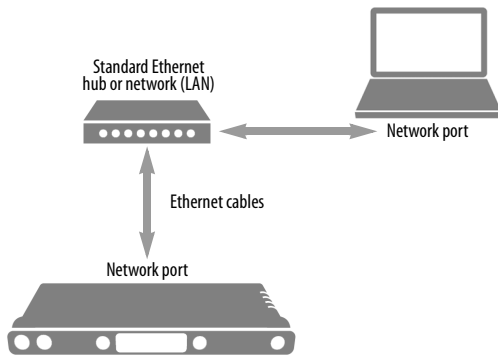

Figure 5-3: Web app control through a standard Ethernet hub or network (LAN).

### Wi-Fi

When using standard Wi-Fi as shown, you can control the 828es from multiple Wi-Fi devices simultaneously.

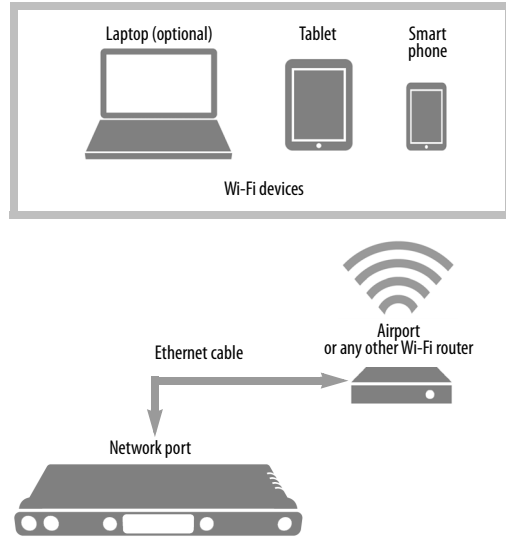

Figure 5-4: Web app control through Wi-Fi.

### Ethernet network + Wi-Fi

You can, of course, combine the setups shown in Figure 5-3 and Figure 5-4, with Wi-Fi connected to the Ethernet hub or network.

### MOTU AVB Switch

The MOTU AVB Switch provides five AVB Ethernet ports, plus one standard Ethernet port. Use the AVB ports for MOTU audio interfaces, and use the Ethernet port for Wi-Fi, Ethernet, etc.

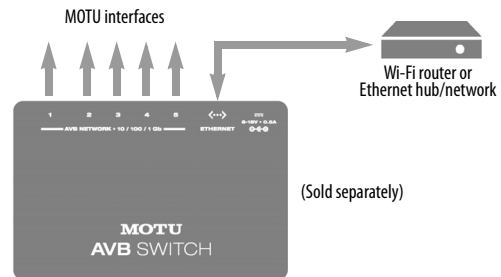

Figure 5-5: Using the Ethernet port on the MOTU AVB Switch.

## SETUP FOR AVB ETHERNET AUDIO INTERFACE OPERATION

Your MOTU hardware can serve as an Ethernet audio interface when connected to a recent generation AVB-equipped Mac. You can then use your MOTU interface as a standard multi-channel audio interface with any Core Audio compatible host software running on the Mac.

For Ethernet audio interface operation, you need:

- A recent Mac (any Mac that has a Thunderbolt port on it)
- OS X El Capitan (10.11) or later
- Firmware version 1.2.5 or later in your MOTU interface

### Ethernet connection to the Mac

As shown on page 34, connect the network port on your MOTU interface to the Ethernet port on the Mac using a standard, high-grade (CAT-5e or CAT-6) network cable up to 100 meters in length.

☛ If your Mac doesn't have an Ethernet port, you can connect your MOTU interface via Ethernet using a Thunderbolt-to-Ethernet adapter. Ethernet might be preferable over Thunderbolt because the Ethernet cable can be up to 100 meters long, using standard Ethernet cabling (which is very affordable).

☛ USB-to-Ethernet adapters cannot be used because the Mac's USB chip set does not support AVB Ethernet.

Alternately, you can connect both the Mac and the interface to an AVB-compatible Ethernet switch.

### Web app setup

To set up your MOTU device as an AVB Ethernet audio interface:

**1** Launch the MOTU Discovery app. From the Settings menu (circled in red below), choose *Launch Mac Virtual Entity*, and from the sub-menu choose the Ethernet port to which your MOTU interface is connected. It should now be checked.

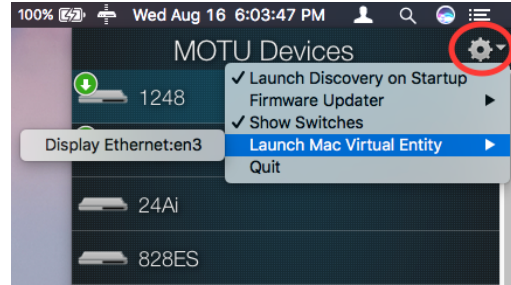

Figure 5-6: Enabling AVB connectivity to the Mac.

**2** After completing step #1 above, the Mac will appear in the AVB device list in the MOTU Pro Audio Control web app, as shown below. PLEASE NOTE: it may take several minutes for the Mac to appear in the list, the first time you set this up. After the first time, though, you won't experience any delays.

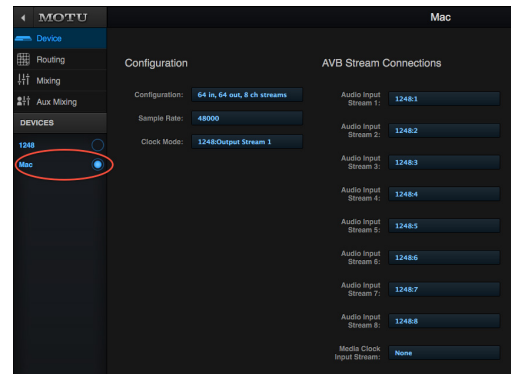

Figure 5-7: Accessing the AVB settings for the Mac in the MOTU web app.

**3** From the Configuration menu (Figure 5-7), choose the channel mode for the Mac that best fits your workflow.

MOTU interfaces currently only support 8-channel streams (or less) so be sure to avoid configurations with streams that have more than eight channels.

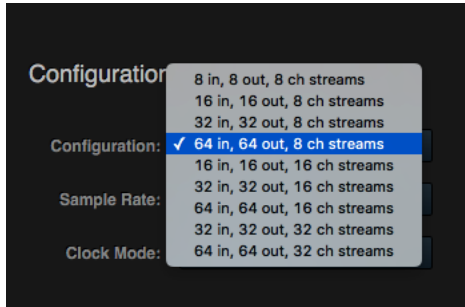

Figure 5-8: Choosing an AVB configuration for the Mac.

**4** From the *Sample Rate* menu (Figure 5-7), choose the desired sample rate. Currently, the Mac only supports 48, 96 and 192 kHz sample rates.

**5** For Playback from the Mac, go to the *Device* tab for your MOTU interface (the 1248 in the example below), and connect the input streams to the Mac's output streams.

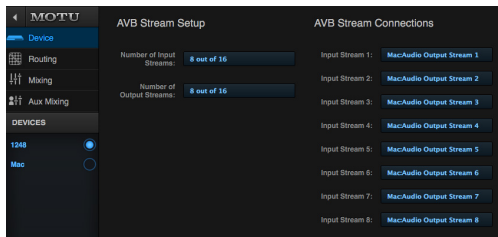

Figure 5-9: Routing computer streams to the interface for playback from the Mac.

**6** In the *Routing* tab, route the Mac's output streams to desired physical outputs on your MOTU interface.

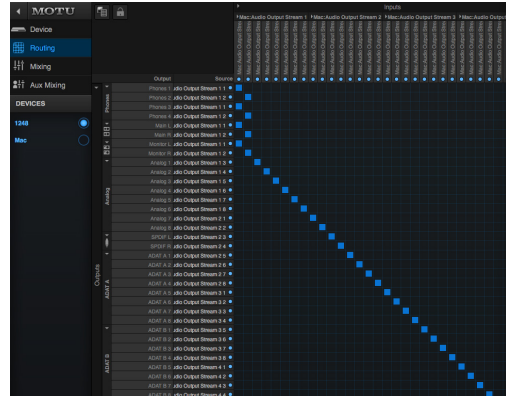

Figure 5-10: Routing Mac channels to physical outputs.

**7** For Recording to the Mac, route desired physical inputs on your MOTU interface to output streams.

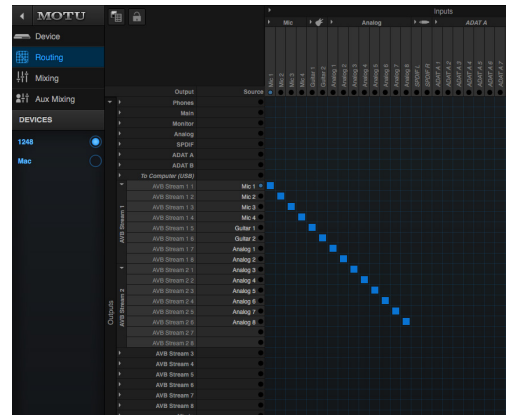

Figure 5-11: Routing physical inputs to the Mac.

**8** On the Mac's *Device* tab, connect the Mac's input streams to the MOTU interface's output streams.

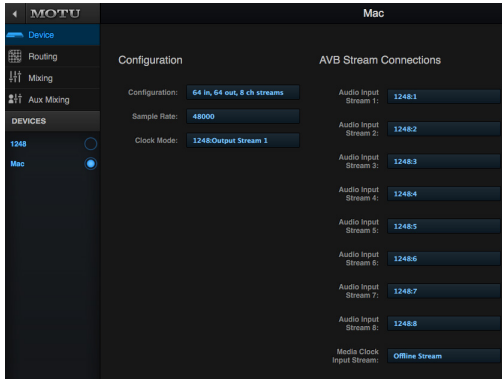

Figure 5-12: Routing streams from your MOTU interface to the Mac.

☛ Leave *Media Clock Input Stream* set to *None*. (This setting can be used to sync the Mac to certain 3rd-party AVB devices that support Media Clock. This setting is not needed for MOTU devices.)

### Clocking

In the example in Figure 5-12, the 1248 is the clock master and the Mac is clocking to the 1248's Output Stream 1. You can also reverse this scenario, where the Mac becomes the master and the 1248 clocks to Mac's Output Stream 1. The Mac does not follow the web app's *Become Clock Master* button, so you must set the Mac's Clock Mode manually.

### AVB stream and channel counts

Each AVB stream is a group of eight audio channels. While testing is on-going, OS X AVB performance varies with different Mac models. Models such as the Mac Pro (late 2013) are able to handle eight streams (64 channels) in and out simultaneously, for MOTU interface models that support eight streams. (Check [motu.com/proaudio](http://motu.com/proaudio) for a summary of supported stream counts for each MOTU interface model.) For older Macs, we recommend one or two streams in each direction. Generally speaking, it is best to enable only as many streams as you need.

## A TYPICAL 828ES SETUP

Here is a typical 828es setup. This rig can be operated with or without a separate mixer. All mixing and effects processing can be done in the

828es itself, controlled from your laptop, tablet, and smart phone — or several devices simultaneously.

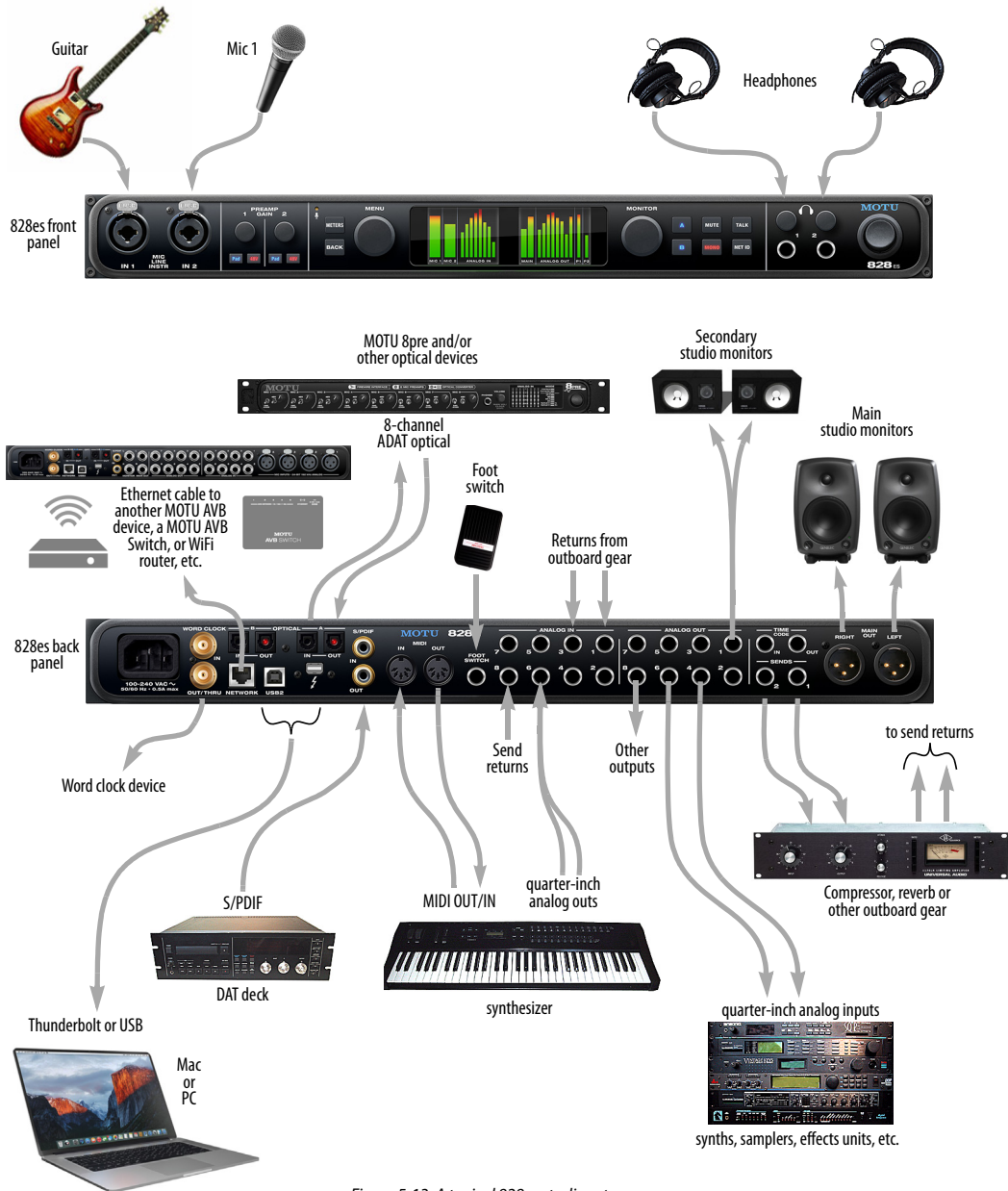

Figure 5-13: A typical 828es studio setup.

## AUDIO CONNECTIONS

Here are a few things to keep in mind as you are making audio connections to your 828es interface.

### Mic/line/instrument inputs with preamps

Connect a microphone, guitar or line-level analog input to the front panel XLR/quarter-inch combo jack with either a standard mic cable or a balanced cable with a quarter-inch plug.

☛ Do not connect a +4 (line level) XLR cable to the front-panel inputs (because of the preamps). Use a quarter-inch input instead.

### Phantom power

If you are connecting a condenser microphone or another device that requires phantom power, engage the corresponding front-panel phantom power switch.

### Preamp gain

The 828es preamps provides 63 dB of gain. Use the front panel detented trim knobs to adjust gain as needed for each input. The LCD provides visual feedback as you turn the trim knob. Preamp gain is digitally controlled, so you can make fine-tuned adjustments in 1 dB increments. You can also adjust preamp gain in the web app. See “Device tab” on page 12.

### -20 dB pad

Each mic input (XLR jack) is equipped with a -20 dB pad switch, to accommodate input signals that could overdrive the input.

### Combo jack summary

Use these guidelines for 48V phantom power, pad and trim settings on the two combo input jacks:

Input	48V	Pad	Trim
Condenser mic	On	As needed	As needed
Dynamic mic	Off	As needed	As needed
Guitar	Off	n/a	As needed
-10 dB Line level via TRS	Off	n/a	As needed
-10 dB Line level via XLR	Off	-20 dB	+12dB
+4 dB line level (TRS only)	Off	-20 dB	Zero

### TRS quarter-inch analog inputs and outputs

Quarter-inch analog inputs and outputs are balanced (TRS) connectors that can also accept an unbalanced plug. The outputs are DC-coupled, so they can be used for CV control output.

☛ Quarter-inch analog outputs are not cross-coupled. Therefore, when connecting them to an unbalanced input, use a TRS plug with the ring disconnected. Not floating the negative terminal will short it to the sleeve ground and cause distortion.

### Main outs

Like all I/O on the 828es, the XLR main outputs operate as an independent pair (they don't share signal with any other output pair). In a standard studio configuration, the main outs are intended for a pair of primary studio monitors, but they can be used as regular outputs for any purpose. With adjustable converter trim, they support a wide range of industry-standard reference levels. Main out volume is controlled by pressing the A button on the front panel (Figure 5-14) and then adjusting volume with the MONITOR knob.

Figure 5-14: 828es front panel





## Analog trims

All analog inputs and outputs can be trimmed. This allows them to support a variety of standards, including EBU-R68, SMPTE RP-155, +4dBu, -10dBV, 2vRMS, 1vRMS.

The 828es quarter-inch analog inputs are equipped with high-quality, digitally controlled analog trim that provides a range from -96 to +22 dB in 1dB steps.

Quarter-inch outputs can be trimmed in the DAC itself. Range is 24 dB.

The Main Outs and Phones provide full trim range from 0 dB to -∞ (-127).

Trim controls are most easily accessed in the web app. See “Device tab” on page 12. Trim settings can also be accessed in the LCD menu.

## Monitor A-B outputs

From the factory, the XLR Main Outs are assigned as monitor pair A and Analog Outs 1-2 as monitor pair B (Figure 5-15). If you have a secondary pair of studio monitors, connect them to Analog Outs 1-2.

You can change these output assignments as desired in the *A-B Monitor Setup* section in the web app Device tab (item #33 on page 14). For more information, see “Monitor controls” on page 59.

## Optical I/O

Your MOTU audio interface provides two banks of ADAT optical (“lightpipe”) connectors. Each bank provides an input and output connector. Together, they provide 16 channels of ADAT

optical digital I/O at 44.1 or 48 kHz, or 8 channels at 88.2 or 96 kHz. The optical ports are disabled when the interface is operating at a 176.4 or 192 kHz. At the high sample rates (88.2 or 96 kHz), 4-channel SMUX operation supports two modes (item #24 on page 13):

- *Standard* — for 2x optical connection to 3rd-party SMUX-compatible hardware products.
- *Type II (Legacy)* — for 2x optical connection to legacy MOTU products that are equipped with optical ports and support 2x operation.

The optical ports are disabled when the interface is operating at a 176.4 or 192 kHz.

## TOSLink (optical S/PDIF)

Alternately, the optical ports can be configured for stereo TOSLink (optical S/PDIF) in the web app (item #24 on page 13). The optical IN and OUT banks can be configured independently.

## Choosing a clock source for optical connections

When connecting an *optical* device, make sure that its digital audio clock is phase-locked (in sync with) your MOTU interface, as explained in “Synchronization” on page 46 and “Syncing optical devices” on page 47.

## S/PDIF

The 828es provides S/PDIF digital audio input and output on the RCA jacks provided. Be sure to review the digital audio clocking issues, as explained in “Syncing S/PDIF devices” on page 47.

Figure 5-15: 828es back panel



## CONNECT MIDI GEAR

Connect your MIDI device's MIDI IN jack to the 828es MIDI OUT jack (Connection A below). Conversely, connect the MIDI device's MIDI OUT jack to the 828es MIDI IN jack (Connection B).

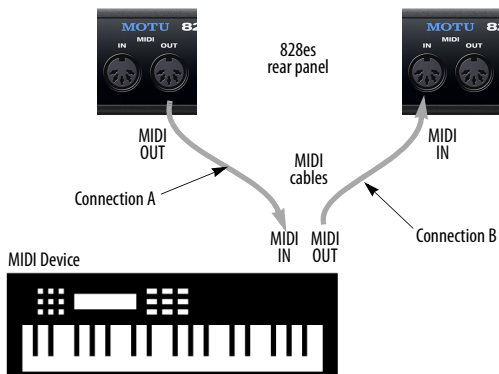

Figure 5-16: Connecting a MIDI device to the 828es.

### One-way MIDI connections

MIDI devices that do not receive MIDI data, such as a dedicated keyboard controller, guitar controller, or drum pad, only need Connection B shown in Figure 5-16. Similarly, devices that never send data, such as a sound module, only need Connection A. Make both connections for any device that needs to both send and receive MIDI data.

### Connecting additional gear with MIDI THRU

If you need to connect several pieces of MIDI gear, run a MIDI cable from the MIDI THRU of a device already connected to the 828es to the MIDI IN on the additional device as shown below in Figure 5-17. The two devices then share the 828es MIDI OUT port. This means that they share the same set of 16 MIDI channels, too, so try to do this with devices that listen to only one MIDI channel (such as effects modules), which makes it easier to avoid MIDI channel conflicts.

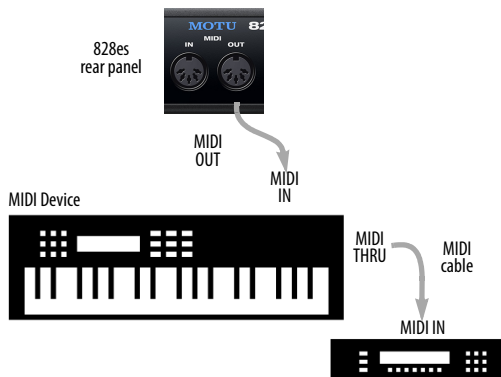

Figure 5-17: Connecting additional devices with MIDI THRU ports.

## CONNECT A FOOT SWITCH

If you would like to use a foot switch with your 828es, connect it to the FOOT SWITCH jack. See item #34 in the Device tab overview (page 14) for information about how to program the foot switch to trigger any computer keystroke you wish.

## SYNCHRONIZATION

If you connect devices digitally to your MOTU device, or if you need to synchronize your MOTU device with an outside time reference such as word clock, you must pay careful attention to the synchronization connections and clock source issues discussed in the next few sections.

### Do you need to sync?

If you will be using only your MOTU device's analog inputs and outputs (and none of its digital I/O), and you don't need to resolve your system to external word clock, you don't need to make any sync connections. You can skip this section.

### Situations that require synchronization

There are two general cases in which you will need to resolve you MOTU device with other devices:

- Synchronizing with other digital audio devices so that their digital audio clocks are *phase-locked* (as shown in Figure 5-18)

- Resolving your MOTU device to an external clock source
- Networking multiple MOTU interfaces together

### Synchronization is critical for clean digital I/O

Synchronization is critical in any audio system, but it is especially important when you are transferring audio between digital audio devices. Your success in using the digital I/O features on your MOTU device depends almost entirely on proper synchronization. The following sections guide you through several recommended scenarios.

### Be sure to choose a digital audio clock master

When you transfer digital audio between two devices, their audio clocks must be in phase with one another — or *phase-locked*. Otherwise, you'll hear clicks, pops, and distortion in the audio — or perhaps no audio at all.

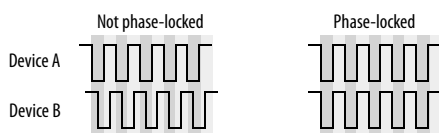

Figure 5-18: When transferring audio, two devices must have phase-locked audio clocks to prevent clicks, pops or other artifacts.

There are two ways to achieve phase lock: slave one device to the other, or slave both devices to a third master clock. If you have three or more digital audio devices, you need to slave them all to a single master audio clock.

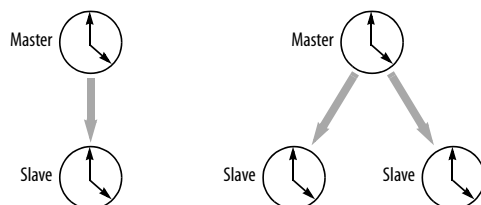

Figure 5-19: To keep the your MOTU interface phase-locked with other digital audio devices connected to it, choose a clock master.

Also remember that audio phase lock can be achieved independently of timecode (location). For example, one device can be the timecode master while another is the audio clock master, but only one device can be the audio clock master. If you set things up with this rule in mind, you'll have trouble-free audio transfers with your MOTU hardware.

### SYNCING S/PDIF DEVICES

The 828es provides RCA S/PDIF digital input and output. Your 828es and the other S/PDIF device will sync to each other by way of the S/PDIF connection itself for click-free digital transfers. One device is the master, and the other device is the slave.

#### Syncing the 828es to its S/PDIF input

When you transfer audio from the S/PDIF device into the 828es, choose S/PDIF as the clock source (item #13 on page 12) to resolve the 828es to its S/PDIF input.

#### Syncing another S/PDIF device to the 828es

When transferring audio from the 828es to another S/PDIF device, set the 828es clock mode (item #13 on page 12) to any source other than S/PDIF. Doing so makes the 828es the clock master. When the other device records (or receives) S/PDIF audio (from the 828es), it will simply synchronize to the clock provided by the 828es S/PDIF signal.

### SYNCING OPTICAL DEVICES

There are several ways to sync an optical device with your MOTU interface:

- Resolve the other device to your MOTU interface
- Resolve your MOTU interface to the other device
- Resolve both devices to a word clock source

For A, choose *Internal* (or anything other than *Optical*) as the clock mode in the Device tab (item #13 on page 12). Then configure the other device to resolve to its optical input.

For B, choose *Optical* as the clock mode (item #13 on page 12), and configure the other device to resolve to its own internal clock.

For C, choose *Word Clock* as the clock mode for the 828es (item #13 on page 12), and resolve the other device to its word clock input.

### Using word clock to resolve optical devices

If the optical device has word clock connectors on it, you can use them to synchronize the device with your MOTU interface. See “Syncing word clock devices” on page 48.

## SYNCING WORD CLOCK DEVICES

The word clock connectors on your MOTU device allow you to synchronize it with a wide variety of other word clock-equipped devices.

For standard word clock sync, you need to choose an audio clock master (as explained in “Be sure to choose a digital audio clock master” on page 47). In the simplest case, you have two devices and one is the word clock master and the other is the slave as shown below in Figure 5-20 and Figure 5-21.



Figure 5-20: Slaving another digital audio device to your MOTU device (an 828es in this example) via word clock. For the 828es clock source, choose any source besides word clock, as it is not advisable to chain word clock.



Figure 5-21: Slaving your MOTU device (an 828es in this example) to word clock. For the 828es clock source, choose 'Word Clock In'.

## Daisy-chaining word clock

If necessary, you can daisy-chain several word clock devices together. When doing so, connect WORD CLOCK OUT from the first (master) device to the WORD CLOCK IN on the second device. Then connect its WORD CLOCK THRU port to the next device’s WORD CLOCK IN port, and so on. On your MOTU interface, use its WORD CLOCK OUT port and change its operation from OUT to THRU in the Device tab of the MOTU Pro Audio Control web app (item #15 on page 12).

If you have more than four word clock devices that you need to synchronize, avoid chaining their word clock connections. Instead, use a word clock distribution device of some kind.

## Word clock is not needed for AVB networking

When working with multiple MOTU interfaces on an AVB network, synchronization is handled by AVB, so no word clock connections are necessary. See the next section for details.

## SYNCING TO SMPTE TIME CODE (LTC)

The Clock Mode menu (item #13 on page 12) provides the ability to resolve to SMPTE time code (*Longitudinal Time Code*, referred to as *LTC*) from any specified analog or digital input.

When you choose the LTC clock mode setting, the audio phase lock engine in your MOTU interface resolves to the incoming time code. (See below for how to specify the time code input.) This ensures that audio passing through the interface remains

resolved to time code and won't drift over time, as long as the audio is coming from other sources that are also resolved to the same time code. This also ensures that audio recorded by DAW host software on a connected computer, or audio playing back from the DAW, will remain resolved to time code and won't drift over time, even when restarting or cuing the source time code.

☛ Depending on the stability of the incoming time code, it may take a few seconds for your interface to lock to the time code. The more stable the incoming time code, the faster the lock-up time.

### SMPTE time code (LTC) settings

There are several settings for the time code features in your MOTU interface. In the web app, go to the Device tab (page 14) and scroll to the LTC Setup section, shown below.

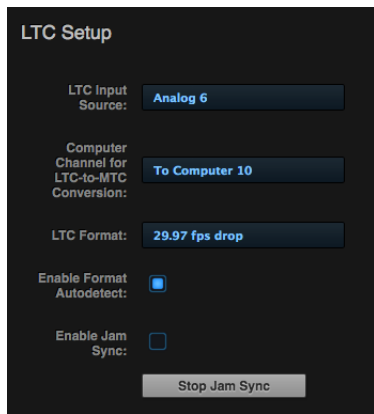

Figure 5-22: Settings for SMPTE time code sync.

### LTC Input Source

Choose the input on your interface that is receiving the time code (LTC). Any input can be used, including an analog input, digital input or even an AVB network channel.

### Computer Channel for LTC-to-MTC Conversion

Choose a computer channel that you aren't using for anything else here. It will be used to transmit LTC from the interface to the computer. If all of your computer channels are being used, you can add extra channels using the *To computer* setting in the Routing tab. See “LTC-to-MTC conversion” on page 69 for further info about LTC-to-MTC conversion.

### LTC Format

Choose the frame format that matches the incoming time code.

### Enable Format Autodetect

If you would like your MOTU interface to automatically detect the frame format of the incoming time code, check this box.

### Enable Jam Sync

When this option is checked, your MOTU interface will continue to convert LTC to MTC even after incoming time code stops being received. Once Jam Sync kicks in, it will continue generating until you click Stop Jam Sync.

## SYNCING AN AVB NETWORK

The AVB protocol provides sophisticated and accurate timing, synchronization, and clocking features for AVB device networks of any size as shown on pages 35-36, including:

- Low latency
- Network-wide time base
- Better-than-sample-accurate phase lock across all connected devices
- Timing accuracy down to the nanosecond

### Choosing a master clock

The web app provides an easy way to choose one device as the master clock for your whole MOTU AVB network.

- 1 Go to the Devices tab (page 12).

2 In the device list (item #1 on page 12), choose the MOTU interface you wish to use as the clock master.

3 Click the *Become Clock Master* button below the Clock Mode menu.

Now, all other MOTU devices on the network are resolved to this device.

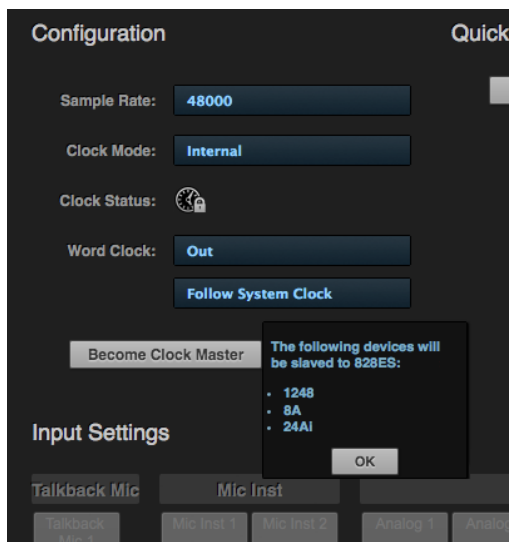

Figure 5-23: Choosing a clock master.

Alternately, you can go to the clock mode menu for each individual device separately and choose the master clock device by hand. For example, you

may be in a situation where at least one MOTU device on the network must remain resolved to its own clock (or another clock source). Just know that in this case, audio cannot be streamed between MOTU devices that don't share the same master clock.

### Resolving the master clock device to an external clock source

The MOTU device you've specified as the AVB network clock master can itself be resolved to an external time base such as word clock (if available) or optical. Just choose the desired clock source from its *Clock Mode* menu (in the Device tab). Doing so effectively resolves the entire AVB network to the external clock source.

### SYNCING MULTIPLE AVB AUDIO INTERFACES CONNECTED TO A MAC

There are several options for clocking multiple AVB audio devices connected to the Mac:

- You can resolve them to an external clock source (like word clock, if available).
- You can create an aggregate device, as usual. The aggregate device setup panel has a check box called *Drift Correction*, which sample-rate converts devices that are not synchronized.

*Part 2*

*Using the 828es*





# CHAPTER 6 Presets

## OVERVIEW

Because of its advanced, extensive feature set, the 828es can be used for many different purposes. This chapter discusses common use cases and their corresponding device presets, to help you use the hardware for your needs.

### Preset menu

The preset menu (item #7 on page 12) contains a number of presets specifically designed for common use cases. By loading the corresponding preset, the 828es routing tab and mixer will be reconfigured accordingly. You can visit the routing and Mixing tabs to inspect settings and adjust them as needed.

Audio interface .....	53
Stand-alone mixer .....	54
Interface + mixer .....	54
Live recording with monitor mixing .....	55
AVB Expansion .....	55
Optical converter .....	56

### Create your own presets

You can create presets to suit your specific needs. The 828es is highly capable and configurable, allowing it to perform many tasks simultaneously.

### Video tutorials

To view several excellent video tutorials for the presets described in this chapter, visit:

[www.motu.com/proaudio](http://www.motu.com/proaudio)

## AUDIO INTERFACE

Choose the *Audio Interface* preset to use your MOTU device as a standard Thunderbolt, USB or iOS audio interface. Hardware inputs and outputs are accessible from your computer or iOS device, and the mixer and audio networking features are disabled.

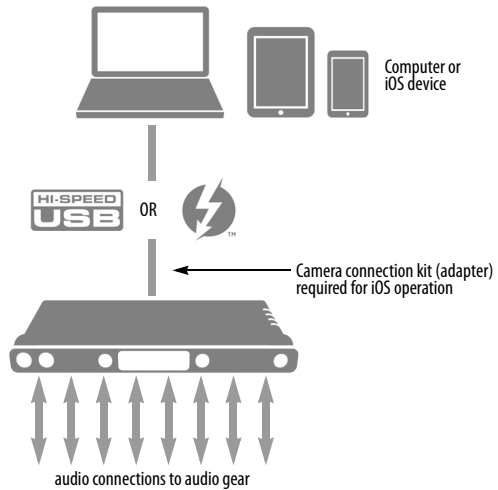

Figure 6-1: Using the 828es as an audio interface.

## STAND-ALONE MIXER

Choose the *Stand-alone* mixer preset to use 828es as a mixer. Doing so routes all physical inputs to the mixer, with the mixer's main mix bus goes to the Main Outs and the monitor bus goes to the Headphone Outs.

To control the mixer (with the web app), you have several options. You can connect a computer to the 828es using Thunderbolt, USB, Ethernet, or Wi-Fi, as explained in "Setup for web app control" on page 38. Figure 6-2 below shows the Wi-Fi scenario. Note that you can control the mix from multiple Wi-Fi devices.

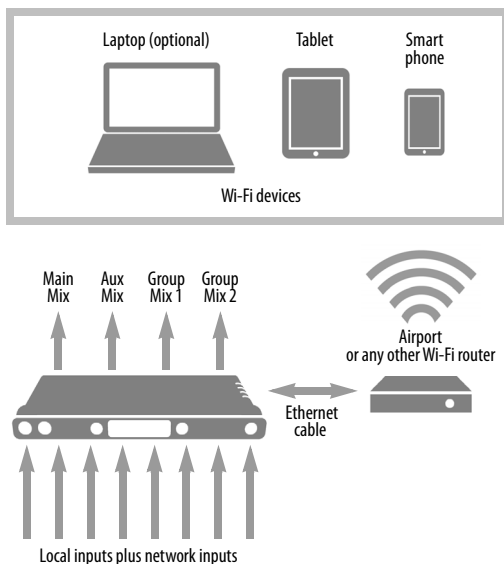

Figure 6-2: Using the 828es as a stand-alone mixer. This example demonstrates how you can control the mixer from several Wi-Fi devices.

## INTERFACE + MIXER

Choose the *Interface + Mixer* preset to use the 828es as both an audio interface and mixer, simultaneously. This preset is identical to the *Audio Interface* preset, except that all *From Computer* channels are also routed to the on-board mixer, which mixes them to the Main Mix bus (to the Main Outs) and the Monitor bus (to the Headphone Outs). The on-board mixer mixes all of the following sources:

- The 828es analog inputs
- The 828es optical inputs
- All *From Computer* channels (Thunderbolt or USB channels from the host computer)

The Monitor bus is set up as a solo bus.

In this scenario, you can control the mixer from the MOTU Pro Audio Control web app running on the computer. You can also run the web app from wireless devices on the same Wi-Fi network as the laptop.

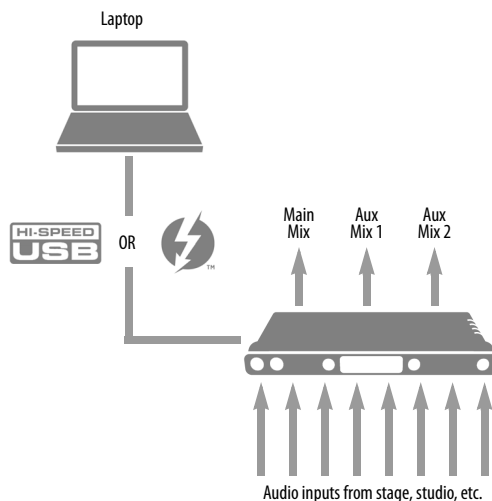

Figure 6-3: Using the 828es as an audio interface and mixer, simultaneously.

## LIVE RECORDING WITH MONITOR MIXING

Choose the *Live recording with monitor mixing* preset when you are tracking in the studio. The setup is pretty much the same as for the “Interface + mixer” preset shown in Figure 6-3 on page 54, except that aux buses are routed to the 828es analog outs (in consecutive pairs) for independent monitor mixes. All physical inputs on the interface are routed to both the computer (for recording) and the Main Mix and Monitor buses in the mixer (for near-zero latency monitoring). Thunderbolt or USB channels from the computer are included in the 828es mix.

## AVB EXPANSION

Use the *AVB Expansion* preset when you want to connect the inputs and outputs on the 828es to other devices over Ethernet cabling. This preset routes all inputs and outputs on the 828es interface to 8-channel AVB network streams in the routing grid, which are then broadcast to any/all other devices on the same AVB Ethernet network.

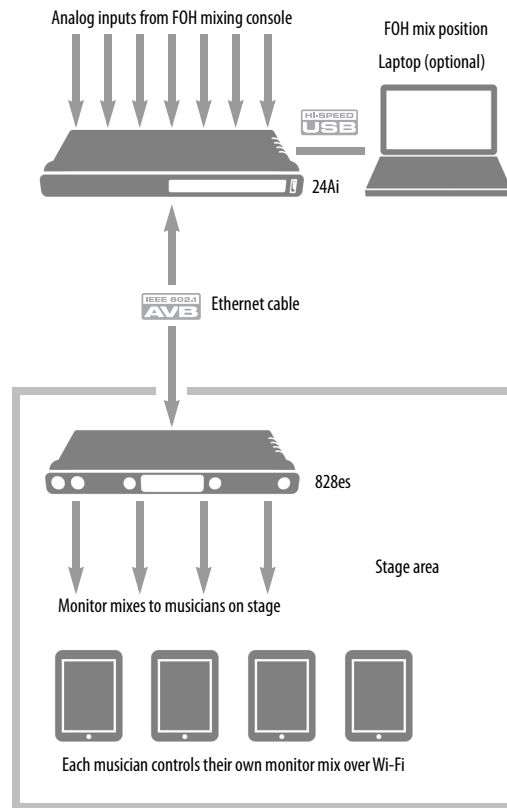
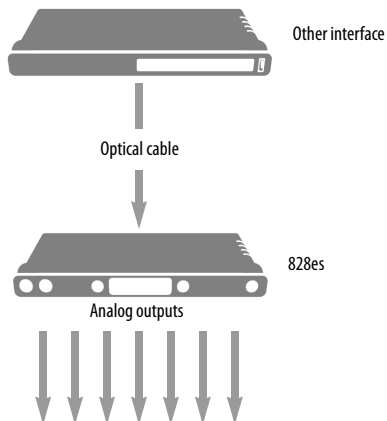

Figure 6-4: An example of using the AVB Expansion preset: 24 channels from the FOH console are being distributed to musicians on stage as 4 separate monitor mixes.

## OPTICAL CONVERTER

Choose the Optical converter preset if you would like the 828es to serve as a multi-channel digital-to-analog or analog-to-digital converter connected to another device equipped with an optical port. This preset sends optical inputs to the 828es analog outputs; conversely, analog inputs are routed to the optical outputs.

For example, if you have another MOTU interface equipped with optical, you could connect its optical output banks to the 828es optical input banks. The 828es then serves as an expander that adds the 828es analog outputs to your setup.



*Figure 6-5: Use the Optical converter preset to use the 828es as an optical-to-analog output expander. You can also use this preset to use the 828es as an analog-to-optical input expander.*

# CHAPTER 7 Front Panel Operation

## OVERVIEW

This chapter explains how to use the features on the 828es front panel, including the two LCD displays, menu navigation, A/B monitor controls and talkback.

- Dual LCD displays.....57
- Three LCD screen sets.....57
- Menu Navigation.....58
- Push-button Knobs.....59
- Channel focus.....59
- Monitor controls.....59
- Talkback.....60
- Net ID.....61
- Headphone volume.....61
- Stand-alone operation.....61

## DUAL LCD DISPLAYS

The two full-color LCD displays on the 828es front panel provide comprehensive metering for all of the analog and digital inputs and outputs. They also display activity indicators for MIDI and network I/O, system settings and menu access to many settings.



Figure 7-1: Push the METERS button to cycle among three LCD screen sets that provide extensive metering, activity indicators and status information.

## THREE LCD SCREEN SETS

Push the METERS button (Figure 7-1) repeatedly to cycle among the three different LCD screen sets shown below.

### Screen set A

Screen set A (Figure 7-2) shows metering and system settings for the sample rate and clock source.

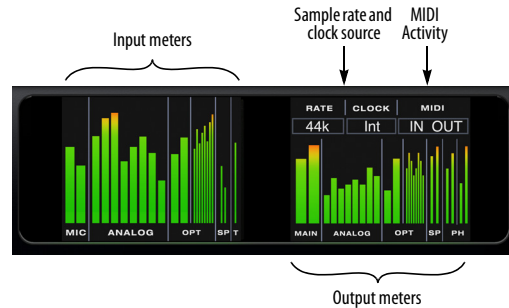

Figure 7-2: Screen set A.

### Screen set B

Screen set B (Figure 7-3) shows analog metering only, without settings.

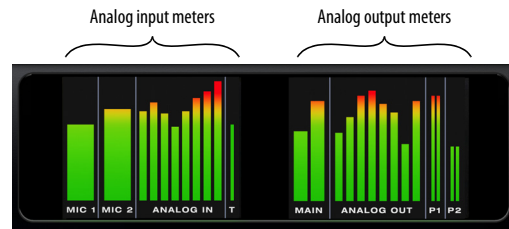

Figure 7-3: Screen set B.

### Screen set C

Screen set C (Figure 7-4) shows metering for all optical and S/PDIF digital I/O, system settings and time code settings.

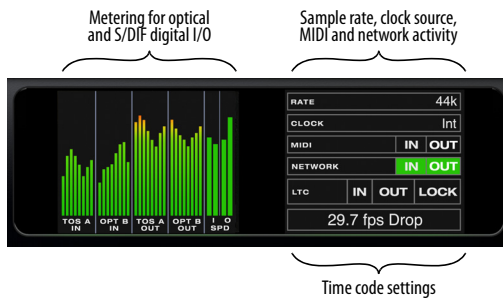

Figure 7-4: Screen set C.

### Sample rate and clock source

The sample rate and clock source section of the LCD (Figure 7-2 on page 57) displays the sample rate at which the unit is currently operating (item #8 in the Devices tab on page 12), and the current Clock Mode setting (item #13 on page 12). The Clock Mode setting can also be found (and changed) in the Settings Menu.

### Time code settings

For more information about the time code settings shown in Figure 7-4 on page 58, see “Syncing to SMPTE time code (LTC)” on page 48.

### MENU NAVIGATION

Push the MENU knob to access the menu, which provides settings and status information (Figure 7-5).

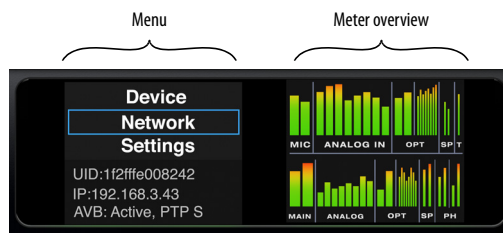

Figure 7-5: Menu navigation.

Turn the MENU knob to scroll through the menu.

Push MENU to enter the selected sub-menu or to select the currently highlighted setting.

A currently selected setting flashes. Turn the MENU knob to change the setting, and push it to confirm the change, or push BACK to cancel the change and exit.

Push BACK to return to the previous menu item.

To exit the menu, push METERS.

### Device

The Device menu item provides information about the device, such as its name and connection mode (Thunderbolt, USB or AVB).

### Network

The Network menu item displays the following network-related information:

Setting	Explanation
Serial/UID	Unique AVB network identifier and serial number that can be used for troubleshooting and registering your device at <a href="http://motu.com/register">motu.com/register</a> .
IP address	The unique network address for the unit. Type this address into your web browser to access the unit's settings in the MOTU Pro Audio Control web app.
AVB	Indicates whether AVB networking is currently enabled or disabled. For example, AVB could be disabled because a non-AVB switch is being used. When AVB is disabled, audio streaming over the network is disabled.

## Settings menu

The Settings menu provides access to basic hardware settings.

Setting	What it does
Clock Mode	Sets the audio clock source for the device.
Sample Rate	Sets the sample rate for the device.
Optical	Specifies ADAT or TOSLink, or the SMUX format when operating at 88.2 or 96 kHz. See “Optical I/O” on page 45.
MIDI Thru	When enabled, MIDI data passes directly from the MIDI input to the MIDI output when the 828es is disconnected from the computer (no USB or Thunderbolt connection to the computer).
Configure IP	Chooses between DHCP and a manually assigned IP Address.
Clear Password	Removes password protection in the web app.
Factory Defaults	Restores factory default settings.

## Presets menu

The Presets menu lets you recall settings that have been saved as a *device preset*. Use the web app to create and save presets (item #7 in the “Device tab” on page 12).

## Version menu

The Version menu item displays firmware version info.

## Meter overview

The meter overview (Figure 7-5) provides metering for all analog and digital I/O.

## PUSH-BUTTON KNOBS

All front-panel knobs are push-button digital rotary encoders. Push the knob view its current setting without changing it (turning the knob).

## CHANNEL FOCUS

When turning a knob to adjust volume or preamp gain, the LCD focuses on the channel with a long-throw, horizontal meter that shows the current setting. A few seconds after you stop turning the knob, the LCD returns to the previous display. To

temporarily suspend the focus timeout, push the knob again while focused. A “pin” icon appears in the LCD to indicate that the focused metering will remain on screen until you push the knob again to dismiss it.

While the display is “pinned” you can adjust any front panel knob and the display will change to the knob you are adjusting. Push any knob to exit channel focus.

## MONITOR CONTROLS

The 828es front panel provides several controls for the primary and secondary monitors in your studio, labeled A and B, respectively (Figure 7-6 on page 59).



Figure 7-6: The front-panel monitor controls.

These controls are also available in the *A-B Monitor Setup* section in the web app Device tab (item #33 on page 14), so you can control them from your laptop, tablet or smartphone.

## Output assignments for Monitor A and B

From the factory, monitor pair A is assigned to the XLR Main Outs and monitor pair B to Analog Outs 1-2 (Figure 5-15 on page 45). You can change these output assignments as desired in the *A-B Monitor Setup* section in the web app Device tab (item #33 on page 14).

## Monitor A/B select

To select a monitor pair and mute the other pair, press A or B (Figure 7-6). Press both buttons at the same time to hear both sets of monitors simultaneously.

## Monitor volume control

Control the volume of both Monitor A and B pairs with the MONITOR knob (Figure 7-6). This knob controls both pairs. To adjust their volume relative to one another, use their trim controls in the Device tab (item #20 on page 12).

## Mute and Mono

Push MUTE (Figure 7-6) to temporarily silence both Monitor output pairs (A and B). Push MONO (Figure 7-6) to temporarily sum each pair to mono. When summing to mono, the left and right channels are mixed together and the resulting mono audio stream is sent to both outputs of the stereo pair. The resulting mono signal is also attenuated by 3 dB to maintain the same overall loudness of the original stereo image.

## TALKBACK

Talkback allows an engineer in the control room to temporarily dim all audio and talk to musicians during a recording session. Talkback requires a microphone located in the control room, near the engineer. The 828es provides a built-in talkback mic on its front panel (item 3 on page 9).

Alternately, you could use an external microphone connected to a mic input (or a line input when combined with a separate preamp), but the built-in mic frees up inputs for other high-priority sources such as vocal mics, guitars, keyboards, etc.

### Talkback setup

To set up talkback:

- 1 Route the talkback mic to a mixer input, as demonstrated in Figure 7-7. If you are using one of the two front-panel mic inputs for an external talkback mic, route that input to a mixer channel.

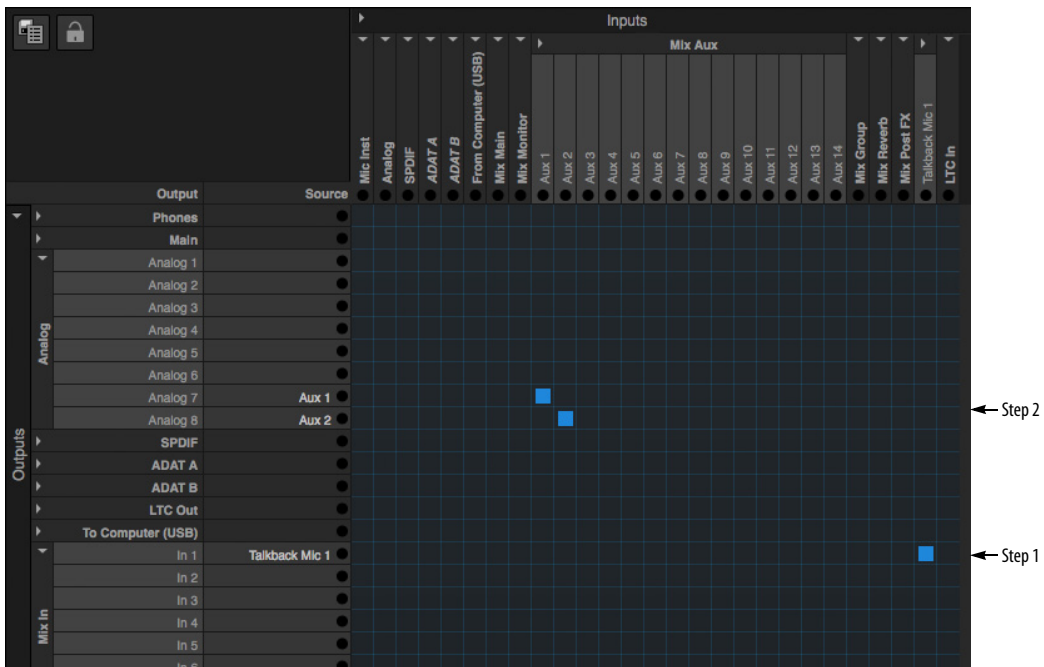

Figure 7-7: Basic routing for the built-in talkback mic. In this example, the built-in talkback mic is routed to input 1 of the mixer. Aux bus 1-2 is assigned to analog outs 7-8, which are being used to route the signal to speakers in the room where the musicians are located.



2 Choose an Aux bus or group for talkback, as demonstrated in Figure 7-7 with *Aux 1-2*, and route it to the outputs feeding speakers (or a headphone mixer) for the musicians.

You can route talkback to as many buses and/or groups as you wish. Route them to whatever physical outputs are needed for your particular setup.

3 In the *Controls* panel of the mixer, show the Legend and the Talkback section (Figure 7-8).

4 For the channel assigned to the talkback mic, enabled its *Talkback source* switch (Figure 7-8).

5 For the aux bus you chose for talkback in step 2, enable its Talkback output switch (Figure 7-8). As mentioned before, you can do so for two or more output buses.

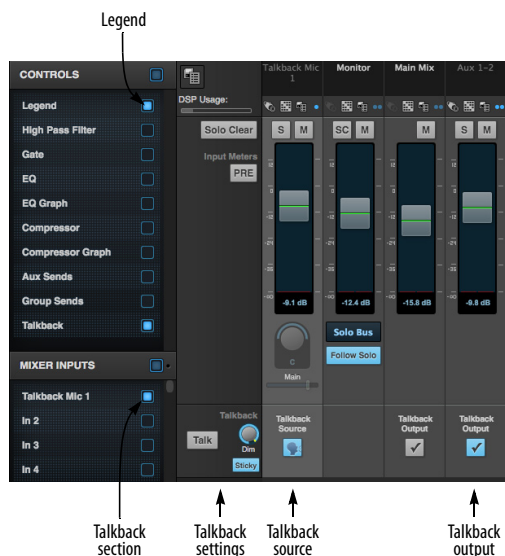

Figure 7-8: Mixer setup for the talkback mic.

### Talkback settings

The talkback settings (Figure 7-8) can be accessed by enabling the Legend in the Controls panel of the mixer.

### Talk

Press and hold the *Talk* button (Figure 7-8) to engage the talkback mic. This is the same as pressing the TALK button on the front panel of the 828es (item #10 on page 9).

### Sticky

When *Sticky* is engaged (Figure 7-8), the Talk button remains engaged when you click it, until you click it again to disengage, so you don't have to hold it down while speaking. This setting also affects the TALK button on the front panel of the 828es (item #10 on page 9).

### Dim

If you are feeding a monitor mix to the musicians on the same Aux bus as your talkback mic, use the *Dim* knob (Figure 7-8) to control how much the monitor mix will be attenuated when talkback is engaged. This gives you control over the relative volume between the talkback mic signal and all other audio on the mix bus. To control overall volume of everything, use the bus fader.

### NET ID

Push NET ID (item #13 on page 9) to immediately view the 828es network information, including its IP Address. Push BACK or METERS to return to the meters.

### HEADPHONE VOLUME

Each headphone jack has independent volume control. The LCD provides visual feedback.

### STAND-ALONE OPERATION

All settings, including mix settings and device settings, are saved in the 828es memory. They remain in effect even when the interface is not connected to a computer. This allows you to use the 828es as a stand-alone mixer. You can make adjustments to any setting at any time from the web app running on a device that has a network connection to the 828es, as explained in "Setup for web app control" on page 38.



# CHAPTER 8 Working with Host Audio Software

## OVERVIEW

The 828es provides multi-channel audio input and output for Core Audio compatible audio applications on the Mac and ASIO or Wave compatible applications on Windows, including MOTU’s Digital Performer and AudioDesk, Apple’s Logic Pro and GarageBand, and other third-party software applications such as Ableton Live, Avid Pro Tools, Cockos Reaper, Propellerhead Reason, Steinberg Cubase and Nuendo, Cakewalk SONAR, PreSonus Studio One, Bitwig, and others.

AudioDesk is available as a free download for 828es owners at [motu.com/download](http://motu.com/download). For complete information about all of AudioDesk’s powerful workstation features, refer to the *AudioDesk User Guide.pdf* found in the Help menu of the AudioDesk application.

Digital Performer, MOTU’s state-of-the-art digital audio workstation software, is available separately; for details about upgrading from AudioDesk to Digital Performer, talk to your authorized MOTU dealer or visit [motu.com](http://motu.com).

Preparation .....	63
Run the web app .....	63
Choose the MOTU Pro Audio driver .....	64
Reducing monitoring latency .....	64
Working with the Routing grid .....	67
Working with on-board mixing and effects .....	69
LTC-to-MTC conversion .....	69

## PREPARATION

Install your host audio software first if you haven’t already done so, and complete these chapters before proceeding:

- chapter 4, “Software Installation” (page 29)

- chapter 5, “Hardware Installation” (page 33)

## RUN THE WEB APP

Before you run your host audio software, launch the web app to configure your MOTU hardware.

The web app lets you configure important settings in your audio interface, enable the desired inputs and outputs, and set up audio streams to and from the computer.

## Sample Rate

Choose the desired sample rate for the 828es (item #8 in the Device tab on page 12) and your host audio software. Make sure the sample rates for the hardware and software match. Newly recorded audio will have this sample rate.

## Clock Mode

The *Clock Mode* setting (item #13 in the Device tab on page 12) is important because it determines the master digital audio clock for your system.

If you do not have any digital audio connections to your MOTU device (you are using the analog inputs and outputs only), and you will not be resolving your host software to optical or another external clock source, choose *Internal*.

If you have devices connected to the optical ports, see “Syncing optical devices” on page 47.

If you have devices connected to the S/PDIF ports, see “Syncing S/PDIF devices” on page 47.

If you are slaving your MOTU device and your host software to word clock, follow the directions in “Syncing word clock devices” on page 48.

If you have devices connected to the network port, see “Syncing an AVB network” on page 49.

## Audio Interface preset

Click *Launch Quick Setup* (item #10 in the Device tab on page 12) and choose the *Audio Interface* preset. Your MOTU interface is now set up for operation as an audio interface with any host audio software. For details about customizing the audio routing to and from the computer, see “Working with the Routing grid” on page 67.

## CHOOSE THE MOTU PRO AUDIO DRIVER

Once you’ve made the preparations described so far in this chapter, you’re ready to run your audio software and enable the MOTU Pro Audio driver, which allows your host software to use the 828es as an audio interface.

### For Mac OS X audio software

For audio software running under Mac OS X, go to the menu item or preference where you choose the audio device (Core Audio driver) you wish to use, and then select the 828es by name.

### For Windows audio software

For audio software running under Windows, go to the menu item or preference where you choose the ASIO driver you wish to use, and then choose *MOTU Pro Audio*. If your host audio software doesn’t support ASIO, choose the *MOTU Pro Audio Wave* driver instead.

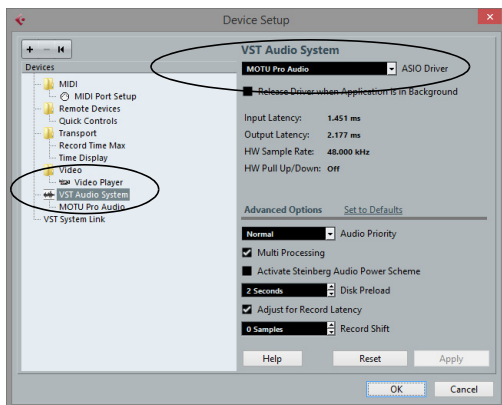

Figure 8-1: Choosing the MOTU Pro Audio ASIO driver in Cubase.

## Where to go in popular audio hosts

Here is the location for this setting in various popular audio software host applications:

Host software	Location for choosing the 828es
Digital Performer and AudioDesk	Setup menu > Configure Audio System > Configure Hardware Driver
Pro Tools 9 or later	Setup menu > Playback Engine or Current Engine
Logic Pro	Preferences > Audio tab > Devices tab > Core Audio tab
Garage Band	Garage Band menu > Preferences > Audio/MIDI > Audio Output/Input menus
Cubase and Nuendo	Device Setup > Devices list > VST Audio System menu
Live	Preferences > Audio tab
Reason	Preferences > Audio preferences
Reaper	Preferences > Audio prefs > Devices

## Other audio software

Consult your software’s manual for further information.

## REDUCING MONITORING LATENCY

*Monitoring latency* is a slight delay caused by running an input signal through your host audio software and back out. For example, you might hear it when you drive a live guitar input signal through an amp modeling plug-in running in your audio sequencer.

This delay is caused by the amount of time it takes for audio to make the entire round trip through your computer, from when it first enters an input on the 828es, passes through the interface hardware into the computer, through your host audio software, and then back out to an output.

### Monitoring through the 828es

If you don't need to process a live input with plug-ins, the easiest way to avoid monitoring latency is to disable your DAW's live monitoring feature and instead use the digital mixer in the 828es to route the input directly to your outputs. For details, see "Mixing tab" on page 16. The mixer in the 828es even provides zero latency effects processing (EQ, compression and reverb), which can be applied to the signal.

### Direct hardware playthrough / Direct ASIO monitoring

When managing your live monitor mix through the 828es mixer, remember to disable your DAW's live monitoring features, so that you won't hear record-enabled tracks in your DAW. Also note that the 828es does not support *Direct Hardware Playthrough* in Digital Performer, or the *Direct ASIO Monitoring* feature (or similar) offered and other DAWs, which lets you control no-latency hardware monitoring from within the host application. Instead, you can use the MOTU Pro Audio Control web app mixer ("Mixing tab" on page 16) to make these live monitoring connections manually.

If you don't require any effects processing on the input signal (no reverb or compression, for example), all this takes is one click in the routing grid to route the input being recorded to the output you are using for monitoring.

If you are recording a mono input that you'd like to monitor in stereo, or if you need to apply effects to the monitored signal, you can simply route the input to the mixer in the 828es. This is done by opening the *Mix In* group in the *Outputs* column along the left side of the grid, and clicking the tile at the intersection of the input's column and the desired mixer input's row. Once routed to the mixer, use the input channel, reverb bus, and monitor bus in the mixer to apply effects as desired, and perhaps include other channels to the

mix, and then assign the monitor bus output in the routing grid to the output you are using for monitoring.

In either case (routing directly in the grid or routing through the mixer), be sure to maintain the input's connection to the computer as well, so the input signal can be recorded in your host software. In other words, you'll want to make sure there are two tiles enabled in the input's column in the grid: one tile for the connection to the computer and another tile for your monitoring output (or a mixer input, if you are using the mixer to apply effects). If you need to route the input signal to other destinations, too, you can certainly do so (you can route the input to multiple destinations).

### Monitoring through your host audio software

If you *do* need to process a live input with host software plug-ins, or if you are playing virtual instruments live through your MOTU audio hardware, you can significantly reduce latency by adjusting the audio buffer setting in your host audio software, as explained in the next section.

☛ It is important to note that monitoring delay has no effect on the recording, or playback, of audio data from disk. The actual recording and playback is extremely precise, it is only the monitoring of your live input signal which may be delayed.

### Adjusting your host software audio buffer

*Buffers* are small bundles of audio data. The 828es "speaks" to your computer in buffers, rather than one sample at a time. The size of these buffers determine how much delay you hear when monitoring live inputs through your audio software: larger buffers produce more delay; smaller buffers produce less.

## Adjusting buffer size on Mac OS X

Under Mac OS X, audio I/O buffer size is handled by the host audio application (not by the 828es Core Audio driver). Most audio software applications provide an adjustable audio buffer setting that lets you control the amount of delay you'll hear when monitoring live inputs or processing them with software plug-ins. Here are a few examples.

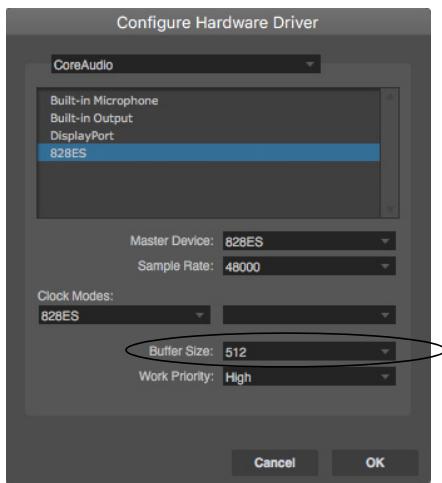

Figure 8-2: In Digital Performer and AudioDesk, choose Setup menu > Configure Audio System > Configure Hardware Driver to open the dialog shown above and access the Buffer Size setting.

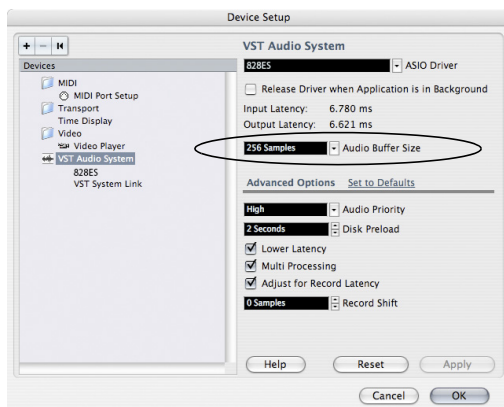

Figure 8-3: In Cubase or Nuendo, choose Devices menu > Device Setup. Select your interface (828es), then click the Control Panel button to access the window above and the Buffer Size setting.

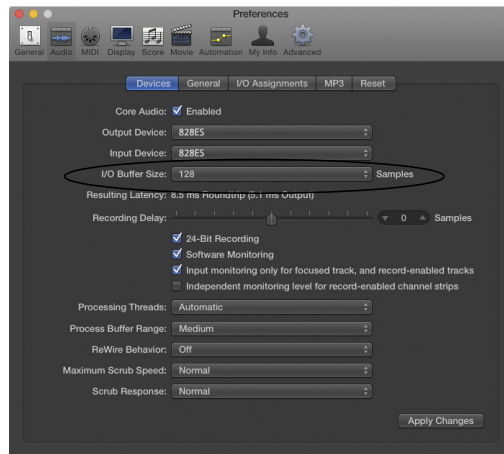

Figure 8-4: In Logic Pro, go to the Audio Driver preferences to access the Buffer Size option shown above.

## Adjusting buffer size on Windows

On Windows, the buffer size is adjusted in the web app Device tab (page 12). See “Host Buffer Size” and “Host Safety Offset” on page 31.

## Lower latency versus higher CPU overhead

Buffer size has a large impact on the following:

- Monitoring latency
- The load on your computer's CPU
- Responsiveness of transport controls and effect knobs in AudioDesk, Digital Performer or other audio software.
- Real-time virtual instrument latency.

The buffer setting presents you with a trade-off between the processing power of your computer and the delay of live audio as it is being patched through your software. If you reduce the size, you reduce monitoring latency, but significantly increase the overall processing load on your computer, leaving less CPU bandwidth for things like real-time effects processing. On the other hand, if you increase the buffer size, you reduce the load on your computer, freeing up bandwidth for effects, mixing and other real-time operations.

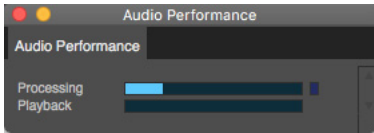

Figure 8-5: When adjusting the buffer size to reduce monitoring latency, watch the 'processor' meter in Digital Performer or AudioDesk's Performance Monitor. If you hear distortion, or if the Performance meter is peaking, try raising the buffer size.

If you are at a point in your recording project where you are not currently working with live, patched-thru material (e.g. you're not recording vocals), or if you have a way of externally processing inputs, choose a higher buffer size. Depending on your computer's CPU speed, you might find that settings in the middle work best (256 to 1024).

### Transport responsiveness

Buffer size also impacts how quickly your audio software will respond when you begin playback, although not by amounts that are very noticeable.

Lowering the buffer size will make your software respond faster; raising the buffer size will make it a little bit slower.

### Effects processing and automated mixing

Reducing latency with the buffer size setting has another benefit: it lets you route live inputs through the real-time effects processing and mix automation of your audio software.

### WORKING WITH THE ROUTING GRID

The Routing grid (Figure 8-6) gives you a lot of control over the audio routing to and from your computer, as explained in the following sections.

### Enabling and disabling input/output banks

In the web app Device tab (page 13), you can enable all input and output banks on your MOTU device that you wish to make available to your host

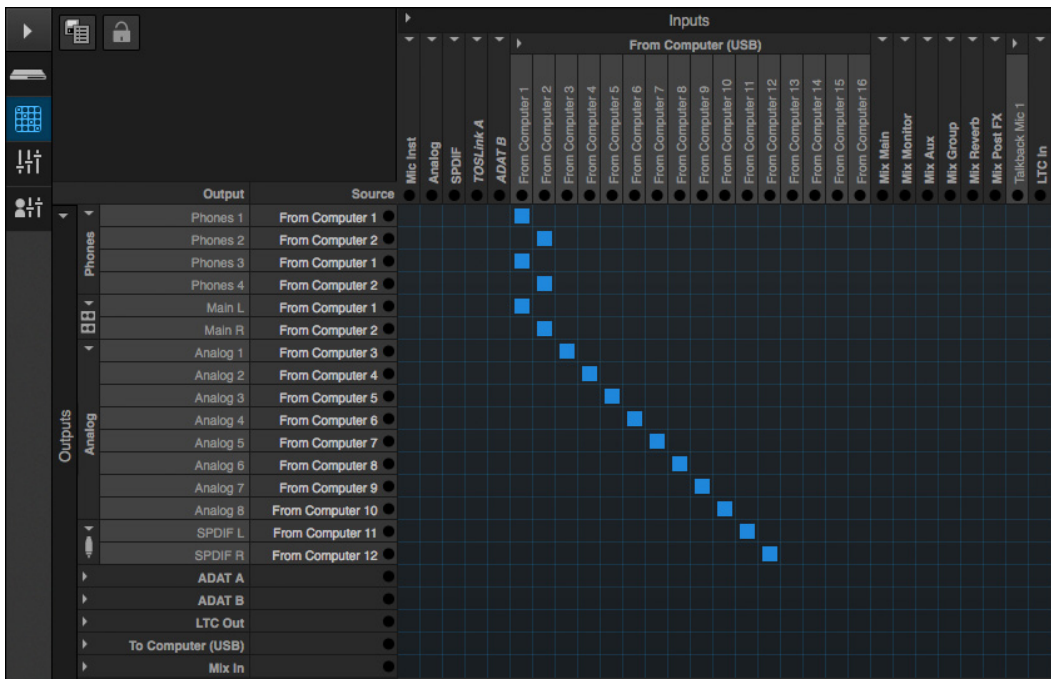

Figure 8-6: An example of routing computer channels (from host audio software) to the analog outputs on an 828es. Computer channels 1-2 are being split to three pairs of outputs: Phones 1-2, Phones 3-4 and Main L-R.

audio software. You can disable banks you are not using to simplify operation. Be sure to keep at least one input and output bank enabled, though.

### Specifying the number of computer channels

In the web app Device tab (item 26 on page 14), in the *Computer Setup* section, you can specify the number of computer channels for streaming audio to and from your host audio software. You might want enough channels to cover the following:

- Physical inputs you want to record on your computer.
- The physical outputs you want to send audio playback to.
- Any audio streams going to and from the on-board mixer in your MOTU device.

- Any audio streams going to and from the AVB network, if you have multiple networked MOTU devices.

If you aren't sure how many channels you'll need, visit the Routing tab, as explained below.

### Making inputs and outputs available to your host software

In the web app, use the Routing tab (page 15) to map inputs and outputs to computer channels, as demonstrated in Figure 8-6 and Figure 8-7.

### Configuration presets

The presets menu (item #7 in the Devices tab on page 12) provides many useful presets for various host routing scenarios. These presets are a convenient shortcut for the routing grid setups discussed in the next few sections.

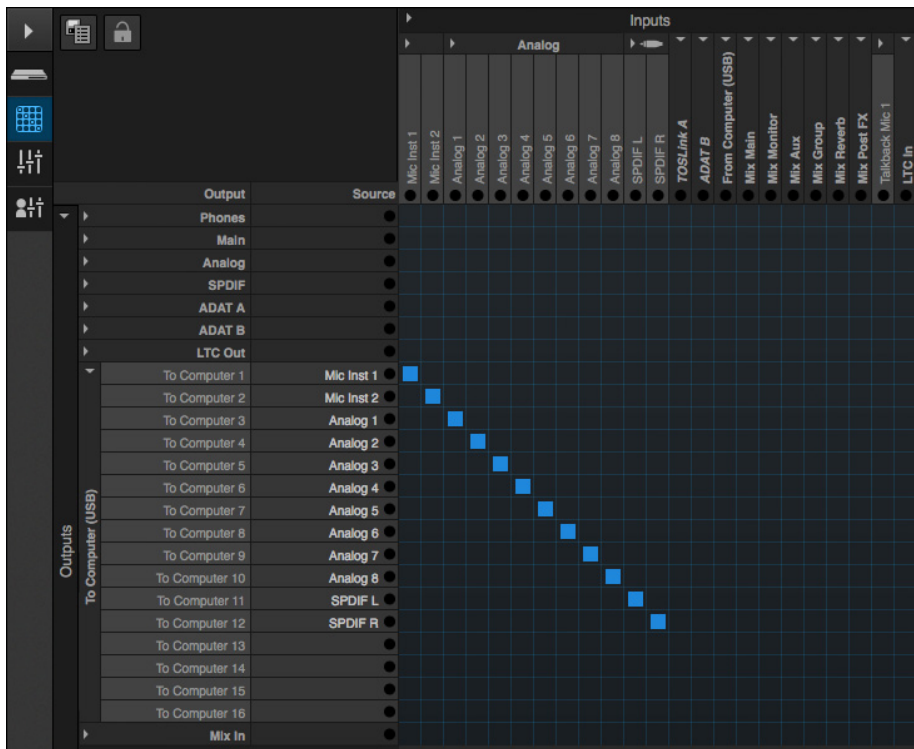

Figure 8-7: An example of routing physical inputs on the 828es to computer channels (for host audio software).



### **Naming computer input and output channels**

Click on any computer input or output name in the routing grid (Figure 8-6) to change its name. These names appear in your host audio software.

### **Streaming computer audio to and from the on-board mixer**

In the Routing grid, you'll see mixer inputs across the top of the grid, including Main, Monitor, Aux, etc. (item 11 on page 15). These are output buses from the 828es on-board mixer. To route one of these mix buses to your host computer software, click the grid at the intersection of the mix column and desired computer channel row. Now, the mix bus output will be routed to the computer via the channel you selected.

Conversely, you can stream audio from the computer into the mixer. Channels coming from the computer are represented across the top of the routing grid as inputs. To route a computer channel to the mixer, click the grid at the intersection of the computer channel column and the desired mix input row. Now, that computer channel will be routed to the mixer input.

### **Working with AVB network streams**

Audio channels going to networked AVB interfaces can be streamed to and from your host audio software through the 828es connected directly to the computer. For information about how to set this up, see "Mapping computer channels to network streams" on page 99.

### **Mirroring computer channels to multiple outputs**

Figure 8-6 shows an example of mirroring one stereo audio stream from host audio software to several outputs. In the example, computer channels 1-2 are being sent to Phones 1-2, Phones 3-4 and Main L-R. To route a source to multiple destinations, click multiple boxes in its column, (see computer channels 1-2 in Figure 8-6).

### **Combining multiple sources to one output**

To merge (mix) any channels in the grid (computer streams or otherwise), route them to mixer inputs and then use the on-board mixer ("Mixing tab" on page 16).

### **Routing grid tutorials**

For further information about using the routing grid, including many useful tips and techniques, visit:

[www.motu.com/techsupport/technotes/avbrouting](http://www.motu.com/techsupport/technotes/avbrouting)

and

[www.motu.com/proaudio](http://www.motu.com/proaudio)

## **WORKING WITH ON-BOARD MIXING AND EFFECTS**

The 828es provides powerful mixing, EQ, compression and reverb, which can operate hand-in-hand with your host's mixing environment. For example, the 828es can serve as a monitor mixer, routing channels to musicians, or it can serve as an integrated extension of your host's mixing environment. You can even save a particular mixing configuration as a preset for future recall. For details, see "Mixing tab" on page 16.

### **LTC-TO-MTC CONVERSION**

When connected to a Mac, your MOTU interface can convert SMPTE time code (LTC) to MIDI Time Code (MTC), allowing any MTC-compatible host audio software to resolve to MTC.

LTC-to-MTC conversion can be done even when the Clock Mode setting for the MOTU interface is set to *Internal* (or any other setting). Note that the Clock Mode setting does NOT have to be set to *LTC*. In other words, the interface can convert LTC to MTC even when it is not resolving its audio engine to the incoming time code. This allows your DAW host software to resolve to time code with fast lockup response.

To set up LTC-to-MTC conversion:

- 1** Set the interface Clock Mode to *Internal* (or any other desired setting).
- 2** Set the other LTC settings as needed, as discussed in “Syncing to SMPTE time code (LTC)” on page 48, including the *Computer Channel for LTC-to-MTC Conversion* setting.
- 3** If you would like MIDI Time Code to continue to be generated, even after LTC stops being received, check *Enable Jam Sync* (Figure 5-22 on page 49). Otherwise, leave it unchecked.
- 4** Follow the directions for MTC (SMPTE) sync in your DAW software.

Your MOTU interface driver automatically communicates with OS X, creating a device in the computer’s Audio MIDI Setup configuration that reports its time code port to any MTC-compatible host software. If your host software requires that you specify the port, you should see your MOTU interface SMPTE Sync port as an available option in the list. In Digital Performer, this is the *Sync to port* menu in the Receive Sync settings (Setup menu), which is set to *Any* by default (so it should just work). Here’s a summary for a few popular DAW hosts:

<b>Host software</b>	<b>Sync settings</b>
Digital Performer and AudioDesk	Settings menu > Receive Sync > Sync to port menu
Pro Tools	Setup > Peripherals > Synchronization
Logic	File > Project Settings > Synchronization > General
Live	Preferences > MIDI Sync
Cubase	Transport > Project Synchronization Setup

# CHAPTER 9 Mixer Effects

## OVERVIEW

This chapter provides further information about the effects processors available in the DSP mixer in the 828es. For basic mixer operation, see:

Mixing tab.....	16
Aux Mixing tab .....	17
Mixer input channel strips .....	18
Main Mix and Monitor channel strips .....	19
Aux bus channel strips.....	20
Group and Reverb channel strips .....	21

## Powerful DSP-driven mixing and effects

The mixer is driven by a powerful DSP that delivers 32-bit floating point precision and plenty of processing bandwidth for no-latency effects, including parametric EQ, dynamics, and reverb. Effects can be applied when operating as an audio interface or as a stand-alone mixer without a computer. Input signals to the computer can be recorded wet and/or dry, or recorded dry while a real-time wet monitor mix is sent to musicians. Effects include:

High Pass Filter .....	71
A conventional high pass filter	
Gate.....	72
A standard gate with threshold/attack/release controls	
Four-band parametric EQ.....	72
Multi-band parametric EQ modeled after British analog consoles	
Compressor .....	73
A standard compressor with threshold/ratio/attack/release/gain controls	

Leveler.....	75
The Leveler™, an accurate model of the legendary LA-2A optical compressor, which provides vintage, musical automatic gain control	

Reverb .....	76
Classic reverb with tail lengths up to 60 seconds	

## Advantages over host-based mixing and processing

The hardware mixer in the 828es provides several major advantages over mixing and processing in your host audio software:

- No buffer latency. The DSP-mixer provides the same near-zero latency throughput performance as a conventional digital mixer. Effects processing doesn't impact your computer's CPU.
- DSP mixing and routing can be maintained independently of individual software applications or projects.
- DSP-driven mixing can function without the computer, allowing the 828es to operate as a portable, stand-alone mixer with effects.
- ☛ Effects are disabled when operating at 4x sample rates (176.4 or 192 kHz).

## HIGH PASS FILTER

All input channel strips provide a 12 dB per octave high pass filter. High Pass filters are often used to remove unwanted mic rumble, for example.

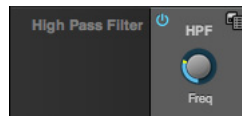

Figure 9-1: The High Pass Filter.

## GATE

All input channel strips provide a Gate module.



Figure 9-2: The Gate module.

The gate silences the signal when the input signal's level drops below the *Threshold*.

The rate at which the gate responds, (opens to let signal through) is determined by the *Attack* parameter. With a short Attack time, the gate will open as soon as the signal crosses the Threshold; with longer Attack times, the gate will gradually open, much like a fade-in.

When the input level falls back below the Threshold, the time it takes for the gate to close (how quickly the signal is attenuated), is determined by the *Release* parameter. Short Release times will close the gate quickly, abruptly attenuating your signal, versus longer release times, which will gradually attenuate your signal, like a natural fade-out.

## FOUR-BAND PARAMETRIC EQ

All mixer channel strips, (except for the Monitor bus), provide modeled, four-band parametric EQ.

### Vintage EQ

Inspired by legendary British large console EQs, the *EQ section* (Figure 9-3) models the sound of the most sought-after classic equalizers. Four bands of center frequency parametric EQ filtering are provided, each with a bandwidth control. The High and Low bands include a shelf filtering option. With 32-bit floating point precision, the vintage EQ has been carefully crafted and meticulously engineered to produce musical results in a wide variety of applications.

## Enabling EQ

Each band has an *enable/disable* button (Figure 9-3), allowing you to enable as few or as many bands as needed for the channel strip.



Figure 9-3: The Four-band parametric EQ module.

## EQ filter controls

The EQ filters have three controls:

Control	unit	range
Gain	dB	-20.00 to +20.00
Frequency	Hertz	20 to 20,000
Bandwidth	Octaves	0.01 to 3.00

Double-click a knob to return to its default position.

## EQ filter characteristics

EQ is one of the most widely used processing tools and can be applied to many different situations, from minor corrective tasks to creative tone sculpting. The four-band EQ has been designed to

be flexible enough to cover a broad range of applications. By adjusting Gain and Bandwidth together, you can emulate the smooth and musical character of classic analog EQ circuits, in which the Gain/Bandwidth dependency was dictated by the actual circuit design and electrical components used.

### Low and high shelf filters

The Low and High bands offer a shelf option that is similar to those found in most conventional parametric EQs.

### EQ graph

The EQ graph below the EQ section (Figure 9-3) provides a thumbnail visual indication of the current EQ settings for the input channel. It is for visual reference only and cannot be edited directly. However, you can click it to open the full-size EQ graph in a separate window (Figure 9-4), which is fully editable.

## COMPRESSOR

All mixer input channel strips provide a compressor module.



Figure 9-5: The Compressor module.

The *Compressor* (Figure 9-5) lowers the level of the input when amplitude of the signal is above the Threshold. The amount of attenuation is determined by the *Ratio* and the input level. For example, if the input is 6 dB above the *Threshold* and the *Ratio* is 3:1, the compressor will attenuate

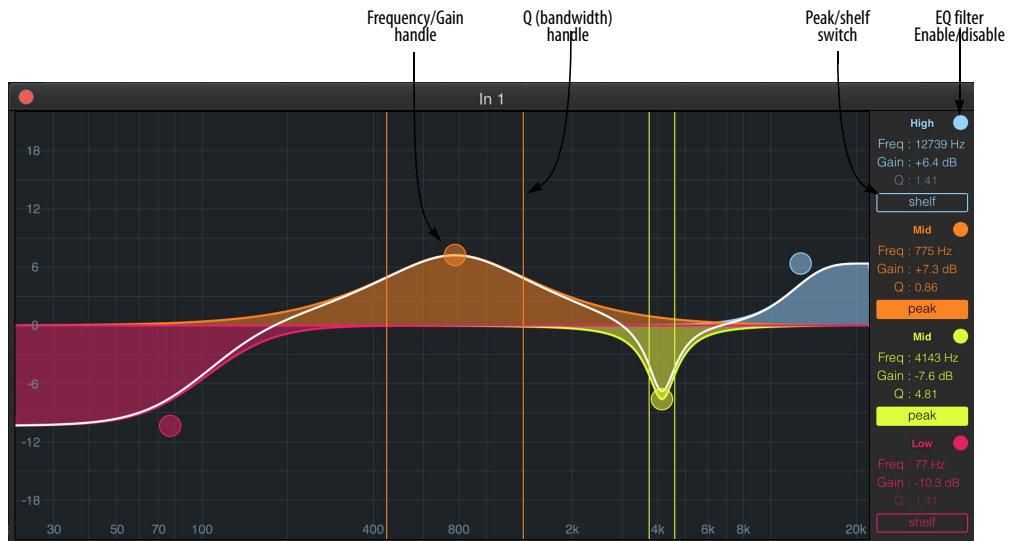

Figure 9-4: The full-size EQ graph.

the signal to 2 dB above the Threshold. When the input level goes above the threshold, the attenuation is added gradually to reduce distortion. The rate at which the attenuation is added is determined by the *Attack* parameter. Likewise, when the input level falls below the Threshold, the attenuation is removed gradually. The rate at which the attenuation is removed is determined by the *Release* parameter. Long Release times may cause the audio to drop out briefly when a soft passage follows a loud passage. Short Release times may cause the attenuation to “pump”, a term used to describe the sound of the compressor when the average input level quickly fluctuates above and below the Threshold. These types of issues can be addressed by adjusting the compressor’s parameters, or applying the Leveler instead. *Gain* adjusts the overall output level of the compressor, post processing. The Level meter (Figure 9-5) shows the level of the input signal entering the compressor. It shows either the Peak envelope or the RMS level, if enabled.

### Gain reduction meter

The Gain reduction meter (Figure 9-5) displays the current amount of attenuation applied by the compressor, before the makeup gain stage.

### RMS mode

By default, the compressor operates in Peak mode, which uses signal peaks to determine the input level. In RMS mode, the compressor measures the input signal’s loudness, using the root-mean-square computational method. When RMS is disabled, RMS mode will let brief peaks through because the detector sidechain is only looking at the average signal level. By contrast, peak mode will catch those brief peaks. Peak mode is generally used for drums, percussion and other source material with strong transients, while RMS mode is mostly used for everything else.

The level meter shows either the peak level or the RMS level, depending on the mode.

### Auto Makeup

When Auto Makeup Gain is engaged (Figure 9-5 and Figure 9-6), the compressor dynamically compensates for any gain reduction, to preserve the original loudness of the signal.

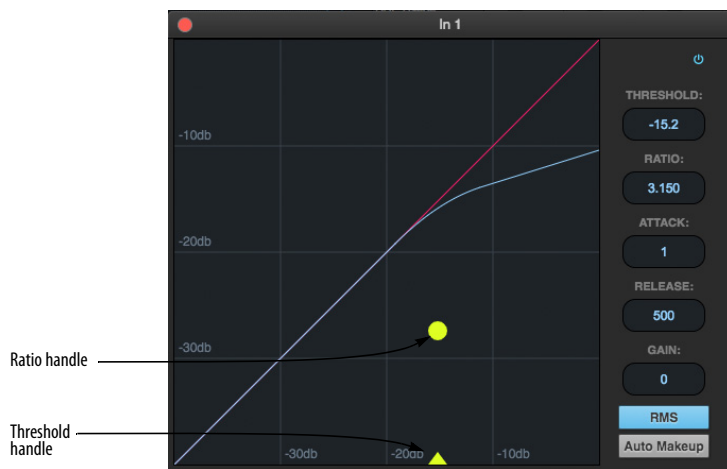

Figure 9-6: The full-size Compressor graph.

## Compressor graph

The Compressor graph below the Compressor section (Figure 9-5) provides a thumbnail visual indication of the current compressor settings for the input channel. It is for visual reference only and cannot be edited directly. However, you can click it to open the full-size Compressor graph in a separate window (Figure 9-6), which provides graphic editing of the Ratio and Threshold controls.

## LEVELER

The Leveler™ (Figure 9-7) provides an accurate model of the legendary Teletronix™ LA-2A® optical compressor, known for its unique and highly sought-after Automatic Gain Control (AGC) characteristics.



Figure 9-7: The Leveler module.

The Leveler is available on the Main Mix bus and all Group busses, including the Reverb bus.

## A model of an optical compressor

An optical leveling amplifier works by shining a light on a photoresistor. The intensity of the light source is proportional to the audio signal, and the resistance of the photoresistor is in turn inversely proportional to the intensity of the light. Photoresistors respond quite quickly to increases in light intensity, yet return to their dark resistance very slowly. Thus, incorporation of the photoresistor into an attenuator followed by an amplifier which provides make-up gain produces a signal which maintains a constant overall loudness.

## Automatic gain control using light

The AGC circuit of the LA-2A uses a vintage optocoupler known by its model number T4. The T4 contains an electroluminescent-panel (ELP) and photoresistor mounted so that the emission of the panel modulates the resistance. An ELP consists of a thin layer of phosphorescent material sandwiched between two insulated electrodes to form a capacitor. Making one of the electrodes transparent allows the light to escape. These devices are essentially glow-in-the-dark paint on a piece of foil covered by metalized glass or plastic, and are the same devices used in low-power night lights. Unfortunately, these devices need high voltages to operate, and are best driven by tube circuits which can supply voltage swings of several hundred volts.

## Response characteristics

Once the light has faded away, the photoresistor then decays back to its dark state. The shape of the decay curve varies depending on how bright the light was, and how long the light lasted. A general rule of thumb is that the louder the program, the slower the release. Typically, the release can take up to and over one minute. One thing to keep in mind when using these types of devices is that the typical concepts of compression ratio, attack, release, and threshold do not apply. The light intensity is determined by the highly non-linear interactions of the input signal, AGC circuit, and ELP, and thus exhibit a strong program dependence that is impossible to describe without the mind-numbing mathematics of statistical mechanics. The actual results, however, can be almost mystical: even when you feed the same material (a loop perhaps) through the Leveler twice, you'll often see a new response the second time through a loop, complete with unique attack times, release times and compression ratios. Furthermore, two different input signals with the same RMS levels may be leveled in a drastically different manner.

It is precisely this self-adjusting behavior that makes optical compressors the tool of choice for smoothing out vocals, bass guitar and full-program mixes without destroying perceived dynamics.

### Enabling or disabling the Leveler

The Leveler models the LA-2A so closely, it also models the time it takes for an actual LA-2A to “warm up” after it is turned on. Therefore, when you enable the Leveler, give it a moment to “settle” before you begin processing signals with it.

### Gain Reduction

*Gain Reduction* (Figure 9-7) sets the strength of the signal sent to the AGC model.

### Makeup Gain

*Makeup gain* (Figure 9-7) amplifies the output signal to make up for gain reduction.

### Limit button

The *Limit* button (Figure 9-7) models the original LA-2A Limit/Compress mode switch. The effect is very subtle, with the Limit option behaving only slightly more like a limiter than a compressor. The switch increases the level of the input to the AGC model and runs the attenuator at a slightly lower level. The Leveler then responds more strongly to transients, but otherwise still behaves like a leveling amplifier.

## REVERB

Use the enable/disable button (Figure 9-8) to turn the reverb processor on or off. Since reverb uses considerable DSP resources, it is best to leave it off when you are not using it.



Figure 9-8: The Reverb processor.

### Routing inputs and groups to the reverb processor

The reverb processor is a single, independent unit that provides stereo reverb. You can route any input channel or Group bus to the Reverb processor with the Reverb send on its channel strip. All incoming signals to the reverb processor are merged and processed together. The resulting stereo output from the reverb can then be merged into the Main Mix bus with the Main send on the Reverb channel strip (item #8 on page 21).

### Reverb Time

*Reverb time* (Figure 9-8) determines the length of decay, or *tail*, of the reverb. The knob’s range is from 100 milliseconds to 60 seconds.

### Predelay

*Predelay* is the amount of time before the acoustic energy from the source returns to the listener, after reflecting off the surfaces of the listening space. The very first reflections helps you perceive information about the listening space, (size, distance, surface type, etc.). In large rooms, it takes a while (on the order of milliseconds) before the



first reflections return to the listener. Predelay is useful for adding clarity, as it delays these reflections, before the onset of full reverberation. For example, with pre-delay added to vocals, the reflections won't start until after the initial sound of a word has been sung.

### **Spread**

*Spread* controls stereo imaging. A position of 12 o'clock produces essentially a mono image. Turning the control all the way to the left completely swaps the stereo image.

### **High and Mid frequency bands**

The High and Mid frequency bands let you independently control the reverb time for separate frequency bands, relative to the low frequency reverb time. The *High* setting represents the bottom frequency of the High band; the *Mid* setting represents the bottom frequency of the Mid band. The *Ratio* determines the length for each band specified in a percentage of the low frequency reverb time.

### **DSP USAGE**

The DSP Usage meter (item #32 on page 18) shows how much of the available DSP processing power is currently being used by the mixer for the mix and for effects processing. If there aren't enough DSP resources for all effects to be enabled on a channel, effects are disabled for that channel and all subsequent channels.

☛ Unlike other effects, HPF and EQ on a stereo channel requires approximately twice the DSP resources as on a mono channel.



# CHAPTER 10 MOTU Audio Tools

The MOTU Audio Tools application provides advanced audio analysis tools, which can be applied to a left channel input, right channel input, or both.

Installation .....	79
Device menu .....	79
Analysis menu .....	80
Left/right input .....	80
FFT and Spectrogram display .....	80
Oscilloscope .....	82
X-Y Plot .....	87
Phase Analysis .....	90

## INSTALLATION

*MOTU Audio Tools* is a standard software application installed on your Mac or PC when you run the MOTU Pro Audio installer or setup app. It can be found in the Applications folder (Mac) or Start menu under MOTU (Windows).

## DEVICE MENU

If you are working with more than one MOTU audio interface, the *Device* menu (Figure 10-1) displays all interfaces that are currently connected to your host computer. Choose the device you wish to work with.

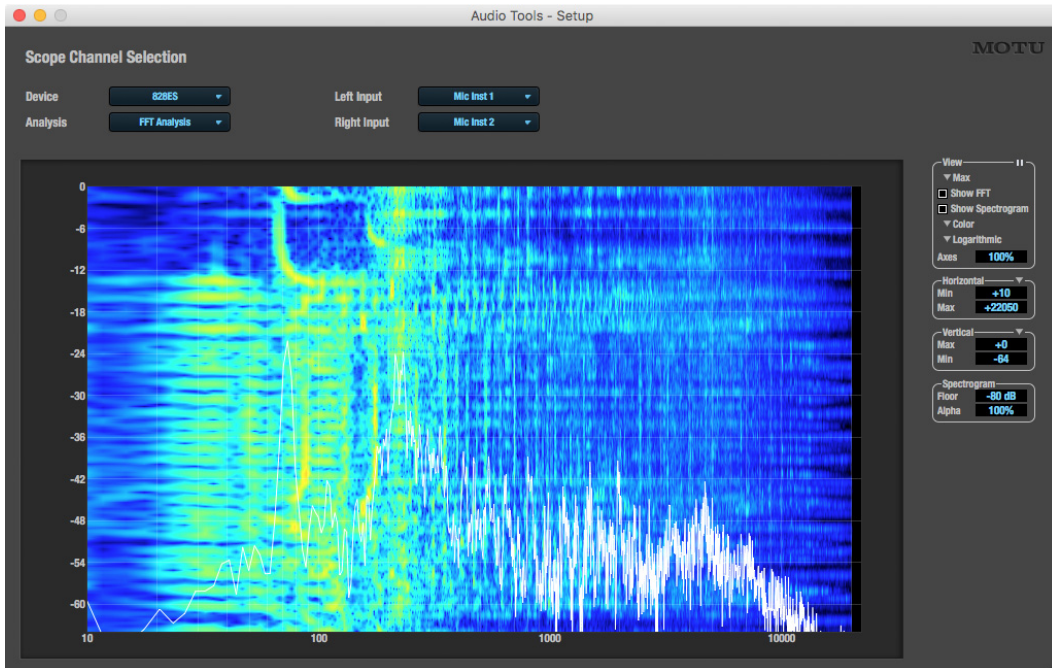

Figure 10-1: The MOTU Audio Tools window with the FFT and Spectrogram Analysis.

## ANALYSIS MENU

Choose the desired form of audio analysis from the *Analysis* menu (Figure 10-1). For details on each analysis pane, see the following sections of this guide.

## LEFT/RIGHT INPUT

Choose the desired channel(s) you wish to scope from the *Left Input* and *Right Input* menus (Figure 10-1). These menus display the *To Computer* channels configured in the MOTU Pro Audio Control web app. The number of channels shown is controlled by the *From device to computer* setting in the Device tab. For example, if 18 channels are specified, you'll see 18 channels in the *Left/Right Input* menus. Use the Routing tab to map desired audio sources (listed across the top of the grid) to the *To Computer* audio channels, as demonstrated in Figure 8-7 on page 68.

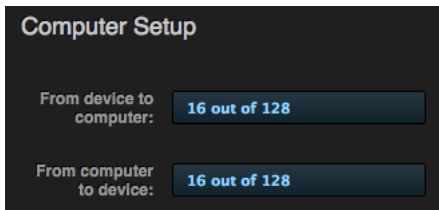

Figure 10-2: The 'From device to computer' setting determines how many channels you see in the Left Input and Right Input menus.

## FFT AND SPECTROGRAM DISPLAY

The FFT analysis pane displays a real-time Fast Fourier Transform (FFT) frequency measurement and spectrogram “waterfall”, as shown in Figure 10-3.

### Spectrogram

The spectrogram scrolls from top to bottom, where the top edge of the display represents what you are hearing “now”. Color represents amplitude along the left/right frequency spectrum. The amplitude color scale runs from black (silence) to red (full scale) as follows:

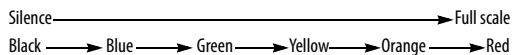

Figure 10-4: Spectrogram color-to-amplitude spectrum.

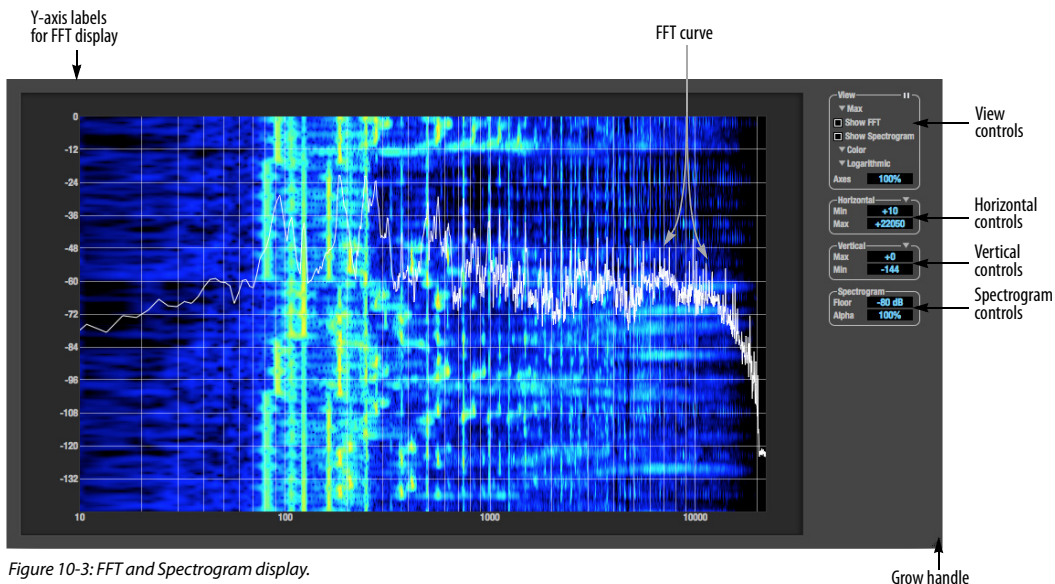

Figure 10-3: FFT and Spectrogram display.

## View controls

You can show and hide the FFT display and spectrogram as desired using the *View* controls (Figure 10-5).

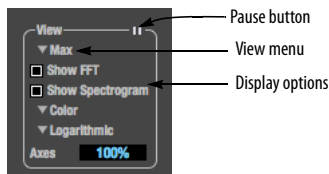

Figure 10-5: FFT view controls.

## View menu

This menu provides various options for displaying the two input channels.

View menu setting	What it does
Left	Displays the left channel only.
Right	Displays the right channel only.
Split Screen H	Shows both channels side by side, with the screen split horizontally.
Split Screen V	Shows both channels side by side, with the screen split vertically.
Shared	Displays both FFTs (left is green and right is red), and the spectrogram waterfall shows the maximum level of either the left or right channel (whichever is greater).
Max	The FFT and spectrogram shows the maximum level of either the left or right channel.
Subtract L - R	Subtracts the right channel from the left channel and displays the results.

## Logarithmic or Linear X-Axis Scale

The x-axis defaults to a logarithmic scale, but it can be changed to a linear scale if desired. In the View controls (Figure 10-5), click *Logarithmic* to access the x-axis scale options menu. With a linear scale selected, frequency is constant, but the width of each octave along the x-axis is different. With a logarithmic scale selected, octaves are displayed with a constant width, but frequency is displayed logarithmically within each octave.

## Axes display

The *Axes* control (Figure 10-5) sets the opacity of the grid displayed in the graph, from 100% (fully visible) down to 0% (fully hidden).

## Pausing the display

The Pause button in the upper right corner of the View section (Figure 10-5) allows you to freeze the display at any time. To resume, click the button again.

## Horizontal controls (frequency axis)

The *Horizontal* controls (Figure 10-6) configure the value range of the x-axis (frequency). Click and drag the values up or down to set them, or double-click to return to the default value.



Figure 10-6: The Horizontal controls.

There are two modes for the controls: *Zoom/Offset* and *Min/Max*. To change the mode, use the Horizontal control menu (Figure 10-6).

In *Zoom/Offset* mode, *Zoom* sets the display zoom from 1x to 100x, where the number represents the zoom factor relative to the entire frequency range. For example, when the horizontal zoom value is 1x, the entire frequency range from 10 to 24000 Hertz is displayed; when the horizontal zoom value is 2x, one half of the entire frequency range is displayed. *Pos* determines which frequency is displayed at the center of the graph.

In *Min/Max* mode, *Min* and *Max* set the lowest and highest displayed frequencies (in Hertz).

## Vertical controls (amplitude axis)

The *Vertical* controls (Figure 10-7) operate similarly to the Horizontal controls, except that they configure the y-axis (amplitude).



Figure 10-7: The Vertical controls.

In *Zoom/Offset* mode, *Zoom* sets the display zoom from 1x to 100x, and *Pos* sets the center amplitude of the graph. In *Min/Max* mode, *Min* and *Max* set the smallest and largest displayed amplitude.

### Spectrogram controls

The *Floor* control (Figure 10-8) sets the amplitude threshold for the spectrogram display, from -144 dB up to 0 dB.

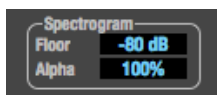

Figure 10-8: The Spectrogram controls.

The *Alpha* control (Figure 10-8) sets the opacity of the spectrogram information displayed in the graph, from 100% (fully visible) to 0% (hidden).

## OSCILLOSCOPE

The Oscilloscope (Figure 10-9) graphs the amplitude of an audio signal over time.

Amplitude is displayed on the y-axis and time is displayed on the x-axis. A thick white vertical line marks where time equals zero; a thick white horizontal line marks where amplitude equals zero (Figure 10-9, below).

Level meters are displayed to the right of the graph. One or two meters are shown, depending on the current view mode (see "View controls").

### View controls

The View controls (Figure 10-10) provide several options for the oscilloscope display.

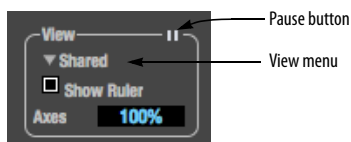

Figure 10-10: View controls.

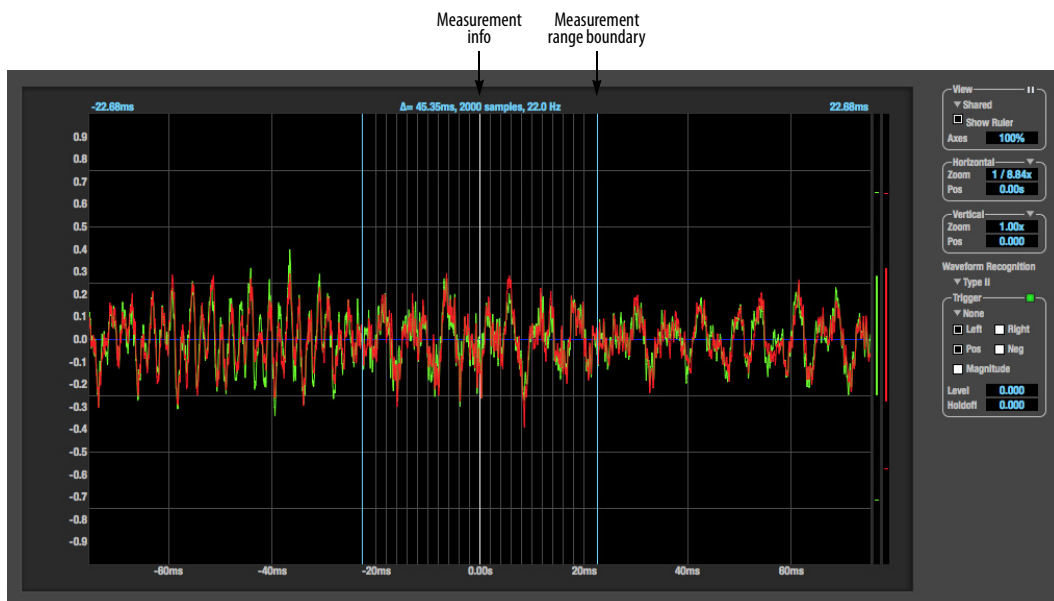

Figure 10-9: Oscilloscope.

## View menu

The View menu (Figure 10-10) lets you choose how to display the audio channel(s) being displayed.

View menu setting	What it displays
Left	Left channel only
Right	Right channel only
Split screen	Left channel on top; right channel on the bottom
Shared	Left and right on top of each other; left is green, right is red
Add	Left and right channels' amplitudes are added together
Subtract L-R	The right channel's amplitude is subtracted from the left channel's amplitude

## Display options

The *Axes* control (Figure 10-10) sets the opacity of the grid displayed in the graph, from 100% (fully visible) down to 0% (fully hidden). The *Show Ruler* option toggles the measurement items (see “Measurement information” on page 85).

## Pausing the display

The Pause button in the upper right corner of the View section (Figure 10-10) allows you to freeze the display at any time. To resume, click the button again. The level meters will remain active while the display is paused.

## Horizontal controls (time axis)

The *Horizontal* controls (Figure 10-11) configure the value range of the x-axis (time). Click and drag the values up or down to set them, or double-click to return to the default value.

There are two modes for the controls: *Zoom/Offset* and *Min/Max*. To change the mode, use the Horizontal control menu (Figure 10-11).



Figure 10-11: Horizontal controls.

In *Zoom/Offset* mode, *Zoom* sets the display zoom from 1/1000x to 10x, where the number represents the number of pixels per sample. For example, when the horizontal zoom value is 10x, 10 samples are displayed in 100 pixels; when the horizontal zoom value is 1/10x, 100 samples are displayed in 10 pixels. *Pos* moves the line marking time equals zero left or right.

In *Min/Max* mode, *Min* and *Max* set the earliest and most recent displayed time.

## Time Units

The *Time Units* sub-menu (Figure 10-11) provides the option to view the X axis in Seconds or Samples.

## Vertical controls (amplitude axis)

The *Vertical* controls (Figure 10-9) operate similarly to the Horizontal controls, except that they configure the y-axis (amplitude).

In *Zoom/Offset* mode, *Zoom* sets the display zoom from 1/2 to 100x, and *Pos* moves the line marking amplitude equals zero line up or down.

In *Min/Max* mode, *Min* and *Max* set the smallest and largest displayed amplitude.

## Waveform Recognition

The Waveform Recognition option (Figure 10-9) searches through new audio data looking for a waveform which most resembles that which was previously displayed. The region where this takes place is a small window around the line marking time equals zero, denoted by the extra vertical graph lines surrounding it. There are two kinds of waveform recognition available: Type I and Type II.

Type I recognition provides the most stable display of the waveform. It is the most resistant to change. Louder transients, such as those produced by a snare drum, are not displayed inside of the waveform window. Type I is best for observing the shape of a signal produced by a synthesizer or observing the tone of a guitar through a chain of pedals.

Type II recognition is less resistant to change. It will include loud transients within the waveform recognition window. Type II is better for observing percussive music where the beat itself is to be centered within the waveform window.

### Trigger

When the *Trigger* (Figure 10-12) is not enabled (the *Trigger* menu is set to *None*), the graph updates based on time: after every  $n$  samples of the monitored audio signal, the most recent samples are displayed. When the *Trigger* is enabled (set to any mode other than *None*), the graph updates in response to specific conditions in the signal. The *Trigger* section defines that criteria and how the graph will display the events that match.

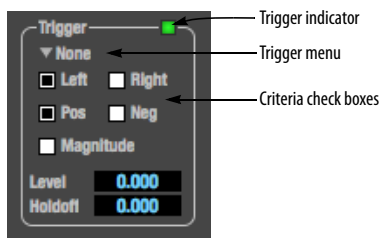

Figure 10-12: Trigger settings.

### Criteria

The criteria checkboxes (Figure 10-12) determine the conditions that the trigger is looking for and where it will look for them.

The *Left* checkbox causes the condition to be looked for in the left channel of the signal; likewise, the *Right* checkbox looks for the condition in the right channel. One or both of

these can be enabled simultaneously. If neither is enabled, the criteria will not be found because the trigger is not looking at any audio signal.

The *Pos* and *Neg* checkboxes determine the slope of the event. When the *Pos* checkbox is enabled, the trigger will look for an event where amplitude is increasing; likewise, enabling the *Neg* checkbox tells the trigger to look for an event where amplitude is decreasing. One or both of these can be enabled simultaneously. If neither is enabled, the criteria will not be found because the trigger is not looking for any particular kind of event.

The *Level* setting defines the amplitude threshold that the trigger is looking for. The *Level* is indicated on the graph by a blue horizontal line (or two blue horizontal lines, if *Magnitude* is enabled). Events which cross this threshold using the enabled slope(s) in the enabled channel(s) will activate the trigger. The response of the trigger is set by the *Trigger* mode (see “*Trigger* modes”, below).

Enabling the *Magnitude* checkbox tells the trigger to look for both positive and negative *Level* values, regardless of whether the *Level* value is positive or negative. For example, if *Level* is set to  $+0.500$  and *Magnitude* is enabled, the trigger will look for both  $+0.500$  and  $-0.500$ . You will see a second blue line appear in the display when *Magnitude* is enabled to denote the second value.

### Holdoff

*Holdoff* defines a time interval during which the oscilloscope does not trigger. The most recent trace will be displayed during that period. When the period is over, the trigger is “re-armed”, i.e. it will begin looking for the criteria again.

Click and drag this value up or down to set it, or double-click to return to the default value.



## Trigger modes

The Trigger menu (Figure 10-12) provides four modes:

### Trigger mode What it does

None	The Trigger is not active; this is the default mode. The incoming audio signal will be displayed continuously as audio is received.
Auto	The display is always updating, but when the condition is met, the trigger event will be displayed centered around the line marking time equals zero.
Normal	The display updates only when the condition is met; the last trace will be displayed until the next matching event is found.
Single Sweep	Similar to Normal mode, but the last trace will be displayed until you manually arm the trigger by clicking the Trigger indicator (Figure 10-12 on page 84) or by pressing the space bar.

## Trigger indicator

The Trigger indicator (Figure 10-12) displays the state of the trigger, and also provides a way to manually interact with it. The Trigger indicator always displays one of three colors:

### Color Status

Green	When the current Trigger criteria has been met (including when the Trigger mode is <i>None</i> ).
Yellow	When the Trigger is armed, but has not yet found an event which matches its criteria. Yellow can also indicate that the graph has been manually paused using the Pause button in the View section (see “Pausing the display” on page 83).
Red	When the Trigger is being held off, either because the Trigger mode is set to Single Sweep or the Holdoff time is not set to zero.

You can also click on the Trigger indicator to force certain actions, depending on the Trigger mode. In Auto and Normal modes, clicking on the Trigger indicator causes the display to run freely; you may click & hold to force this to occur for as long as you’d like. In Single Sweep mode, clicking on the Trigger indicator re-arms the trigger. When the Trigger mode is *None*, clicking on the Trigger indicator has no effect.

## Measurement information

You can view detailed information about a particular time range by using the measurement bars (Figure 10-9).

To adjust the left and right edges of the measurement area, click and drag the blue bars in the graph (Figure 10-9), or click and drag the blue numbers in the upper left or right corners. To reset them to the default value, double-click the numbers.

Information about the measured area is displayed at the center of the top ruler: the duration (in seconds and samples), the approximate frequency, and the scientific note name. If the measured area is long enough, the approximate beats per minute (bpm) is displayed.

## Ideas for using the Oscilloscope

The Oscilloscope can be used in many useful ways during the routine operation of your recording studio. Here are just a few examples.

### Analyzing and comparing harmonic content

The oscilloscope lets you “see” the nature of the harmonic profile in any audio material. You can also view two signals side by side (in stereo mode) to compare their profiles and, if necessary, make adjustments to the source of each signal and view your changes in real time.

### Viewing transients such as drum hits

If you loop a snare hit or other similar transient audio clip and feed it through the oscilloscope, you can more or less “freeze” the transient waveform in the oscilloscope frame. This can be useful, for example, for viewing the results of real-time compression that you are applying with an effects plug-in. For example, when you are compressing a snare hit, as you make adjustment the compressor, you can see the transient waveform change the next time the Oscilloscope triggers. For compression, this can be particularly

useful for balancing the effect of the attack on the transient, relative to the decay portion of the waveform. Conversely, you can see the effect of the threshold setting directly on the decay portion, relative to the attack. In effect, you can see as well as hear the results of your compression adjustments.

To view a transient waveform in the Oscilloscope display, turn off Waveform Recognition and use the *Normal* Trigger mode. Adjust the level high enough to encompass the vertical amplitude of most of the transient. If the transient pulse sweeps across the screen, try raising the Holdoff level. Once the transient is settled in the display and fairly stable, you may need to adjust the horizontal position to center it in the display. You can also pause the display at any time and adjust the horizontal bounds to locate a transient.

### Clip detection

You can use the Oscilloscope to detect clipping in a digital audio signal. To do so, enable all criteria (Figure 10-12), choose *Single Sweep* from the trigger menu (Figure 10-12), set the level to 0.999 and click the trigger indicator (Figure 10-12) to arm it (yellow). As soon as the signal clips, the trigger indicator will turn red, and the display will show the offending clip at the line marking time equals zero.

### Viewing timing pulses

If you have two audio signals with recognizable, timed pulses in them, and you wish to compare their timing with respect to each other, you can use Split Screen or Shared view to visually compare the timing of the two signals. You can zoom in to the sample level for sample accurate viewing.

### Building synthesizer patches

If you are building a synth patch on a synthesizer (or forming similar highly periodic audio material), you can run the audio signal through

the Oscilloscope as you adjust its sound to check in real time for undesirable (and possibly inaudible) characteristics, which are easily seen in the Oscilloscope display. A good example is DC offset. If a signal develops DC offset, the apparent vertical center of its overall waveform will drift above or below the line marking amplitude equals zero. Try setting Waveform Recognition to *Type I* and setting Trigger to *None*.

Another example is waveform polarity. If you are combining several raw waveforms, polarity is a critical, yet not always obvious, factor in determining the resulting sound. You can use the Oscilloscope to easily view and compare polarities to see if they are inverted from one another or not. The *Add* and *Subtract L - R* View menu settings are particularly useful here.

You can also use the Oscilloscope to help you apply waveform modulation and keep it “in bounds”. For example, you could easily see if pulse width modulation is collapsing in on itself to choke the sound, an effect that is readily seen in the Oscilloscope display but not necessarily easy to determine by ear when using multiple modulation sources.

Guitarists can also visually observe the effects of their pedals and processing, while playing. With the Trigger mode set to *None* and Waveform Recognition set to *Type I*, the waveform will be tracked automatically.

When applying filters and filter resonance, the visual effect on the waveform can be invaluable in reinforcing what you are hearing as you make adjustments.

## X-Y PLOT

The *X-Y Plot* window (Figure 10-13) graphs the amplitude of a stereo audio signal on a two-dimensional grid.

For each unit of time (i.e., each sample), the amplitude of the left channel is displayed on the x-axis and the amplitude of the right channel is displayed on the y-axis. A thick white vertical line marks where left channel amplitude equals zero; a thick white horizontal line marks where right channel amplitude equals zero (Figure 10-13). There are also thick white diagonal lines for  $y = x$  and  $y = -x$ .

## Metering

Level meters are displayed above and to the right of the graph for the left (green) and right (red) channels, respectively. An additional *Correlation meter* (blue) is displayed on the right. This meter displays the correlation between the two channels.

The higher the meter, the higher the correlation between the two channels. Below are a few examples:

Situation	Meter level	X-Y Plot graph	Mathematical relationship
Perfect correlation	+1	Diagonal line going from lower left to upper right:	$y = x$
Zero correlation	0	No discernible pattern	None
Perfectly out of phase-1		Diagonal line going from upper left to lower right:	$y = -x$

## View controls

The View controls (Figure 10-14) provide several options for the X-Y Plot display.

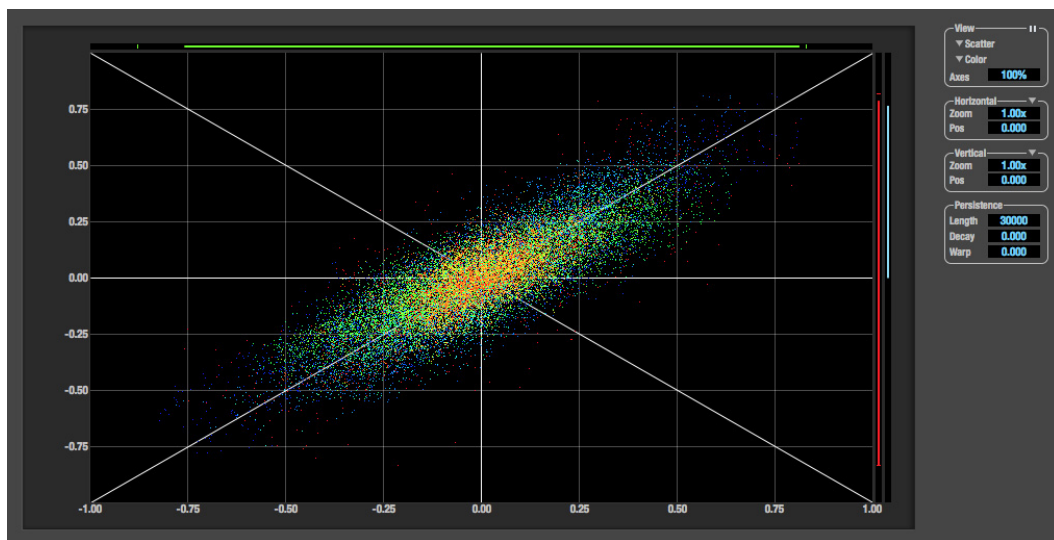

Figure 10-13: X-Y Plot.



Figure 10-14: View controls.

### Pausing the display

The Pause button in the upper right corner of the View section (Figure 10-14) allows you to freeze the display at any time. To resume, click the button again. The level meters will remain active while the display is paused.

### Line/Scatter

Choose either *Line* or *Scatter* from the menu in the View section (Figure 10-14) to plot each point (sample) as either a single pixel or as a continuous line that connects each plot point to the next, as shown below in Figure 10-15.

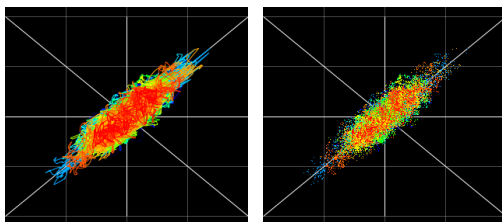

Figure 10-15: The same X-Y Plot displayed in Line versus Scatter mode.

Line mode is significantly more CPU intensive than Scatter. You can reduce Line mode CPU overhead on the X-Y Plot by reducing the Length parameter (described below).

### Color/Grayscale

In *Color* mode (Figure 10-14) the most recently displayed audio data is shown in red, which fades to yellow, green and then finally blue, before disappearing. In Grayscale mode, data is first

shown in white and then fades to gray. To adjust the scale of this color/brightness change, see “Decay” on page 89.

### Axes

The *Axes* control (Figure 10-14) sets the opacity of the grid displayed in the graph, from 100% (fully visible) down to 0% (fully hidden).

### Horizontal and vertical controls

The *Horizontal* and *Vertical* controls (Figure 10-16) configure the value range of the x-axis (left channel amplitude), and y-axis (right channel amplitude), respectively. Click and drag the values up or down to set them, or double-click to return to the default value.

There are two modes for the controls: *Zoom/Offset* and *Min/Max*. To change the mode, use the menu shown in Figure 10-16.

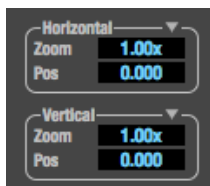

Figure 10-16: Setting the Horizontal or Vertical control modes.

In *Zoom/Offset* mode, *Zoom* scales the axis. *Pos* moves the lines marking  $x = 0$  left and right, or  $y = 0$  up and down.

In *Min/Max* mode, *Min* and *Max* let you scale the grid by moving the  $-1.0$  and  $+1.0$  points along the axis. *Min/Max* mode lets you control the graph boundaries directly.

### Persistence

The *Persistence* controls (Figure 10-17) affect the appearance of data from when it is first displayed until it disappears from the grid.

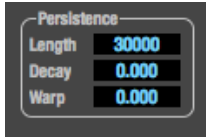

Figure 10-17: The Persistence controls.

### Length

*Length* (Figure 10-17) sets the number of recent samples to show on the plot. For example, when Length is set to 10,000, the 10,000 most recent samples are shown.

### Decay

The brightness (in Grayscale mode) or hue (in Color mode) of each sample on the plot is determined by a linear scale, with the most recent sample displayed at the maximum value and the oldest sample displayed at the minimum value.

*Decay* (Figure 10-17 on page 89) determines the brightness or hue of the minimum value. When Decay is zero, the oldest sample is black. When Decay is +1.000, the oldest sample is fully opaque (in Grayscale mode) or red (in Color mode).

### Warp

*Warp* (Figure 10-17) determines the position of data points after they are first drawn. When warp is zero, data points remain in the same position. When warp is positive, they contract towards the

origin (center of the grid). When warp is negative, they expand away from the origin. The further the warp value is from zero, the greater the effect.

### Using the X-Y Plot

The X-Y Plot helps you “see” the width of the stereo field of a mix (Figure 10-18). It also helps you determine if a mix has issues with polarity, as follows:

Activity on the X-Y Plot	What it indicates
Signal activity occurs mostly along the $x = y$ axis (lower left to upper right) and the Correlation meter reading is high	Left and right channels are predominantly in polarity (the stereo field is relatively narrow)
Signal activity occurs mostly along the $y = -x$ axis (upper left to lower right) and the Correlation meter reading is low (near -1)	Left and right channels are predominantly out of polarity (not in phase)
Signal activity occurs in a seemingly random fashion throughout the grid	No phase relationship exists (i.e. it is probably a wide stereo field)

If a stereo signal is out of phase, it is not mono compatible because it can cancel itself out, either partially or nearly completely, when collapsed to mono.

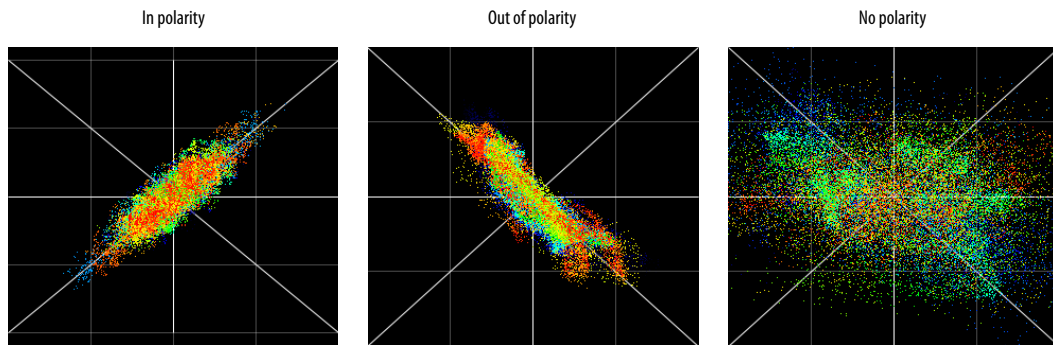

Figure 10-18: Checking polarity in a stereo signal with the X-Y Plot.

## PHASE ANALYSIS

The *Phase Analysis* window (Figure 10-19) graphs frequency versus phase difference versus amplitude of a stereo signal on either rectangular or polar coordinates.

In rectangular coordinates, the vertical axis represents frequency, and the horizontal axis represents the phase of the left channel minus the phase of the right channel (measured in radians).

In polar coordinates, the radius represents frequency and the angle (theta) from the +y vertical axis represents the phase difference of left channel minus the right channel.

### Correlation Meter

The blue *Correlation Meter* to the right of the display shows the correlation between the two channels. The higher the meter, the higher the correlation between the two channels.

## View controls

The View controls (Figure 10-20) provide several options for the Phase Analysis display.

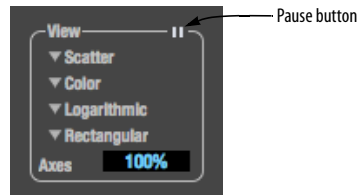

Figure 10-20: View controls.

### Pausing the display

The Pause button in the upper right corner of the View section (Figure 10-20) allows you to freeze the display at any time. To resume, click the button again. The correlation meter will remain active while the display is paused.

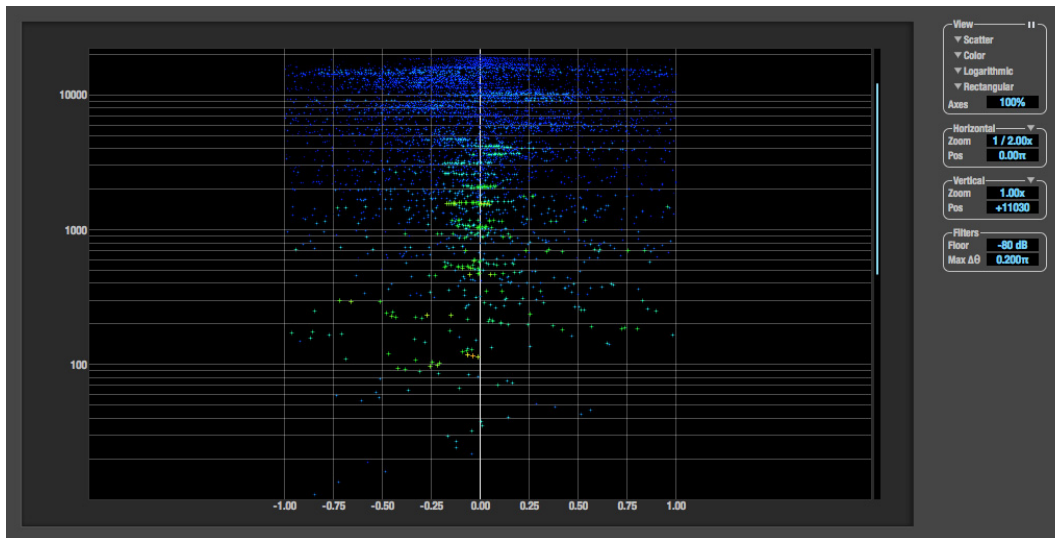

Figure 10-19: Phase Analysis.

### Line/Scatter

Choose either *Line* or *Scatter* from the menu in the View section (Figure 10-20) to plot each data point as either a single pixel or as a continuous line that connects each frequency data point to the next, as shown below in Figure 10-15.

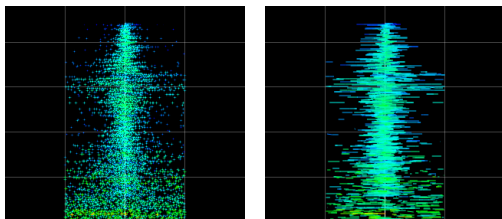

Figure 10-21: The same Phase Analysis displayed in Line versus Scatter mode.

☞ Line mode is significantly more CPU intensive than Scatter. You can reduce Line mode CPU overhead for the Phase Analysis display by increasing the Floor filter and reducing the Max Delta Theta filters (see “Filters” on page 92).

### Color/Grayscale

In *Color* mode (Figure 10-20) signal amplitude is indicated by color as follows: red is loud and blue is soft. In grayscale mode, white is loud and gray is soft.

### Linear/Logarithmic

Choose either *Linear* or *Logarithmic* from the menu in the View section (Figure 10-20) to change the scale of the frequency axis. In rectangular coordinates, the vertical axis represents frequency, and in polar coordinates, the radius from the center is frequency. With a linear scale, frequencies are spaced evenly; in a logarithmic scale, each octave is spaced evenly (frequencies are scaled logarithmically within each octave).

Linear is better for viewing high frequencies; logarithmic is better for viewing low frequencies.

### Rectangular/Polar

Choose either *Rectangular* or *Polar* from the menu in the View section (Figure 10-20) to control how audio is plotted on the Phase Analysis grid. *Rectangular* plots the audio on an X-Y grid, with frequency along the vertical axis and phase difference on the horizontal axis. *Polar* plots the data on a polar grid with zero Hertz at its center. The length of the radius (distance from the center) represents frequency, and the angle (theta) measured from the +y (vertical) axis represents the phase difference in degrees.

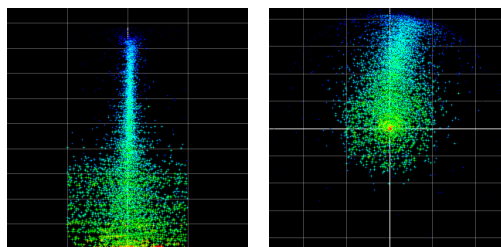

Figure 10-22: Rectangular versus Polar display (with a linear plot).

Above, Figure 10-22 shows Rectangular versus Polar display with a Linear plot. Below, Figure 10-23 shows the same displays (and the same data) with a Logarithmic plot:

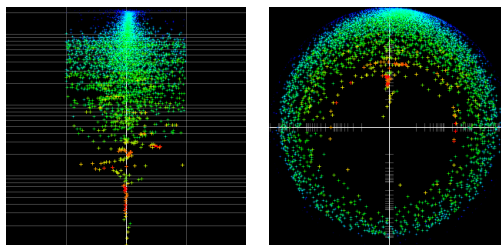

Figure 10-23: Rectangular versus Polar display with a logarithmic plot.

### Axes

The *Axes* control (Figure 10-20) sets the opacity of the grid displayed in the graph, from 100% (fully visible) down to 0% (fully hidden).

## Horizontal and vertical controls

The *Horizontal* and *Vertical* controls (Figure 10-24) let you scale each axis of the grid and offset its zero point. Click and drag the values up or down to set them, or double-click to return to the default value.

There are two modes for the controls: *Zoom/Offset* and *Min/Max*. To change the mode, use the menu shown in Figure 10-24.

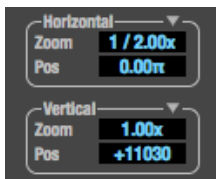

Figure 10-24: Setting the Horizontal or Vertical control modes.

In *Zoom/Offset* mode, *Zoom* scales the axis. *Pos* moves the zero line.

In *Min/Max* mode, *Min* and *Max* let you scale the grid by moving the end points along the axis. *Min/Max* mode lets you set the boundaries of the graph directly.

## Filters

The *Filters* section (Figure 10-25) lets you control the density of the Phase Analysis display.



Figure 10-25: Filters.

### Floor

*Floor* (Figure 10-25) determines the amplitude threshold for the display. When the amplitude of both channels drops below this threshold, the signal is not shown.

### Max delta theta

*Max delta theta* (Figure 10-25) only affects Line view (see “Line/Scatter” on page 91) and sets the maximum difference in frequency between plot points in the line plot. For two adjacent frequencies, if the distance (phase difference) between the two frequencies is greater than the *Max delta theta*, then the line is not drawn.

## Using the Phase Analysis

In the polar display (top row of Figure 10-26 on page 93), stereo material that is predominantly phase-aligned (correlated) appears along the vertical axis, as demonstrated in the first column (*Perfectly in phase*) in Figure 10-26. If the vertical line tilts left or right, this indicates general differences in phase; the more the tilt (delta theta), the more the phase difference. If the vertical line points downwards in the polar display, this indicates that the stereo image is predominantly out of polarity, as demonstrated by the fourth column (*Inverted*) in Figure 10-26. Delays appear as spirals in the polar display.

The rectangular display (bottom row of Figure 10-26) also shows a predominantly phase-aligned stereo image along the vertical axis, and tilt (or left-right offset) from the center vertical axis represents differences in phase. If a signal is predominantly out of polarity, it appears along the  $\theta = -1.0$  or  $\theta = +1.0$  lines in the rectangular display, as demonstrated in the fourth column (*Inverted*) in Figure 10-26 on page 93.

### Using Phase Analysis for multiple mic placement

The polar display can be very useful when recording drums or another instrument with multiple microphones. The slight delays caused by the differences in distance to the source can often create a comb filtering (delay) effect between two mic signals, due to phase cancellation. These comb filter effects appear as spirals in the polar display. If you arrange the mics so that the null points (where the spiral pattern meets the negative



y axis) are outside the critical frequency range of the instrument being recorded, you can avoid phase problems among the mic signals.

### Tuning PA systems

The Phase Analysis window can also be used to troubleshoot and tune PAs and sound reinforcement systems by placing microphones in strategic locations, comparing the two signals in the Phase Analysis grid and looking for phase issues at various locations.

### Summing to mono

The Phase Analysis window is ideal for checking stereo audio that needs to be summed to mono. The Phase Analysis lets you see what frequencies will be canceled out when summed.

In the rectangular view, any lines in the signal that touch the +1.0 or -1.0 vertical lines in the grid will be canceled out at the frequency where they touch, when the signal is summed to mono.

In the polar view, any signal that falls on the negative y axis (below zero) will be canceled out when the signal is summed to mono.

### Checking for phase issues in stereo tracks

You can use the Phase Analysis window to check the overall polarity of a stereo mix. Figure 10-27 is an example of a full stereo mix that has phase issues, as indicated by the majority of the signal's energy, which is predominantly skewed to the left side of the rectangular view (left) and spread along the -y axis in the polar view (right).

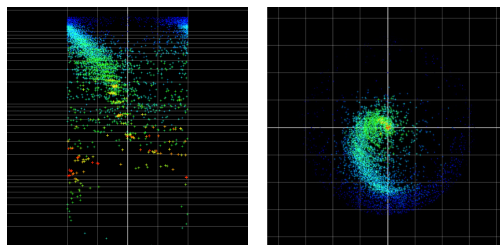

Figure 10-27: A stereo mix with phase issues.

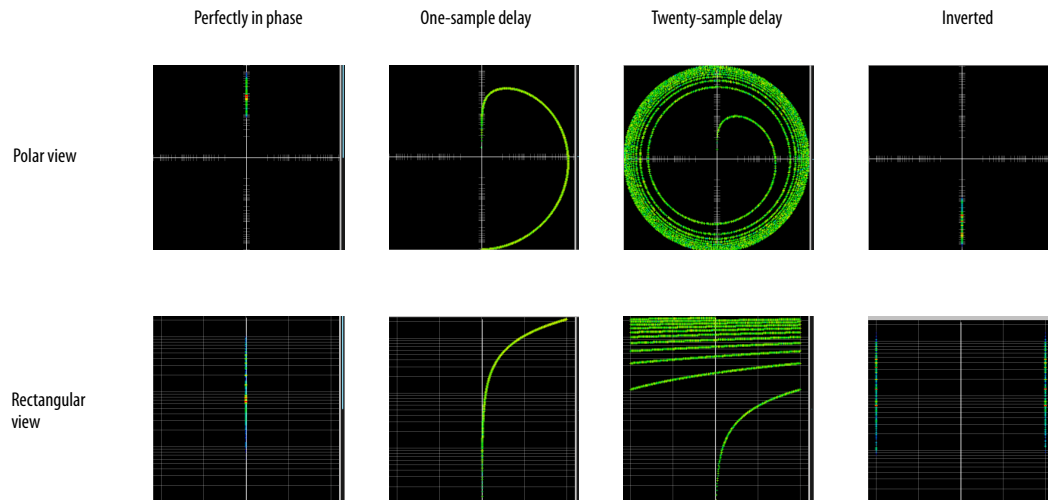

Figure 10-26: Two identical audio streams in the Phase Analysis.



# CHAPTER 11 Networking

## OVERVIEW

The Audio Video Bridging (AVB) network port on the 828es opens up a world of possibilities for creating expanded, customized audio network systems.

About AVB.....	95
MOTU's AVB implementation.....	96
Networking examples.....	97
A quick guide to networking.....	98
Setting up a MOTU interface for networking.....	99
Mapping audio to network streams.....	99
Mapping computer channels to network streams.....	99
Device presets and AVB stream connections.....	100
Bridging to Ethernet.....	100
The MOTU AVB Switch.....	100

## ABOUT AVB

Audio Video Bridging (AVB) is an extension of the Ethernet standard developed by the IEEE (802.1 standards committee) specifically to add high-performance audio and video networking.

☛ You may also hear AVB referred to as *AVB/TSN* or simply *TSN* because the IEEE is in the process of renaming the standard to *Time Sensitive Networking* to accommodate the expanding scope of the specification to applications beyond audio and video.

AVB brings together the worlds of networking technology and high-end audio. Here is a brief summary of some of the immediate benefits of AVB for you, as a MOTU interface user:

- An open industry standard — AVB has been developed by the IEEE as an international standard specification. It is not proprietary or controlled by one company.

- High channel counts — AVB provides hundreds of network channels.

- Extremely low latency — AVB guarantees low-latency, real-time performance.

- Guaranteed Quality of Service (QoS) — AVB's Stream Reservation Protocol provides Guaranteed Quality of Service for each and every audio stream. If the network cannot continuously maintain every bit of every sample in the audio stream, it will not allow you to make the network connection in the first place. AVB streams are prioritized over other network traffic to ensure high performance.

- Network-wide clocking and sync — AVB devices all clock together over your network for better-than-sample-accurate phase lock across all connected devices. Timing accuracy is down to the nanosecond.

- True plug-and-play operation — AVB has been designed from the ground up to provide automatic device discovery, enumeration, and connection management. Just plug the 828es into a standard AVB switch and go. If you wish to make stream connections and have the ability to select media clock, you must use the web app, or some other AVB controller. You don't need an IT professional to configure the network. AVB is a self-managing network protocol.

- Bridging to standard Ethernet — AVB cooperates with standard Ethernet networks, for connecting traditional Ethernet devices like wireless routers, switches, or any other non-AVB-aware device.

- Support for existing network infrastructure — Replace your existing switches with standard AVB-compatible switches, and your CAT-5e or CAT-6 wired infrastructure now supports AVB.
- Long cable runs — a single AVB network connection can run up to 100 meters with a standard copper wire CAT-5e or CAT-6 cable. Fiber-optic cable runs can be much longer. With multiple switches, you can create a network that covers very large distances, if necessary. You can use up to seven “hops” (switch-to-switch connections).
- AVB is already shipping on current Macs — Apple supports AVB on all current shipping Macs, and the 828es can operate as a standard AVB audio interface when connected to your Mac’s AVB-equipped Ethernet port.

### **MOTU’S AVB IMPLEMENTATION**

MOTU engineering has faithfully implemented the IEEE 802.1 AVB standard for the MOTU AVB products. This means that MOTU devices are fully inter-operable with any 3rd party AVB-compatible device. In addition, MOTU has fine-tuned AVB operation among MOTU devices for optimum performance, within the AVB specification. Here is a brief summary of advantages you will enjoy when using MOTU devices together in a network:

- Up to 256 channels of host I/O — MOTU interfaces (depending on the model) can support up to 256 simultaneous channels of audio I/O (128 in, 128 out) to and from the entire network through Thunderbolt or USB 3.0.
- Support for multiple computer hosts — All computers and all network devices run in sync with each other, resolved to the network’s master clock.
- Gigabit Ethernet — The MOTU AVB Switch delivers 1 Gbit Ethernet performance, which provides substantially higher bandwidth than 100 Mbit Ethernet. This allows you to have many more devices on the AVB network.
- Over 500 channels of network audio — MOTU’s AVB network can stream over 500 channels of audio throughout the network. Depending on the model, some MOTU devices can broadcast sixteen 8-channel network streams and simultaneously listen to sixteen 8-channel network streams.
- Exceptionally low network latency — Standard AVB network latency is 2 ms. MOTU AVB network latency is an astonishing 0.6 ms, even over seven “hops” (switches) and hundreds of meters of cable. By comparison, other commercially available, proprietary audio network protocols have variable (unpredictable) network latency in the range of 2-5 ms.
- Star configuration — MOTU AVB supports a star network configuration, which is much more flexible than daisy-chain scenarios, which depends on all devices in the chain.
- Web interface — MOTU AVB devices can be controlled from the MOTU Pro Audio Control web app, which runs within any web browser on any networked laptop, tablet, or smart phone. Although the web app shares the network with AVB, AVB audio streams are never compromised because AVB streams over the network traffic.
- Bridging to standard Ethernet — the MOTU AVB Switch provides an extra standard Ethernet port for bridging to your local Ethernet network, Wi-Fi, etc. for command and control, internet access, and other standard network traffic. All ports allow connection to standard (non-AVB) network devices, however, the “Ethernet” port is suggested because it does not support AVB.

## NETWORKING EXAMPLES

Networking comes into play as soon as you hook up a second MOTU interface to your first one, as explained in “Setup for two interfaces” on page 34, to add more I/O to your studio. Here are just a few examples of what is possible.

### Personal studio expansion

Let’s say you have an 828es next to your computer. You could add an 8M interface and position it across the room, near your drum kit, for placing up to 8 mics on the drums. All the mic cabling is kept near the drums, and you have one simple, clean network cable running back to your computer system. Despite the distance, the two interfaces operate as a seamless system, controlled from your computer or iPad.

### Studio installation

A studio installation of three to five interfaces can be handled with a single MOTU AVB Switch. See “Setup for three to five interfaces” on page 35.

Networking is ideal for studio installation because you can position interfaces at strategic locations. Running cables becomes much simpler and more cost effective. Not only does a setup like this give you access to all I/O from your computer, even multiple computers, you can also route audio from any input to any output across devices with near zero latency. You can also route audio from one computer to another with very low latency. As a simple example, you could deploy several interfaces in a studio as follows:

Interface	Location	Purpose
24Ao	Control room	Multi-channel output in control room for main monitors, secondary monitors, surround, etc.
1248	Iso booth	Local mic and instrument I/O in the iso booth.
828es	Studio room	Local inputs and monitoring system for musicians.
8M	Studio room	More mic inputs, or additional mic inputs for drum kit
8M	Studio room drum kit	8 more mics on the drum kit
24Ai	Machine room	Analog inputs for hardware synths, outboard returns, etc.

### Large studio facility

In a larger studio facility, you could build audio network neighborhoods similar to the studio installation described earlier in multiple rooms, even multiple floors, with multiple computers and Wi-Fi control from anywhere in the facility. All computers and devices can see each other and you can stream audio anywhere on the network with near-zero latency, as if any two devices were connected directly to each other.

### Concert systems

Concert systems must be flexible so they can adapt to each new venue while on tour. Because of its modular nature, AVB networking allows you to design systems that are scalable and easy to adapt to each venue. You can easily bring devices on and offline, rerouting audio stems as needed.

Because MOTU AVB networking employs a star configuration, instead of daisy-chaining, you can set up backup computer playback systems on a shared network. For example, in a concert setting, if one computer system goes down, the backup system can be brought on line instantly through the same network infrastructure.

Traditionally, live performance setups often have separate domains for front of house mixing, monitor mixing, computer backline, and other

systems. With MOTU AVB networking, these systems can be unified on the same network, opening up many possibilities for shared resources and mixing/routing responsibilities, especially from multiple sources (laptops, iPads, tablets, etc.) MOTU AVB networking handles audio in convenient 8-channel stems, making large-scale network management more manageable. MOTU AVB's very low latency makes it particularly suitable for line arrays and sound reinforcement.

### Large-scale venues

With long cable runs and industry standard networking infrastructure, MOTU AVB systems are well-suited for large-scale commercial installations such as arenas, stadiums, theme parks, clubs, casinos, houses of worship, broadcast facilities, schools, universities, and so on. Audio streams can travel long distances with sub-millisecond latency through as many as seven switches. Audio can be distributed from a centralized location to anywhere in the venue.

### A QUICK GUIDE TO NETWORKING

MOTU AVB networking has been designed to be powerful, yet straightforward to set up and use. Here are a few things that are useful to know.

#### Networking basics

- Before proceeding below, review the networking connection diagrams on pages 34-36.
- To make network connections, use shielded CAT-5e or CAT-6 cables (a higher grade cable).
- Network cable lengths can be long: 100 meters with standard copper wire cables; much longer with fiber-optic network cables.

#### Working with AVB switches

- Networks of three or more interfaces require an AVB-compatible switch. You can use any standard AVB switch on the market. MOTU offers the five-port MOTU AVB Switch™ (sold separately).

☛ A non-AVB compatible switch will not work.

- Connect MOTU interfaces to any AVB Switch using their NETWORK ports.
- On the MOTU AVB Switch, connect MOTU interfaces to the five AVB NETWORK ports (not the Ethernet port). Connect the Ethernet port to a Wi-Fi router, your Local Area Network (LAN) or your computer (for running web app only).

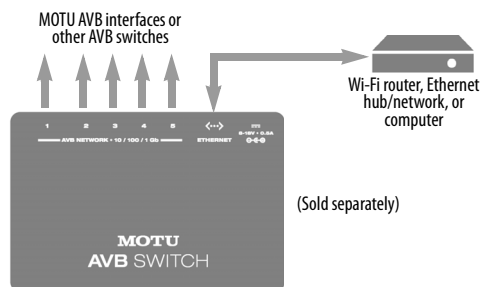

- Expand the network by adding more switches. Make a single connection from one switch to the other. On MOTU AVB Switches, use their AVB NETWORK ports, NOT the Ethernet port.
- You can daisy-chain switches in serial fashion, but don't create loops. For example, in the network below, do not make any additional connections between any two switches.

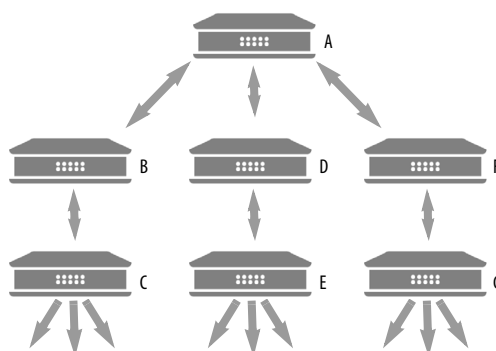

- AVB audio can't pass through more than seven switches. However, you can daisy-chain more than seven switches and route audio freely among

them. You just won't be able to create point-to-point connects that span more than seven switches.

### **Working with computers on a network**

- Computers are not required for network operation, as you can control the network from iPads, tablets and smart phones.
- To add computers to the network, connect them to any interface using Thunderbolt (which offers the highest possible channel counts). If Thunderbolt is not available, use USB.
- A computer can be connected to the network through its Ethernet port, but only for the purposes of running the web app on the computer for command and control over the network. (In this scenario, you won't be able to stream audio to/from the network from the computer.)
- All computers and interfaces on the network have full access to each other.
- MOTU employs a 1 Gbit AVB implementation in the MOTU AVB Switch. The switch allows routing of many audio channels on the network.

### **SETTING UP A MOTU INTERFACE FOR NETWORKING**

Depending on the model, MOTU interfaces have the ability to broadcast up to sixteen 8-channel streams to the rest of the network. Conversely, it can "listen" to as many as sixteen 8-channel streams from anywhere else in the network. The specific number of streams supported depends on the model.

For each device on the network, set it up for network operation as follows:

**1** In the MOTU Pro Audio Control web app, choose the device (item #1 on page 12).

**2** Go to the Device tab (item #5 on page 12), go to the *AVB Stream Setup* section (item #21 on page 13), and type in the number of 8-channel input and output streams you want for that device.

**3** Go to the *AVB Stream Connections* section (item #22 on page 13), and choose the network stream you want the device to listen to for each bank.

**4** Use the Routing tab to map specific I/O channels within each MOTU interface to its network input and output streams, as explained in the next section.

### **MAPPING AUDIO TO NETWORK STREAMS**

Once you've configured a device's AVB streams, as explained above, use the Routing tab (page 15) to map audio channels to network input and output streams.

Input streams (coming from the rest of the network) are listed across the top of the routing grid. Expand the stream and click on the grid to map incoming network channels to local destinations, including physical outputs on the device, computer channels (to a connected computer), or mixer channels.

Output streams being broadcast to the rest of the network are listed in rows along the left side of the grid. Expand each stream bank and map individual network output channels to local sources, such as physical inputs on the interface, channels coming from the computer, or channels coming from the device's mixer.

### **MAPPING COMPUTER CHANNELS TO NETWORK STREAMS**

If a host computer is connected to an interface (through USB), mapping network input and output streams is accomplished as described in the

previous two sections. Simply enable AVB streams as desired, and map them to computer channels in the Routing grid.

If, while mapping, you run out of computer channels, enable more in the *Computer Setup* section of the Device tab (item #26 on page 14). If the computer is connected with Thunderbolt or USB 3.0 (to a MOTU interface that supports it), you can enable a maximum of 128 channels in and out. If the computer is connected with USB 2.0, performance will vary, depending on the sample rate and other factors.

### **DEVICE PRESETS AND AVB STREAM CONNECTIONS**

When you save a preset for a MOTU device (item 7 on page 12), any AVB stream connections that it has established with other devices on the network are now included with the saved preset. When you recall the preset, those saved stream connections are restored, as long as the other devices are still present on the network and broadcasting the same streams. If the other device is not present (or perhaps turned off), its streams will be reported as “off line”.

In general, if you have multiple devices on a network with interconnecting AVB streams, and you wish to preserve the state of the network, it is recommended that you save a device preset for each device on the network. Doing so will allow you to faithfully restore the entire network stream configuration by recalling each device’s saved preset.

### **BRIDGING TO ETHERNET**

The Ethernet port on the MOTU AVB Switch allows you to connect standard network devices, such as:

- A Wi-Fi router
- An Ethernet hub or switch connected to a local home, studio, or office network
- Any other standard networking device

### **THE MOTU AVB SWITCH**

The heart of a MOTU AVB network is the MOTU AVB Switch (sold separately). For a brief overview of the switch and its features, visit:

[www.motu.com/products/avb/avb-switch](http://www.motu.com/products/avb/avb-switch).



*Part 3*

*Appendices*



## APPENDIX A Troubleshooting

*Some or all of my MOTU interface inputs and outputs are not available in my host audio software.* Make sure that the inputs and outputs are enabled in the Device tab (“Device tab” on page 12) and routed to and from the computer in the Routing tab (“Routing tab” on page 15). For details, see “Making inputs and outputs available to your host software” on page 68. A quick and easy way to do this is to choose the Audio Interface preset from Quick Setup (item 10 on page 12).

*I have absolutely no audio input or output happening to or from my interface. Why?* Make sure that the unit has a stable sample rate (the sample rate will flash if the clock hasn’t settled yet). Try setting the unit’s clock source to *Internal* if you can’t sync to any external clock sources. Check that audio is working with Internal sync, and if so, then work on establishing a stable external clock.

*I can’t hear computer audio output through my MOTU interface.* In the Sound panel of System Preferences, the 828es should be selected as the output device. Almost all applications will use just the first two output channels, so make sure that *From Computer 1* and *From Computer 2* are routed to the physical outputs that you are listening to in the Routing tab (e.g. Phones 1-2 or Analog 1-2).

*How do I monitor live inputs?* Please refer to the documentation for the audio application that you are using. If your application does not support input monitoring, you will need to use the mixer in the 828es. Please see “Monitoring through the 828es” on page 65.

*How do I control monitoring latency?* See “Reducing monitoring latency” on page 64.

*The Routing tab (page 15) doesn’t display some of the inputs or outputs on my interface.*

The Routing tab only displays input and output banks that are enabled in the Device tab (page 12), so be sure any banks you wish to work with are enabled there. However, to conserve DSP resources and help consolidate screen-space in the other tabs, it is efficient practice to disable unused input or output banks (optical banks, for example, when only working with analog banks, or all output banks when only working with Phones).

*I’m getting a “Could not enable this effect because DSP is overloaded” error. What should I do?* Disable other effects or reduce the number of mixer inputs to conserve DSP resources. If there are audio input and output banks on your interface that you are not using (such as the optical banks), disable them in the Device tab (page 12).

*I accidentally deleted my factory presets. How do I restore them?* In the Device tab (page 12), click the *Restore Factory Presets* button to restore all factory presets.

*How do I factory reset my device?* Push the MENU knob to enter the main menu. Navigate to *Settings > Factory Default* and push the MENU knob twice to reset.

*I hear clicks and pops under word clock sync.* Many problems result from incorrect word clocking. It is essential that all digital devices in the system be word locked. Consult “Synchronization” on page 46 for detailed information on how to word clock your gear. Whenever there is any unexpected noise or distortion, suspect incorrect word lock.

### *Clicks and pops due to hard drive problems...*

If you have checked your clock settings and you are still getting clicks and pops in your audio, you may have a drive related problem. Set your Clock Source to *Internal* and try recording just using the analog inputs and outputs on the 828es. If you encounter the same artifacts you may want try using another drive in your computer. Clicks and pops can also occur when the drive is severely fragmented or there are other drive-related issues.

### *Connecting or powering gear during operation...*

It is not recommended that you connect/disconnect, or power on/off devices connected to the 828es while recording or playing back audio. Doing so may cause a brief glitch in the audio.

## **CUSTOMER SUPPORT**

We are happy to provide complimentary customer support to our registered users. If you haven't already done so, please take a moment to register online at MOTU.com, or fill out and mail the included registration card. Doing so entitles you to technical support and notices about new products and software updates.

## **TECHNICAL SUPPORT**

If you are unable, with your dealer's help, to solve problems you encounter with your MOTU device, you may contact our technical support department in one of the following ways:

- Tech support hotline: (617) 576-3066 (Monday through Friday, 9 a.m. to 6 p.m. EST)

- Online support: [www.motu.com/support](http://www.motu.com/support)

Please provide the following information to help us solve your problem as quickly as possible:

- The serial number of your MOTU device. This is printed on a label placed on the bottom of the rack unit. It is also displayed at the bottom of the Device tab in the MOTU Pro Audio Control web app (item #30 on page 14). You must be able to supply this number to receive technical support.
- A brief explanation of the problem, including the exact sequence of actions which cause it, and the contents of any error messages which appear on the screen.
- The pages in the manual that refer to the features or operation of your MOTU Device or AudioDesk with which you are having trouble.
- The version of your computer's operating system.

We're not able to solve every problem immediately, but a quick call to us may yield a suggestion for a problem which you might otherwise spend hours trying to track down.

If you have features or ideas you would like to see implemented, we'd like to hear from you. Please write to the Development Team, MOTU Inc., 1280 Massachusetts Avenue, Cambridge, MA 02138, or use our online suggestion box at [www.motu.com/suggestions](http://www.motu.com/suggestions).

## APPENDIX B Audio Specifications

### MIC in

Connector Type	Combo-style, XLR / TRS	Pin 2 hot, tip hot
----------------	------------------------	--------------------

### XLR

Impedance load	2.65 k ohm	
Pad	-20 dB, Switchable per channel	
Phantom power	+48 v, switchable per channel	DIN 45596 / IEC 61938-P48
EIN	-128 dBu	XLR Terminated
Dynamic Range	118 dB	A-weighted
THD+N	-107 dB	Unweighted
Frequency Response	+0 -0.1 dB, 20 Hz/20 kHz	Ref. 1 kHz
Max Level In with Pad	+24 dBu	
Max Level In without Pad	+5 dBu	
Trim range	0 to +63 dB in 1 dB steps	

### TRS

Description	Balanced or single ended	Suitable for line or instrument (guitar)
Impedance Load	1 meg ohm	differential
Pad	-20 dB, Switchable per channel	
Phantom power	No	
Dynamic Range	118 dB	A-weighted
THD+N	-107 dB	-2 dBFS, Unweighted
Frequency Response	+0 -0.1 dB, 20 Hz/20 kHz	Ref. 1 kHz
Max Level in with Pad	+17 dBu	
Max Level in without Pad	+5 dBu	
Trim range	0 to +63 dB in 1 dB steps	

**Line In**

Connector Type	1/4" Female, TRS	Balanced/unbalanced, Tip hot
Specification	Complies with EBU-R68 / SMPTE RP-155	
Impedance Load	10 k ohm	
Dynamic Range	117 dB	A-weighted
THD+N	-108 dB	-2 dBFS, Unweighted
Frequency Response	+0, -0.1 dB, 20 Hz/20 kHz	Ref. 1 kHz
Max Level In	+24 dBu	
Trim Range	-96 dB to 22 dB	Boost +2 dBu to +24 dBu in 1 dB steps

**Line Out**

Connector Type	1/4" Female, TRS	Balanced, tip hot
Output Impedance	100 ohm	Per leg
Dynamic Range	123 dB	A-weighted
THD+N	-108 dB	-2 dBFS, Unweighted, 1 kHz
Frequency Response	+0, -0.1 dB, 20 Hz/20 kHz	Ref. 1 kHz
Max Level Out	+20 dBu	
Trim Range	24 dB	-4 dBu to +20 dBu in 1 dB steps

**Main Out**

Connector Type	XLR Male	
Output Impedance	100 ohm	Per leg
Dynamic Range	123 dB	A-weighted
THD+N	-109 dB	-2 dBFS, Unweighted, 1 kHz
Frequency Response	+0, -0.1 dB, 20 Hz/20 kHz	Ref. 1 kHz
Max Level Out	+20 dBu	
Trim Range	24 dB	-4 dBu to +20 dBu in 1 dB steps

### Phones

Connector Type	1/4" Female, TRS Stereo	Tip Left, Ring Right
Dynamic Range	108 dB	A-Weighted
THD+N	-100 dB	Unweighted
Frequency Response	+0 -0.15 dB, 22 Hz/20 kHz	Ref. 1 kHz
Drive	Max. 80 mw	16/32/55 ohms
Trim Range	128 dB	0 to -128 dB (muted) in 1 dB steps

### S/PDIF

Connector Type	RCA	
Termination	75 ohm I/O	
Lock Range	44.1k/48k, +/- 0.5%	1x, 2x
Input Voltage Range	0.2 Vpp/1Vpp	With termination
Output Drive	0.5.0 Vpp With termination	DC coupled
THD+N In	-122 dB	Unweighted
Specification	IEC-958/60968-3	

### Word Clock In/Out/Thru

Specification	AES-11 2009 Annex B	
Connector Type	BNC	
Termination	75 ohm (in/out)	THRU is unterminated
Lock Range	44.1 kHz / 48kHz, +- 0.5%	x1/x2/x4
Input	1 vpp to 3 v p-p (with termination)	AC coupled
Output	5.0 vpp, (2.5 v p-p terminated)	DC coupled
Jitter	complies with AES3-4-2009	< 0.025 UI

### Power Supply

Connector Type	IEC 3-conductor receptacle	For AC mains connection
Configuration	Internal, Universal	
Power Input	100 V to 240 V, 50 Hz or 60 Hz	
Power Usage	35 watts	





# APPENDIX C Mixer Schematics

## MONO INPUT CHANNEL

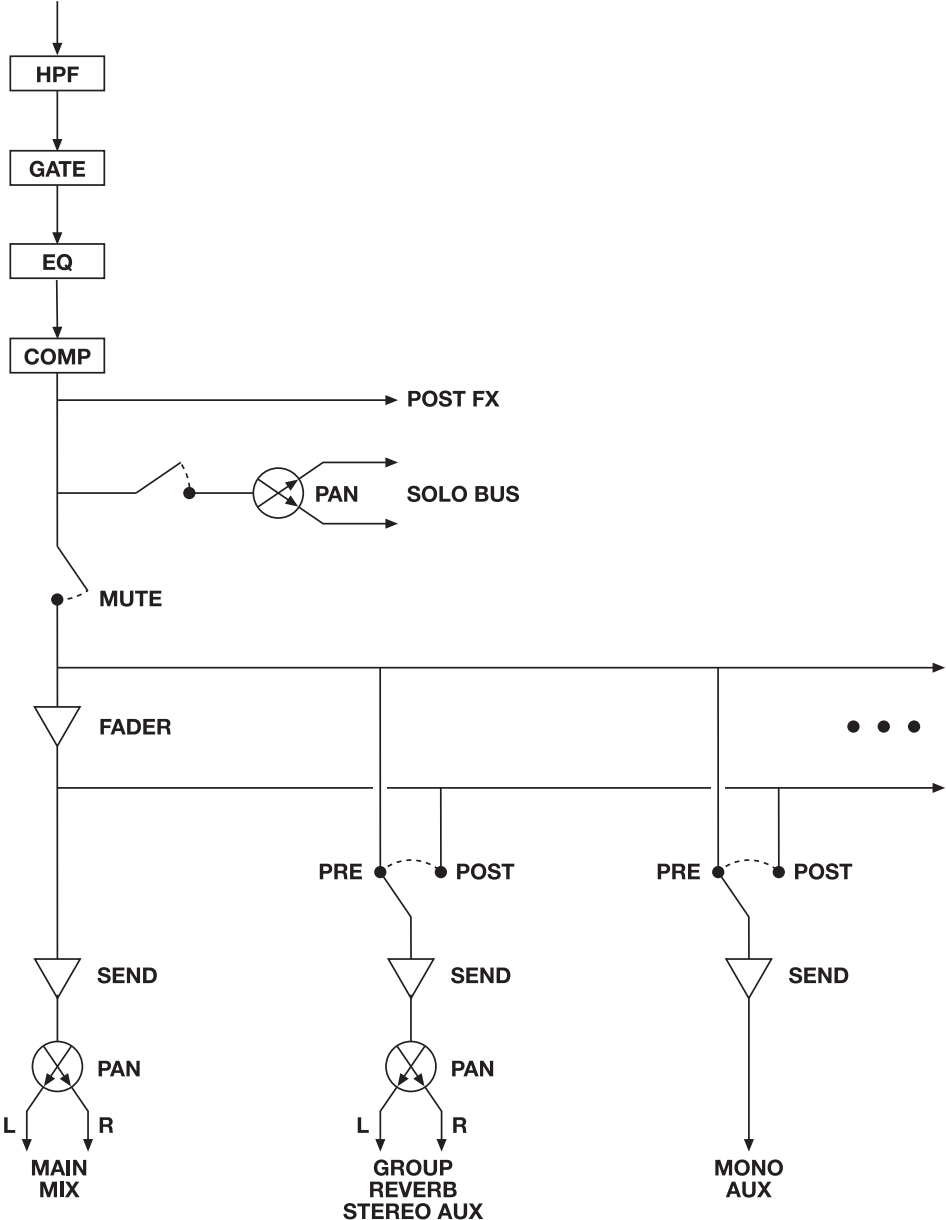

# STEREO INPUT CHANNEL

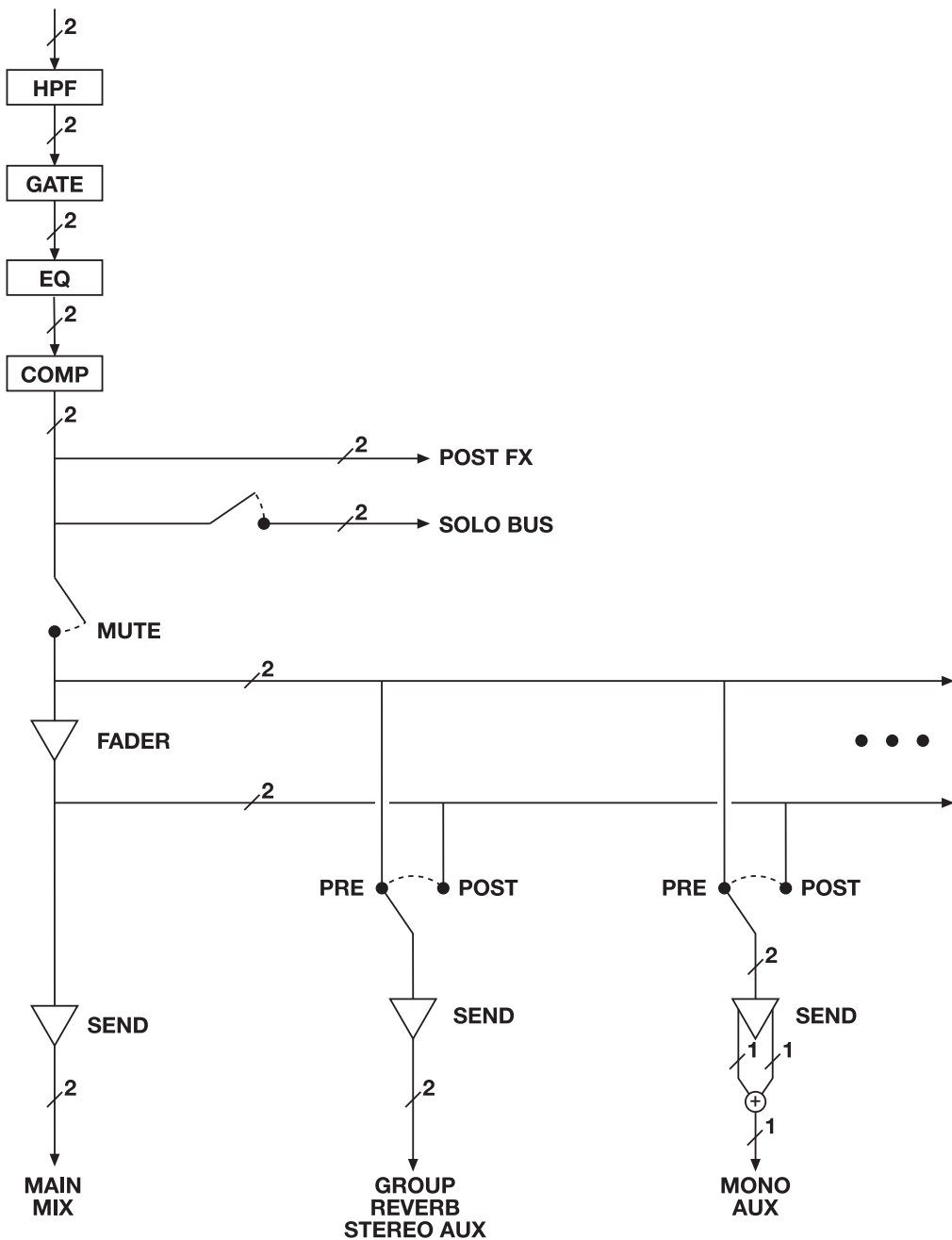

# GROUP BUS

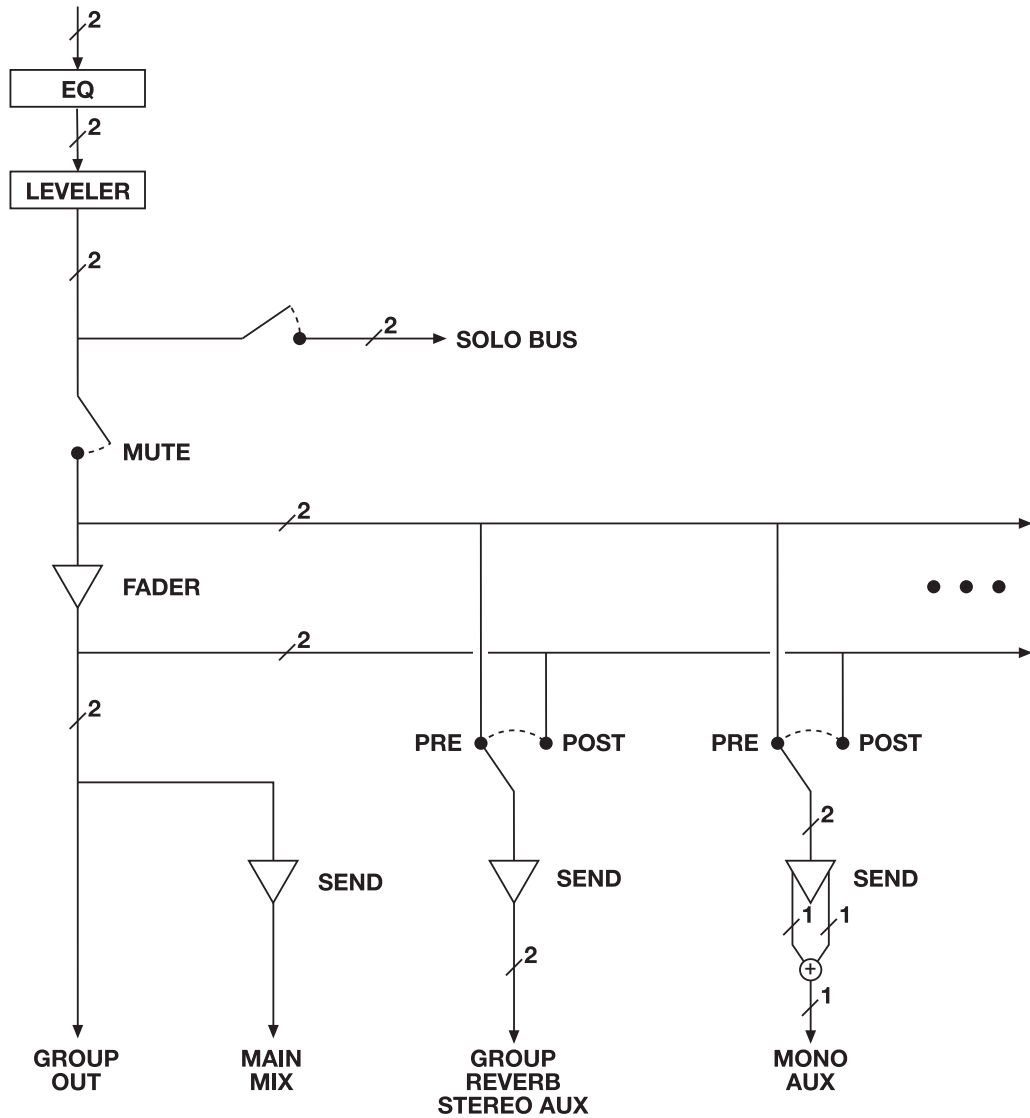

# MONITOR BUS

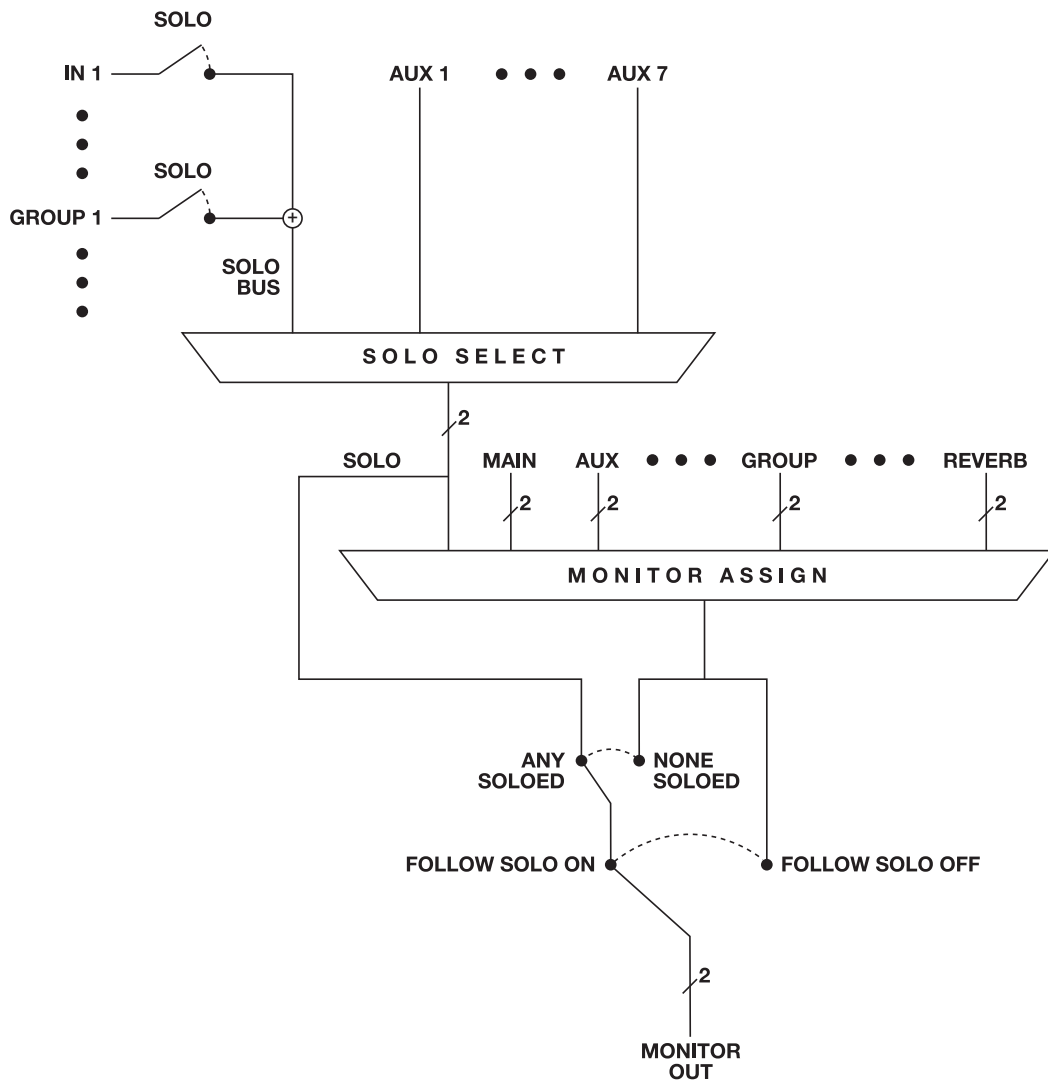

## APPENDIX D Updating Firmware

MOTU periodically posts firmware updates for the 828es. These updates may include bug fixes, enhancements and new features.

Updates are posted on MOTU's servers. If your computer or Wi-Fi device has access to the internet, the MOTU Pro Audio Control app notifies you as soon as an update is made available. Otherwise, you can check [motu.com/proaudio](http://motu.com/proaudio) periodically for the latest firmware update.

### A USB or network cable connection is required

Firmware updating requires either a USB or network cable connection to your computer. So before you begin, connect a USB cable from the 828es to your computer, or connect a standard CAT-5 or CAT-6 network cable from the network port on the 828es to one of the following:

- Your computer's network port (or a Thunderbolt-to-Ethernet adapter)
- Your home, studio, or office network (with internet access)
- An AVB port on a MOTU AVB switch (connected to your office network through the Ethernet port)

☛ Having both USB *and* Ethernet connected during the firmware update process is also fine.

You can update firmware with or without internet access. Both scenarios are explained below.

### Updating with internet access

You are now ready to update the firmware:

- 1 Launch the MOTU Pro Audio Control web app on your computer, iPad, or iPhone, as usual.
- 2 Go to the Device tab.
- 3 In the *New Update Available* banner (Figure D-1), click *More Info*.
- 4 After reviewing the list of enhancements, click OK to start the update.
- 5 Follow the on-screen instructions.
- 6 If you have a Mac, and you normally use USB or Thunderbolt to connect the 828es to your Mac, it is a good idea to disconnect the Ethernet cable after you complete the update, so that the Mac doesn't switch to Ethernet as the primary audio connection to the 828es (instead of USB or Thunderbolt).

### Updating off-line, without internet access

If the 828es (and the computer it is connected to) has no internet access, you can download a firmware update file from another computer that does have internet, and then use the file to update the 828es, as follows:

- 1 Download the firmware file from [motu.com/proaudio](http://motu.com/proaudio).

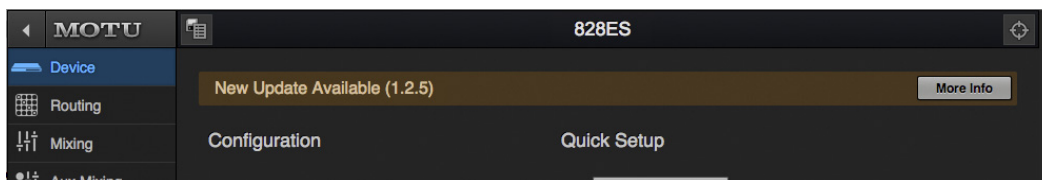

Figure D-1: The firmware update banner appears across the Device tab when your web host has internet access and MOTU posts an update.

- 2 Transfer the file to a computer with a USB or network cable connection to the 828es.
- 3 Launch the MOTU Pro Audio Control web app on the computer, as usual.
- 4 Go to the Device tab, scroll down to the bottom and click *Update from File*.
- 5 Locate the file on your hard drive and click OK to start the update.
- 6 Follow the on-screen instructions.
- 7 If you have a Mac, and you normally use USB or Thunderbolt to connect the 828es to your Mac, it is a good idea to disconnect the Ethernet cable after you complete the update, so that the Mac doesn't switch to Ethernet as the primary audio connection to the 828es (instead of USB or Thunderbolt).

### Updating multiple interfaces on a network

If you have two or more MOTU interfaces on a network, you can update their firmware all at once.

- 1 Go to the MOTU Discovery Settings menu.

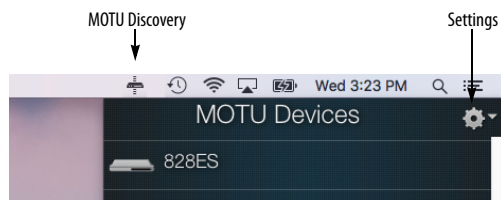

Figure D-2: MOTU Discovery Settings menu.

- 2 Choose *Firmware Updater > Open...*

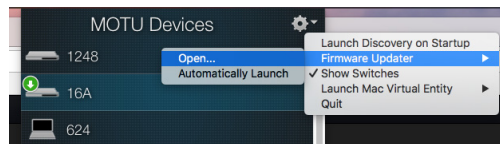

Figure D-3: Launching the Firmware Updater.

- 3 Connect Ethernet cables, if necessary, or click the *Update from File* option.
- 4 Click *Update All Interfaces Now*.

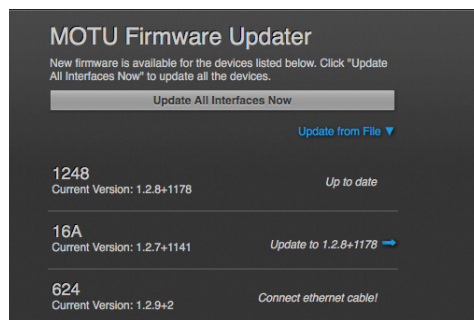

Figure D-4: Updating multiple interfaces in one operation.

### Viewing the latest firmware version information

You can confirm the firmware version at the bottom of the Device tab (Figure D-5).

System Information									
Manufacturer	Model	GUID	Firmware Version	UI Version	Hostname	Driver Version	IP Address	OSC UDP Port	
MOTU	828ES	0001f2ffe001169	1.0.0+d109	1.0.0	828ES	Mac 2.0.0+72782	192.168.3.117	53810	

Figure D-5: The currently installed firmware version is displayed at the bottom of the Device tab.

## APPENDIX E    **OSC Support**

*Open Sound Control* (OSC) is a protocol for communication among computers and other multimedia devices that is optimized for modern networking technology.

MOTU audio interfaces support OSC, which provides remote control of all device settings and mixer controls from any OSC-enabled controller.

For further details about remote control through OSC, along with complete documentation for the MOTU AVB OSC API, visit:

<http://www.motu.com/proaudio#avb-osc-support>





- +4dB analog input 44
- 10dB analog input 44
- 24-bit
  - optical 10, 25
- 2x SMUX mode 13, 45
- 828es
  - expansion 34
  - setup example 43
  - specifications 105
  - summary of features 23

## A

- Ableton Live 63, 64
- ADAT optical 10, 25
  - connecting 45
  - settings 13
- Analog inputs/outputs 10, 45
  - making connections to 44
- Apple
  - GarageBand 64
  - Logic Pro 64
- ASIO driver 64
- ASIO monitoring 65
- Attack
  - Compressor 72, 74
- Audio interface preset 53
- Audio Tools 79
- AudioDesk 26, 31, 63, 64
- Auto 74
- Auto (Makeup Gain) 74
- Aux Mix Target 17
- Aux Mixing tab 17
- AVB
  - audio interface operation 23, 34, 40
  - Ethernet explained 95
  - Input/Output Banks 13
  - networking 95–100
  - overview 95
  - Stream Connections 13
  - Stream Setup 13
  - streams (Routing tab) 15
  - Switch
    - setup 35, 39
- AVB menu item 58
- Avid
  - Pro Tools 64

## B

- Balanced analog 44
- Become Clock Master 12, 50
- Buffer Size 12, 30

## C

- CAT-5e/6 cables 34
- Check for Updates 14
- Chrome 11
- Class compliance 29
- Clear Password 14, 59
- Clock Mode 12, 59
- Clock mode 57
- Clock section (LCD) 58

- Clock source 46
- Coax 25
- Cockos Reaper 64
- Compressor effect 16, 73
- Computer Channel for LTC-to-MTC
  - Conversion 14
- Computer Setup 14
- Computer Volume Controls option 14
- Condenser mic input 44
- Configure IP 59
- Connecting multiple interfaces 34
- Control surface support (through OSC) 115
- Controller
  - connecting 46
- Converter mode
  - setup/example 56
- Core Audio driver 64
- Correlation Meter 90
- Cubase 63, 64
  - clock source 63
  - sample rate 63
- CueMix FX
  - Devices menu 79
  - installation 79
  - output jacks 10
- Customer
  - support 104

## D

- Device menu item 58
- Device tab 12, 13
- Devices menu 79
- Digital converter (see Optical converter)
- Digital Performer 63, 64
  - Direct hardware playthrough 65
- Dim 61
- Direct ASIO monitoring 65
- Direct hardware playthrough 65
- Discovery app 7, 31
- Driver installation 7, 11, 29
- Drivers
  - installing USB drivers 29
- DSP
  - effects 71
  - meter 77
  - resources 77
- DSP Usage 18, 77
- Dynamic mic 44

## E

- Effects 71
- Enable Jam Sync 14
- EQ 72
  - enabling 72
  - filter types 72
  - frequency 72
  - gain 72
  - Q 72
- Ethernet
  - connecting 39
- Ethernet interface operation 34, 40
- Expansion 34

## F

- Factory Defaults 59
- Firefox 11
- Firmware
  - version 14
- Firmware updates 12
- Follow Solo 16, 19
- Foot switch 26
  - connecting 46
  - jack 10
- Four-band EQ 72
- Frequency
  - EQ 72
- From Computer 15
- Front panel 57
  - menu navigation 58
  - metering 57

## G

- Gain
  - EQ 72
  - reduction 74
  - reduction (Leveler) 76
- GarageBand 63, 64
  - clock source 63
  - sample rate 63
- Gate effect 16, 72
- GR (gain reduction) 74
- Guitar
  - connecting 44

## H

- Headphone outputs 9
- Headphones
  - connecting 43
- High pass filter 71
- Host
  - Buffer Size 12, 30
  - Safety Offset 12, 31

## I

- ID knob/button 11, 12
- IEEE 802.1 95
- Input banks 13
- Input settings 12
- Inputs
  - analog 10
  - optical 10
  - prefader metering 18
- Installation
  - AVB audio interface 34, 40
  - iOS connection 33
  - network 35, 36
  - QuickStart Guide 7
  - software 29
  - Thunderbolt interface 33
  - two interfaces networked 34
  - USB connection 33
- Interface + mixer preset 54
- iOS operation 29, 33
- IP address 11, 14, 58

iPad  
QuickStart 7  
iPad/iPhone support 29

## J

Jam sync 14, 49

## K

Keyboard controller  
connecting 46

## L

Latency 12, 30, 64, 66  
Launch Mac Virtual Entity 40  
LCD  
menu 58  
Leveller 16, 75  
Limit button 76  
Live 64  
Live recording with monitor mixing preset  
55  
Lock button 15  
Logic Pro 64  
Logic Pro/Express 63  
clock source 63  
sample rate 63  
LTC  
Input Source 14  
Setup 48  
to MTC conversion 69

## M

Mac OS X 63  
input and output names 69  
system requirements 27  
Mac Virtual Entity 40  
Main outs  
front panel volume control 44  
jacks 10  
making connections to 44  
Makeup Gain 74  
Makeup gain 76  
Meters 57, 58  
overview 59  
prefader 18  
Mic inputs  
preamp gain/pad/48V 9  
Mic/guitar inputs 44  
Mic/instrument inputs  
overview 23  
MIDI  
activity indicators 57  
MIDI Thru 59  
MIDI Time Code 14, 69  
Mixer  
accessing 16  
aux bus 20  
connecting 43  
effects 71  
group bus 21  
input channel strip 18

main mix channel strip 19  
Monitor channel strip 19  
overview 16  
Reverb bus 21  
schematics 109  
Setup 13  
stand-alone operation 71  
Mixing tab 16  
Monitor  
A/B output assignments 59  
A/B select 59  
controls 59  
volume control 60  
Monitoring  
thru main outs 44  
Mono button 60  
MOTU  
Audio Tools 79  
AudioDesk 64  
AVB Installer 29  
AVB Switch  
setup 35, 39  
Digital Performer 64  
Discovery app 7, 11, 31, 114  
Pro Audio ASIO driver 64  
Pro Audio Control web app 7, 11, 21  
Aux Mixing tab 17  
Device tab 12, 13  
Mixing tab 16  
Routing tab 15  
Pro Audio Installer 7, 11  
Pro Audio WebUI Setup 11, 31  
MTC 14, 69  
Mute button 60

## N

NET ID button 61  
Network menu item 58  
Networking 95–100  
installation 35, 36  
Nuendo 63, 64  
clock source 63  
sample rate 63

## O

Optical 59  
connectors 10, 45  
meters 57  
overview 25  
S/PDIF 45  
Optical Converter preset 56  
setup/example 56  
Optical setup 13  
Optimization 66  
OS X audio software  
clock source 63  
sample rate 63  
OSC support 115  
Oscilloscope 82  
Output banks 13  
Output settings 12  
Outputs  
analog 10  
optical 10

## P

Packing list 27  
Pad 44  
Password protection 14  
Patch thru  
latency 66  
Pedal 26  
jack 10  
Pedal A 46  
Pedal B/LRC 46  
Performance 66  
Phantom power 44  
Phase Analysis 90  
Phase-lock 47  
Phone outputs 9  
Power switch 9  
PRE button 18  
PRE switch 16  
PreDelay 76  
Prefader button 17  
Presets 7, 12  
Mixer tab 16  
overview 53  
Routing tab 15  
Presets menu 59  
Pro Audio Control web app 7, 11–21  
Aux Mixing tab 17  
Device tab 12, 13  
Mixing tab 16  
Routing tab 15  
Pro Tools 63, 64  
Processing 71  
Punch in/out 26

## Q

Q 72  
Quick Setup window 7  
QuickStart Guide 7

## R

Ratio  
Compressor 73  
Reaper 63, 64  
Reason 63  
Propellerhead Reason 64  
Reboot 14  
Registration 27  
Release  
Compressor 72, 74  
Remote control (through OSC) 115  
Restore Factory Presets 14  
Reverb 76–77  
design section 77  
enabling/disabling 76  
predelay 76  
routing to/from 76  
time 76, 77  
width 77

RMS mode 74  
Routing tab 15

## S

S/PDIF 25  
    connection 45  
    meters 57  
    optical 10, 25, 45  
    sync 47  
Safari 11  
Sample Rate 59  
Sample rate 12, 57  
    conversion 45  
Samplers  
    connecting 43  
SC button 19  
Schematics 109  
Serial/UID 58  
Set password 14  
SMPTE sync 48  
SMPTE time code 14  
Software  
    installation 29  
Software installer 7, 11, 29  
Solo bus 19  
Solo Clear button 18  
SONAR 63  
Sound module  
    connecting 46  
Soundtrack Pro  
    clock source 63  
    sample rate 63  
SRC 45  
Stage I/O preset 55  
Stage monitors  
    connecting 43  
Stand-alone mixer preset 54

Stand-alone operation 57, 61  
Standard (optical setting) 45  
Steinberg  
    Cubase 64  
    Nuendo 64  
Sticky 61  
Stop Jam Sync 14  
Studio setup (example) 43  
Synchronization 46  
    Become Clock Master 50  
    SMPTE time code 48  
Synths  
    connecting 43  
System Information 14  
System requirements  
    minimum 27  
    recommended computer 27

## T

Talk button 61  
Talkback 60–61  
    dim 61  
    settings 61  
    setup 60  
    sticky 61  
Technical support 104  
Threshold  
    Compressor 73  
Thru (word clock) 48  
Thunderbolt 33  
    connector 10  
Time code  
    settings 57  
Time code sync 14, 48  
Time Sensitive Networking (TSN) 24, 95  
To Computer 15  
TOSLink 10, 13, 25, 45

Trim 44  
Troubleshooting 103  
TRS analog inputs/outputs 45  
TRS connectors 44  
TSN 24, 95  
Type II (Legacy) optical setting 45

## U

Unbalanced analog 44  
Update From File 14, 114  
USB  
    class compliance 29  
    installing drivers 29

## V

Version menu item 59  
View Personal Mix 17

## W

Wave driver 64  
WDM (Wave) Driver 30  
Width  
    reverb 77  
Wi-Fi  
    setup 39  
Windows  
    shortcut 31  
    system requirements 27  
    WDM (Wave) driver 30  
Word clock 10, 25, 47  
    Thru 48

## X

X-Y Plot 87

