

User's Guide



Fireface UC

Portable USB Audio at its best!

DVD
24 Bit / 192 kHz ✓ *ready*

TotalMix™



SyncAlign™

ZLM™

SyncCheck™

SteadyClock™



USB 2.0 Digital I/O System
8 + 8 + 2 Channels Analog / ADAT / SPDIF Interface
24 Bit / 192 kHz Digital Audio
36 x 18 Matrix Router
2 x MIDI I/O
Stand-Alone Operation
MIDI Remote Control
Stand-Alone MIDI Controlled Operation

► **General**

1	Introduction	6
2	Package Contents	6
3	System Requirements	6
4	Brief Description and Characteristics	6
5	First Usage - Quick Start	
5.1	Connectors and Front Panel	7
5.2	Quick Start	8

► **Installation and Operation - Windows**

6	Hardware Installation	10
7	Driver and Firmware	
7.1	Driver Installation	10
7.2	Driver Update	11
7.3	De-installing the Drivers.....	11
7.4	Firmware Update	11
8	Configuring the Fireface UC	
8.1	Settings Dialog – General	12
8.2	Settings Dialog – Pitch	14
8.3	Settings Dialog – Gain	15
8.4	Settings Dialog – LTC	15
9	Operation and Usage	
9.1	Playback.....	16
9.2	DVD Playback (AC-3 / DTS).....	17
9.3	Notes on WDM.....	18
9.4	Channel Count under WDM.....	19
9.5	Multi-client Operation	19
9.6	Analog Recording.....	20
9.7	Digital Recording.....	20
9.8	Clock Modes - Synchronization	21
10	Operation under ASIO	
10.1	General	22
10.2	Channel Count under ASIO	22
10.3	Known Problems	23
11	Using more than one Fireface	23
12	DIGICheck Windows	24
13	Hotline – Troubleshooting	25

► **Installation and Operation - Mac OS X**

14	Hardware Installation	28
15	Driver and Firmware	
15.1	Driver Installation	28
15.2	Driver Update	29
15.3	Firmware Update.....	29
16	Configuring the Fireface	
16.1	Settings Dialog – General	30
16.2	Clock Modes - Synchronization	32
17	Mac OS X FAQ	
17.1	Round about Driver Installation.....	33
17.2	MIDI doesn't work	33
17.3	Repairing Disk Permissions	33
17.4	Supported Sample Rates.....	33
17.5	Channel Count under Core Audio.....	34
17.6	Various Information	34

18	Using more than one Fireface	35
19	DIGICheck Mac	35
20	Hotline – Troubleshooting	36

▶ **Stand-Alone Operation, Connections**

21	Stand-alone Operation	
21.1	Front Panel Operation	38
21.2	8-channel AD/DA-Converter	39
21.3	2-channel Mic Preamp	39
21.4	Monitor Mixer	39
21.5	Digital Format Converter	39
21.6	Analog/digital Routing Matrix	39
22	Analog Inputs	
22.1	Line Rear	40
22.2	Microphone / Line Front	40
22.3	Instrument / Line Front	41
23	Analog Outputs	
23.1	Line	42
23.2	Phones (7/8)	42
24	Digital Connections	
24.1	ADAT	43
24.2	SPDIF	43
24.3	MIDI	44
25	Word Clock	
25.1	Word Clock Input and Output	45
25.2	Technical Description and Background	46
25.3	Cables and Termination	47
25.4	General Operation	47

▶ **TotalMix FX**

26	TotalMix: Routing and Monitoring	
26.1	Overview	50
26.2	The User Interface	52
26.3	The Channel	53
	Settings	55
26.4	Section Control Room	56
26.5	The Control Strip	57
	View Options	58
	Snapshots - Groups	59
26.6	Preferences	60
26.7	Settings	61
26.8	Hotkeys and Usage	62
26.9	Menu Options	63
27	The Matrix	
27.1	Overview	64
27.2	The User Interface	64
27.3	Usage	64
28	Tips and Tricks	
28.1	ASIO Direct Monitoring (Windows)	65
28.2	Copy a Submix	65
28.3	Delete a Submix	65
28.4	Doubling the Output Signal	65
28.5	Recording a Submix - Loopback	66
28.6	MS Processing	67

29	MIDI Remote Control	
29.1	Overview	68
29.2	Mapping	68
29.3	Setup	69
29.4	Operation	69
29.5	MIDI Control	70
29.6	Loopback Detection	70
29.7	Stand-Alone MIDI Control	72

▶ **Technical Reference**

30	Technical Specifications	
30.1	Analog	74
30.2	MIDI	75
30.3	Digital	75
30.4	Digital Inputs	75
30.5	Digital Outputs	76
30.6	General	76
31	Technical Background	
31.1	Lock and SyncCheck	77
31.2	Latency and Monitoring	78
31.3	USB Audio	79
31.4	DS – Double Speed	80
31.5	QS – Quad Speed	80
31.6	AES/EBU – SPDIF	81
31.7	Noise Level in DS / QS Mode	82
31.8	SteadyClock	82
32	Diagrams	
32.1	Block Diagram Fireface UC	83
32.2	Connector Pinouts	84

▶ **Miscellaneous**

33	Accessories	86
34	Warranty	86
35	Appendix	87
36	Declaration of Conformity	88

User's Guide



Fireface UC

▶ **General**

1. Introduction

Thank you for choosing the Fireface UC. This unique audio system is capable of transferring analog and digital audio data directly to a computer from practically any source. The latest Plug and Play technology guarantees a simple installation, even for the inexperienced user. The numerous unique features and well thought-out configuration dialog puts the Fireface UC at the very top of the range of computer-based audio interfaces.

The package contains drivers for Windows XP / Vista / 7 and Mac OS X x86 (Intel).

Our high-performance philosophy guarantees maximum system performance by executing as many functions as possible not in the driver (i.e. the CPU), but directly within the audio hardware.

2. Package Contents

Please check that your Fireface UC package contains each of the following:

- Fireface UC
- Cable USB 2.0, 1.8 m (6 ft)
- MIDI breakout cable
- Power supply
- Manual
- RME Driver CD
- 1 optical cable (TOSLINK), 2 m (6.6 ft)

3. System Requirements

- Windows XP SP or up, Intel Mac OS X (10.5 or up)
- 1 USB 2.0 port
- Computer with at least Pentium Core 2 Duo CPU

4. Brief Description and Characteristics

- Enhanced Mixed Mode: Analog, ADAT and SPDIF I/O simultaneously usable
- Buffer sizes/latencies from 48 up to 8192 samples selectable
- All settings can be changed in real-time
- 4 channels 96 kHz/24 bit Record/Playback via ADAT optical (S/MUX)
- Clock modes slave and master
- Automatic and intelligent master/slave clock control
- Unsurpassed Bitclock PLL (audio synchronization) in ADAT mode
- SteadyClock: Jitter-immune, super-stable digital clock
- DDS technology for free setting of the sample rate
- TotalMix for latency-free submixes and perfect ASIO Direct Monitoring
- TotalMix: 648 channel mixer with 42 bit internal resolution
- SyncAlign guarantees sample aligned and never swapping channels
- SyncCheck tests and reports the synchronization status of input signals
- Word clock input and output
- 2 x MIDI I/O, 32 channels high-speed MIDI
- 1 x Hi-power headphone output
- DIGICheck DSP: Level meter in hardware, peak- and RMS calculation

5. First Usage – Quick Start

5.1 Connectors and Front Panel

The front of the Fireface UC features instrument, microphone and line inputs, a stereo line/headphone output, a rotary encoder with 7 segment display, and several status and MIDI LEDs.

The Neutrik combo jacks of the **Mic/Line** inputs can be used via XLR and 1/4" TRS plugs. Both inputs display overload (CLIP), signal presence (SIG) and phantom power (48V) via green, red and yellow LEDs.



Inputs 3/4, **INST/LINE**, accept both a balanced line signal as well as an unbalanced instrument signal via 1/4" TRS plug.

The **rotary encoder** serves to set the input and output levels directly at the unit. This is not only useful in stand-alone operation, but for example also when setting up the monitor volume. Pushing the knob changes the encoder from CHANNEL to LEVEL mode and back. Pushing the knob for more than a second activates either the single channel or stereo setup mode.

The **State LEDs** (WC, SPDIF, ADAT) indicate a valid input signal separately for each digital input. Additionally, RME's exclusive *SyncCheck* indicates if one of these inputs is locked, but not synchronous to the others, in which case the LED will flash. See also chapter 9.8/16.2, Clock Modes - Synchronization.

The red **HOST** LED lights up when the Fireface UC has been switched on. It operates as error LED, in case the USB connection hasn't been initialised yet, or has been interrupted (error, cable not connected etc.).

The yellow **MIDI** LEDs indicate MIDI data received or sent, separately for both inputs and outputs.



Phones is a low impedance line output of highest quality. It provides a sufficient and undistorted volume even when used with headphones.

The rear panel of the Fireface UC features four analog inputs, six analog outputs, the power socket, and all digital inputs and outputs.

SPDIF I/O coaxial (RCA): AES/EBU compatible. The Fireface UC accepts the commonly used digital audio formats, SPDIF as well as AES/EBU.

ADAT I/O (TOSLINK): The unit automatically detects SPDIF or ADAT input signals. The optical output can operate as ADAT or SPDIF output, depending on the current setting in the Settings dialog.



Word Clock I/O (BNC): A push switch activates internal termination (75 Ohms). When termination is activated the yellow LED beside the switch lights up.

MIDI I/O: Provides two MIDI inputs and outputs via the included breakout cable.

USB 2.0: USB socket for connection to the computer.

POWER (switch): Turns the Fireface UC on and off.

Socket for power connection. The included hi-performance switch mode power supply makes the Fireface operate in the range of 100V to 240V AC. It is short-circuit-proof, has an integrated line-filter, is fully regulated against voltage fluctuations, and suppresses mains interference.



5.2 Quick Start

After the driver installation (chapter 7 / 15) connect the TRS jacks or the XLR jacks with the analog signal source. The input sensitivity of the rear inputs can be changed in the Settings dialog (Gain/Level), assuring the highest signal to noise ratio will be achieved. Try to achieve an optimum input level by adjusting the source itself. Raise the source's output level until the peak level meters in TotalMix reach about -3 dB.

The analog line inputs of the Fireface UC can be used with $+4$ dBu and -10 dBV signals. The electronic input stage can handle balanced (XLR, TRS jacks) and unbalanced (TS jacks) input signals correctly.

The front's inputs signal level can be optimized using the Fireface's rotary encoder. A Signal LED and a Clip LED help to find the correct level adjustment.

The Fireface's digital outputs provide SPDIF (AES/EBU compatible) and ADAT optical signals at the corresponding ports.

On the analog playback side (the DA side), a coarse adjustment of the analog output level at the rear jacks is available in the Settings dialog (Gain/Level/Line Out).

The output signal of channels 7/8 is available on the front. Their output level can be set using the rotary encoder. This output is a very low impedance type, which can also be used to connect headphones.

The Fireface UC remembers all settings, and loads these automatically when switched on. With this, the Fireface UC can be used stand-alone after setting it up accordingly, replacing lots of dedicated devices (see chapter 21).

User's Guide



Fireface UC

▶ Installation and Operation - Windows

6. Hardware Installation

- Connect the power supply to the Fireface and then to any suitable power outlet. Power-on the Fireface with the rear power switch.
- Check the correct firmware version by a double click on the rotary encoder button. The display **PC** means Windows, the display **AP** means Mac. The double click automatically switches between both versions. Note: a change of state is only possible when the unit is not connected to the computer.
- Connect computer and Fireface using the supplied USB cable.
- Windows detects the new hardware as **Fireface UC Win (serial number)** and asks for drivers.

7. Driver and Firmware

7.1 Driver Installation

After the Fireface has been recognized, (see 6. Hardware Installation) the hardware assistant finds a **Fireface UC Win (serial number)**. Please note the **Win**. If **Mac** is displayed the unit has to be disconnected from the computer and its firmware has to be changed to **Win** (see above) prior to installing the drivers.

Insert the RME Driver CD into your CD-ROM drive, and follow further instructions which appear on your computer screen. The driver files are located in the directory **\Fireface UC Win** on the RME Driver CD.

Windows now installs the driver of the Fireface UC and registers it as a new audio device in the system. After a reboot, the symbols of mixer and Settings dialog will appear in the task bar. The red Host error LED extinguishes.



In case the Hardware Wizard does not show up automatically after connecting the Fireface, do not attempt to install the drivers manually! An installation of drivers for non-recognized hardware will cause a blue screen when booting Windows!

In **Windows 7** Microsoft removed the automatic start of the Driver Software Update dialog. Therefore this dialog has to be started manually after the failed driver installation. Hit the Win key, type 'Device Manager', start the Device Manager by selecting it from the list and hit Enter.

The device is shown with a yellow warning symbol. Usually it is already found in the correct category, Sound, Video and Game Controller (Plug & Play detects a multimedia device). Right click on the device and select 'Update Driver Software' from the context menu.

The dialog *Update Driver Software* appears. Now follow the instructions given below.

Possible reasons why a Fireface is not found automatically:

- The USB port is not active in the system (check the Device Manager)
- The USB cable is not, or not correctly inserted into the socket
- No power. After switching the Fireface on, at least the 7 segment display has to be lit.

7.2 Driver Update

When facing problems with the automatic driver update, the user-driven way of driver installation will work.

Under >Control Panel /System /Device Manager /Sound, Video and Game Controllers /RME Fireface UC/Properties /Driver< you'll find the 'Update Driver' button.

XP: Select '**Install from a list or specific location (advanced)**', click '**Next**', select '**Don't search I will choose the driver to install**', click '**Next**', then '**Have Disk**'. Now point to the driver update's directory.

Vista/7: Select '**Browse my computer for driver software**', then '**Let me pick from a list of device drivers from my computer**', then '**Have Disk**'. Now point to the driver update's directory.

This method also allows for the installation of older drivers than the currently installed ones.

7.3 De-installing the Drivers

A de-installation of the driver files is not necessary – and not supported by Windows anyway. Thanks to full Plug & Play support, the driver files will not be loaded after the hardware has been removed. If desired these files can then be deleted manually.

Unfortunately Windows Plug & Play methods do not cover the additional autorun entries of TotalMix, the Settings dialog, and the registration of the ASIO driver. These entries can be removed from the registry by a software de-installation request. This request can be found (like all de-installation entries) in *Control Panel, Software*. Click on the entry 'RME Fireface USB'.

7.4 Firmware Update

The Flash Update Tool updates the firmware of the Fireface UC to the latest version. It requires an already installed driver.

Start the program `fut_usb.exe`. The Flash Update Tool displays the current revision of the Fireface UC's firmware, and whether it needs an update or not. If so, then simply press the 'Update' button. A progress bar will indicate when the flash process is finished (Verify Ok).

A reboot of the computer is not necessary.

When the update fails (status: failure), the unit's Safety BIOS will be used from the next boot on, the unit stays fully functional. The flash process should then be tried again.

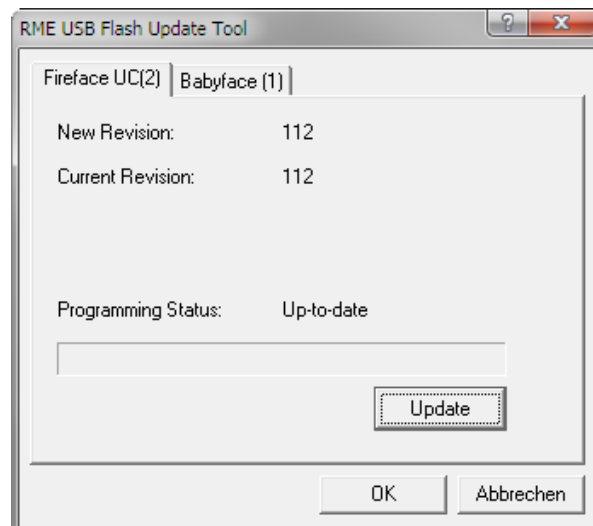

The Safety BIOS can also be activated manually: Push the rotary encoder button while switching on the unit. This method is also useful to temporarily deactivate a newer firmware. With pressed button the older version of the firmware will be loaded.

8. Configuring the Fireface

8.1 Settings Dialog - General

Configuration of the Fireface UC is done via its own settings dialog. The panel 'Settings' can be opened:

- by clicking on the fire symbol in the Task Bar's notification area

The mixer of the Fireface UC (TotalMix) can be opened:

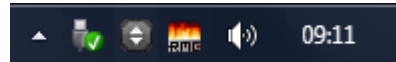

- by clicking on the mixer icon in the Task Bar's notification area

The hardware of the Fireface UC offers a number of helpful, well thought-of practical functions and options which affect how the card operates - it can be configured to suit many different requirements. The following is available in the 'Settings' dialog:

- Latency
- Configuration of digital I/Os
- Current sample rate
- Synchronization behaviour
- State of input and output
- Level of analog I/Os

Any changes made in the Settings dialog are applied immediately - confirmation (e.g. by clicking on OK or exiting the dialog) is not required.

However, settings should not be changed during playback or record if it can be avoided, as this can cause unwanted noises.

Also, please note that even in 'Stop' mode, several programs keep the recording and playback devices open, which means that any new settings might not be applied immediately.

The status displays at the bottom of the dialog box give precise information about the current status of the system, and the status of all digital signals.

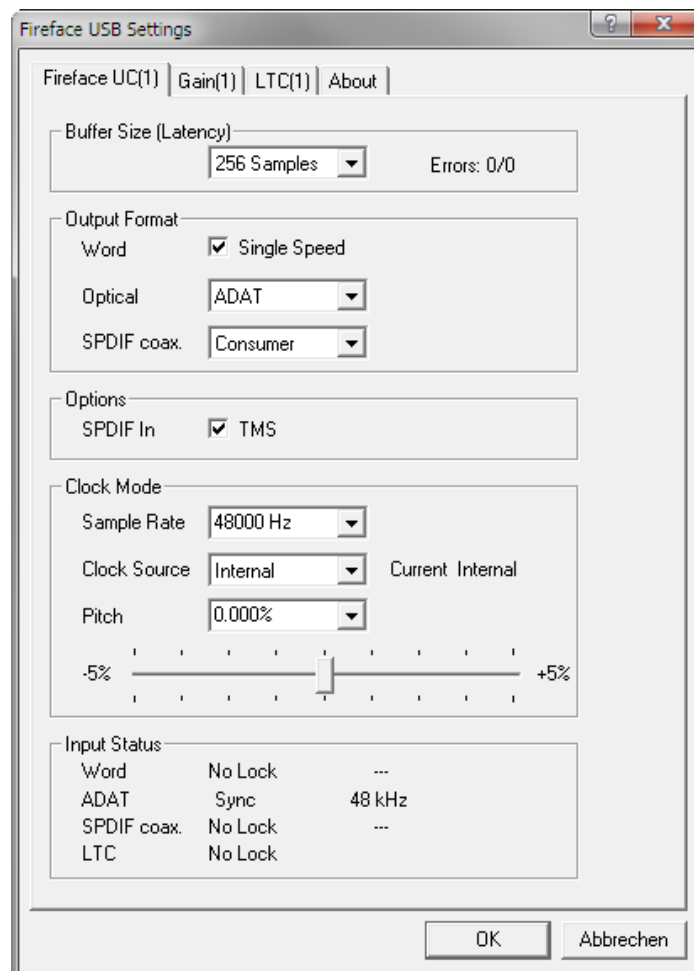

Buffer Size

The setting *Buffer Size* determines the latency between incoming and outgoing ASIO and WDM data, as well as affecting system stability (see chapter 13/14).

The string **Errors** does not refer to buffer errors, but USB transmission errors. The display will be reset on any start of a playback/record. More information can be found in chapter 35.3.

Output Format

Word

The word clock output signal usually equals the current sample rate. Selecting *Single Speed* causes the output signal to always stay within the range of 32 kHz to 48 kHz. So at 96 kHz and 192 kHz sample rate, the output word clock is 48 kHz.

Optical

The optical TOSLINK output can operate as ADAT or SPDIF output. The Channel Status is fixed to Consumer state.

Note: The optical input detects the incoming format automatically.

SPDIF coax.

The coaxial SPDIF output can have the Channel Status Consumer or Professional. For further details please refer to chapter 24.2.

Options

SPDIF In - TMS

TMS activates the transmission of Channel Status data and Track Marker information from the SPDIF input signal.

Clock Mode

Sample Rate

Sets the currently used sample rate. Offers a central and comfortable way of configuring the sample rate of all WDM devices to the same value, as since Vista this is no longer supported to be done by the audio program. However, an ASIO program can still set the sample rate by itself.

At ongoing record/playback the selection is greyed out, so no change is possible.

Clock Source

The unit can be configured to use its own clock (Internal = Master), or one of the input signals (Word, Optical, SPDIF coax., LTC = Slave). If the selected source isn't available, the unit will change to the next available one (AutoSync). If none is available then the internal clock is used. The current clock source is displayed to the right.

Pitch

More information on Pitch is available in chapter 8.2.

Input Status

Indicates for each input (Word, optical, SPDIF coax.) whether there is a valid signal (Lock, No Lock), or if there is a valid *and* synchronous signal (Sync). The second row shows the sample frequency measured by the hardware. In *Clock Mode* the clock reference is shown. See also chapter 31.1.

The **About** tab includes information about the current driver version as well as the current firmware version of the Fireface UC.

8.2 Settings Dialog - Pitch

Usually soundcards and audio interfaces generate their internal clock (master mode) by a quartz. Therefore the internal clock can be set to 44.1 kHz or 48 kHz, but not to a value in between. SteadyClock, RME's sensational Low Jitter Clock System, is based on a Direct Digital Synthesizer (DDS). This superior circuitry can generate nearly any frequency with highest precision.

DDS has been implemented into the Fireface with regard to the needs of professional video applications, as well as to maximum flexibility. The section Pitch includes both a list of typical video frequencies (so called pull up/pull down at 0.1% and 4%) and a fader to freely change the basic sample rate in steps of 1 Hz (!) over a range of +/- 5%.



The Pitch function requires the Fireface to be in clock mode Master! The frequency setting will only be applied to this one specific Fireface!



Changing the sample rate during record/playback often results in a loss of audio, or brings up warning messages of the audio software. Therefore the desired sample rate should be set at least coarsely before starting the software.

Coarse

Coarse modification in steps of 50 Hz is done by clicking with the mouse to the left and right of the fader knob.

Fine

Fine modification in steps of 1 Hz is done by using the left/right cursor keys.

Reset

Ctrl key plus left mouse click.

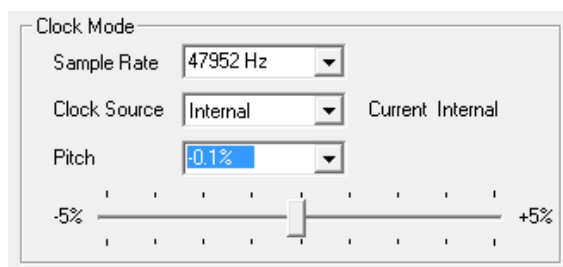

Application examples

Pitch allows for a simultaneous change of speed and tune during record and playback. From alignment to other sources up to creative effects – everything is possible.

Pitch enables you to intentionally de-tune the complete DAW. This way, the DAW can match instruments which have a wrong or unchangeable tuning.

Pitch allows for the change of the sample rate of all WDM devices at the same time. Since Vista this is no longer possible via the audio program, thus requires a manual reconfiguration of all WDM devices. Changing the sample rate from the Settings dialog solves this problem. As the change within the system requires some time, record/playback should not be started immediately, but not before 5 seconds after a change.

Tip: the current CPU load can be used to determine if the audio subsystem has finished the re-configuration.

8.3 Settings Dialog – Gain

The tab Gain has options to change the reference levels of some channels. The gain of channels 1 to 4 is adjustable per channel within the settings panel (click the wrench symbol) of the respective input channel in TotalMix FX.

Level

Line In

Defines the reference level of the rear analog inputs 5-8. The available settings are -10 dBV, +4 dBu and LoGain.

Line Out

Defines the reference level of the rear analog outputs 1-6. The available settings are -10 dBV, +4 dBu and HiGain.

Phones

Defines the reference level of the analog outputs 7/8. The available settings are -10 dBV, +4 dBu and HiGain.

8.4 Settings Dialog - LTC

The Fireface UC can extract position information as APP (ASIO Positioning Protocol) from Timecode (LTC, SMPTE) received at the analog input 4.

A detected Timecode is shown as time information in the **LTC In** field. The analog input signal needs a specific level: slowly reduce the level until the display stumbles or completely fails. Then increase the level by 10 dB.

The field **Input State** will show further details of the Timecode.

Basically Timecode can also be used as clock source. However, the calculation of the position information is less precise then. Recommended is a clocking of the Fireface UC with a clock signal (for example Word) directly from the device that sends the Timecode.

9. Operation and Usage

9.1 Playback

In the audio application being used, Fireface must be selected as output device. This can often be found in the *Options*, *Preferences* or *Settings* menus as *Playback Device*, *Audio Devices*, *Audio* etc.

We recommend switching all system sounds off (via >*Control Panel /Sound*<). Also Fireface should not be the *Preferred Device* for playback, as this could cause loss of synchronization and unwanted noises. If you feel you cannot do without system sounds, you should consider using the on-board sound device or buying a cheap Blaster clone and select this as *Preferred Device* in >*Control Panel /Multimedia /Audio*< or >*Control Panel /Sound /Playback*<.

The screenshot shows a typical configuration dialog. After selecting a device, audio data is sent to an analog or digital (ADAT / SPDIF) port, depending on which has been selected as playback device.

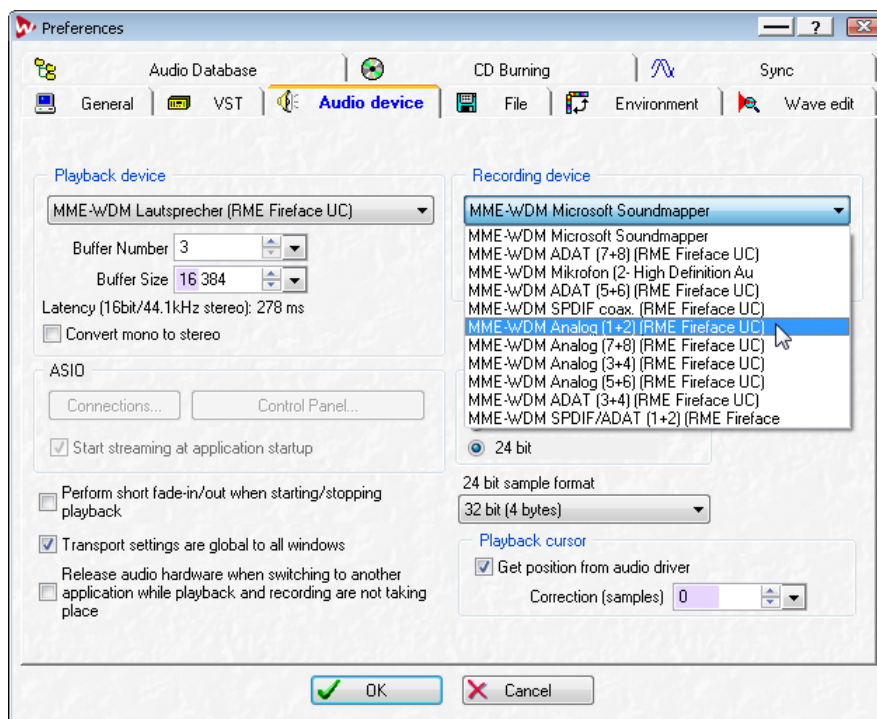

Increasing the number and/or size of audio buffers may prevent the audio signal from breaking up, but also increases latency i.e. output is delayed. For synchronized playback of audio and MIDI (or similar), be sure to activate the checkbox 'Get position from audio driver'.

Note on Windows Vista/7:

Since Vista the audio application can no longer control the sample rate under WDM. Instead the user has to work himself through numerous settings (up to 32 with a MAD1 card!), and to set the sample rate to the same value per stereo device.

Therefore the driver of the Fireface UC includes a workaround: the sample rate can be set globally for all WDM devices within the Settings dialog, see chapter 8.1.

9.2 DVD-Playback (AC-3/DTS)

AC-3 / DTS

When using popular DVD software players like *WinDVD* and *PowerDVD*, their audio data stream can be sent to any AC-3/DTS capable receiver using the Fireface's SPDIF outputs. For this to work, the WDM SPDIF device of the Fireface UC has to be selected in *>Control Panel/ Sounds and Multimedia/ Audio<* or *>Control Panel/ Sound/Playback<*. Also check 'use preferred device only'.

The DVD software's audio properties now show the options 'SPDIF Out' or similar. When selecting it, the software will transfer the non-decoded digital multichannel data stream to the Fireface.

This 'SPDIF' signal sounds like chopped noise at highest level. Therefore the Fireface automatically sets the non-audio bit within the digital data stream, to prevent most SPDIF receivers from accepting the signal, and to prevent any attached equipment from being damaged.

Multichannel

PowerDVD and WinDVD can also operate as software decoder, sending a DVD's multichannel data stream directly to the analog outputs of the Fireface. All modes are supported, from 2 to 8 channels, at 16 bit resolution and up to 192 kHz sample rate. For this to work select the WDM playback device 'Loudspeaker' of the Fireface UC in

XP: *>Control Panel/ Sounds and Multimedia/ Audio<*, and check 'Use only default devices'. Additionally the loudspeaker setup, found under *>Volume/ Speaker Settings/ Advanced<* has to be changed from *Stereo* to *5.1 Surround*.

Vista/7: *>Control Panel/ Sound/ Playback <* as 'Standard'. Additionally the loudspeaker setup, found under *>Configuration<*, has to be changed from *Stereo* to *5.1 Surround*.

PowerDVD's and WinDVD's audio properties now list several multichannel modes. If one of these is selected, the software sends the decoded analog multichannel data to the Fireface. TotalMix can then be used to play back via any desired output channels.

The typical channel assignment for surround playback is:

- 1 - Left
- 2 - Right
- 3 - Center
- 4 - LFE (Low Frequency Effects)
- 5 - SL (Surround Left)
- 6 - SR (Surround Right)

Note 1: Selecting the Fireface to be used as system playback device is against our recommendations, as professional interfaces should not be disturbed by system events. Make sure to re-assign the selection after usage or to disable any system sounds (tab *Sounds*, scheme 'No audio').

Note 2: The DVD player will be synced backwards from the Fireface. This means when using *AutoSync* and/or word clock, the playback speed and pitch follows the incoming clock signal.

9.3 Notes on WDM

The driver offers one WDM streaming device per stereo pair, like **ADAT 1+2 (Fireface UC)**. WDM Streaming is Microsoft's current driver and audio system, directly embedded into the operating system. WDM Streaming is hardly usable for professional music purposes, as all data is processed by the so called Kernel Mixer, causing a latency of at least 30 ms. Additionally, WDM can perform sample rate conversions unnoticed, cause offsets between record and playback data, block channels unintentionally and much more.

Several programs do not offer any direct device selection. Instead they use the *playback device* selected in Windows under

XP: <Control Panel/ Sounds and Multimedia/ Audio>

Vista/7: <Control Panel/ Sound/ Playback>

The program *Sonar* from Cakewalk is unique in many ways. *Sonar* uses the so called **WDM Kernel Streaming**, bypassing the WDM mixer, thus achieves a similar performance as ASIO (see below).

Because of the driver's multichannel streaming ability (option Interleaved, see chapter 12.5), *Sonar* not only finds the stereo device mentioned above, but also the 8-channel interleaved devices, and adds the channel number at the end:

Fireface Analog (1+2) 1/2 is the first stereo device

Fireface Analog (1+2) 3/4 are the channels 3/4 of the first 8-channel interleaved device.

Fireface Analog (3+4) is the next stereo device

It is not recommended to use these special interleaved devices. Also it is not possible to use one stereo channel twice (the basic and the interleaved device).

Multi-Channel using WDM

The WDM Streaming device *Loudspeaker* (Analog 1+2) of the RME driver can operate as usual stereo device, or as up to 8-channel device.

An 8-channel playback using the Windows Media Player requires the speaker setup 7.1 *Surround*. Configure as follows:

XP: >Control Panel /Sounds and Multimedia /Audio /Volume /Speaker Settings /Advanced <

Vista/7: >Control Panel /Sound /Playback /Loudspeaker /Configure <

9.4 Channel Count under WDM

The Fireface's ADAT optical interface offers sample rates of up to 192 kHz using a standard ADAT recorder. For this to work single-channel data is spread to two or four ADAT channels using the *Sample Multiplexing* technique. This reduces the number of available ADAT channels from 8 to 4 or 2 per ADAT port.

Whenever the Fireface changes into Double Speed (88.2/96 kHz) or Quad Speed mode (176.4/192 kHz) all devices no longer available vanish automatically.

WDM Stereo devices	Double Speed	Quad Speed
Fireface UC Analog (1+2)	Fireface UC Analog (1+2)	Fireface UC Analog (1+2)
Fireface UC Analog (3+4)	Fireface UC Analog (3+4)	Fireface UC Analog (3+4)
Fireface UC Analog (5+6)	Fireface UC Analog (5+6)	Fireface UC Analog (5+6)
Fireface UC Analog (7+8)	Fireface UC Analog (7+8)	Fireface UC Analog (7+8)
Fireface UC SPDIF	Fireface UC SPDIF	Fireface UC SPDIF
Fireface UC AS (1+2)	Fireface UC AS (1+2)	Fireface UC AS (1+2)
Fireface UC ADAT (3+4)	Fireface UC ADAT (3+4)	Fireface UC ADAT (3+4)
Fireface UC ADAT (5+6)	Fireface UC ADAT (5+6)	Fireface UC ADAT (5+6)
Fireface UC ADAT (7+8)	Fireface UC ADAT (7+8)	Fireface UC ADAT (7+8)

Note: Under Vista/7 the analog outputs 1/2 show up as *Loudspeaker*.

9.5 Multi-client Operation

RME audio interfaces support multi-client operation. This means several programs can be used at the same time. Also ASIO and WDM can be used simultaneously. The use of multi-client operation requires to follow two simple rules:

- *Multi-client operation requires identical sample rates!*

I.e. it is not possible to use one software with 44.1 kHz and the other with 48 kHz.

- *Different software can not use the same playback channels at the same time.*

If for example Cubase uses channels 1/2, this playback pair can't be used in WaveLab, no matter if ASIO or WDM. However, this is no limitation at all, because TotalMix allows for any output routing, and therefore a playback of multiple software on the same hardware outputs. Note that identical inputs can be used at the same time, as the driver simply sends the data to all applications simultaneously.

ASIO-Multiclient

RME audio interfaces support ASIO multi-client operation. It is possible to use more than one ASIO software at the same time. Again the sample rate has to be identical, and each software has to use its own playback channels. Again the inputs can be used simultaneously.

RME's sophisticated tool *DIGICheck* is an exception to this rule. It operates like an ASIO host, using a special technique to access playback channels already occupied. Therefore DIGICheck is able to analyse and display playback data from any software, no matter which format the software uses.

9.6 Analog Recording

For recordings via the analog inputs the corresponding record device has to be chosen (Fireface UC Analog (x+x)).

The input sensitivity of the rear inputs can be changed via the Settings dialog (Gain/Level) in three steps so that the recording is done with optimized levels. A further improvement is possible by slowly raising the source's output level until the peak level meters in TotalMix reach about -3 dB.

The input sensitivity of the frontside analog inputs can also be adjusted directly at the Fireface via the rotary encoder knob. A Signal LED and a Clip LED help to find the correct level adjustment.

More information is found in chapter 22.2 and 22.3.

It often makes sense to monitor the input signal or send it directly to the output. This can be done at zero latency using **TotalMix** (see chapter 26).

An *automated* control of real-time monitoring can be achieved by Steinberg's ASIO protocol with RME's ASIO drivers and any ASIO 2.0 compatible program. When 'ASIO Direct Monitoring' has been switched on, the input signal is routed in real-time to the output whenever a recording is started (punch-in).

9.7 Digital Recording

Unlike analog soundcards which produce empty wave files (or noise) when no input signal is present, digital interfaces always need a valid input signal to start recording.

Taking this into account, RME added a comprehensive I/O signal status display showing sample frequency, lock and sync status in the Settings dialog, and status LEDs for each input to the Fireface UC.

The sample frequency shown in the Settings dialog (see chapter 11.1, screenshot Settings) is useful as a quick display of the current configuration (the board itself and all connected external equipment). If no sample frequency is recognized, it will read 'No Lock'.

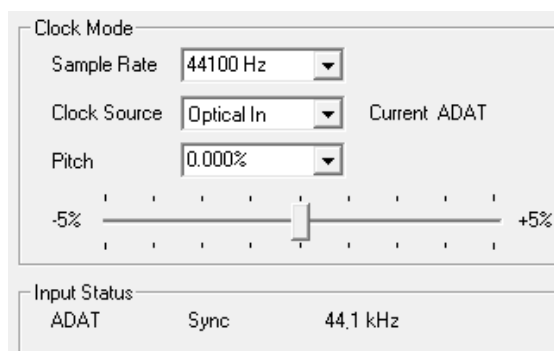

This way, configuring any suitable audio application for digital recording is simple. After selecting the required input, Fireface UC displays the current sample frequency. This parameter can then be changed in the application's audio attributes (or similar) dialog.

9.8 Clock Modes - Synchronization

In the digital world, all devices must be either Master (clock source) or Slave (clock receiver). Whenever several devices are linked, there must always be a single master clock.



A digital system can only have one master! If the Fireface's clock mode is set to 'Internal', all other devices must be set to 'Slave'.

The Fireface UC utilizes a very user-friendly, intelligent clock control, called **AutoSync**. In AutoSync mode, the system constantly scans all digital inputs for a valid signal. If any valid signal is found, the Fireface switches from the internal quartz (*Clock Mode – Current Internal*) to a clock extracted from the input signal (*Clock Mode – Current ADAT* etc). The difference to a usual slave mode is that whenever the clock reference fails, the system will automatically use its internal clock and operate in Master mode.

AutoSync guarantees that record and record-while-play will always work correctly. In certain cases however, e.g. when the inputs and outputs of a DAT machine are connected directly to the Fireface UC, AutoSync may cause feedback in the digital carrier, so synchronization breaks down. Remedy: switch the Fireface clock mode to Master (Clock Source – Internal).

The Fireface UC's ADAT and SPDIF inputs operate simultaneously. Because there is no input selector, the Fireface UC has to be told which one of the signals is the sync reference (a digital device can only be clocked from a *single* source). The Clock Source selection is used to define a preferred input for the automatic clock system. This input will stay active as long as a valid signal is found.

To cope with some situations which may arise in studio practice, defining a sync reference is essential. One example: An ADAT recorder is connected to the ADAT input (ADAT immediately becomes the AutoSync source) and a CD player is connected to the SPDIF input. Try recording a few samples from the CD and you will be disappointed - few CD players can be synchronized. The samples will inevitably be corrupted, because the signal from the CD player is read with the (wrong) clock from the ADAT i.e. out of sync. In this case, the Clock Source should be set temporarily to *SPDIF*.

RME's exclusive **SyncCheck** technology (first implemented in the Hammerfall) enables an easy to use check and display of the current clock status. *Input Status* indicates whether there is a valid signal (Lock, No Lock) for each input (Word Clock, ADAT, SPDIF and LTC), or if there is a valid *and* synchronous signal (Sync). In the field *Clock Mode* the clock reference is shown (Current...). See chapter 35.1.

Under WDM the Fireface will (has to) set the sample rate. Therefore the error shown to the right can occur. A stable signal with a sample rate of 32 kHz is detected at the ADAT input (Sync), but Windows audio had been set to 44100 Hz before. The red color of the text label signals the error condition, and prompts the user to set 32000 Hz manually as sample rate. Under ASIO the audio software sets the sample rate, so that such an error can not happen. If the input sample rate is different then there will be no Sync indication.

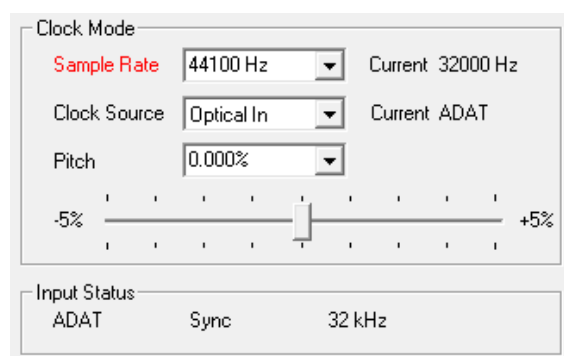

With RME's AutoSync and SyncCheck, finally anyone can master this common source of error, previously one of the most complex issues in the digital studio world.

10. Operation under ASIO

10.1 General

Start the ASIO software and select **ASIO Fireface USB** as the audio I/O device.

Fireface UC supports *ASIO Direct Monitoring* (ADM).

The Fireface UC supports both MME MIDI and DirectMusic MIDI.

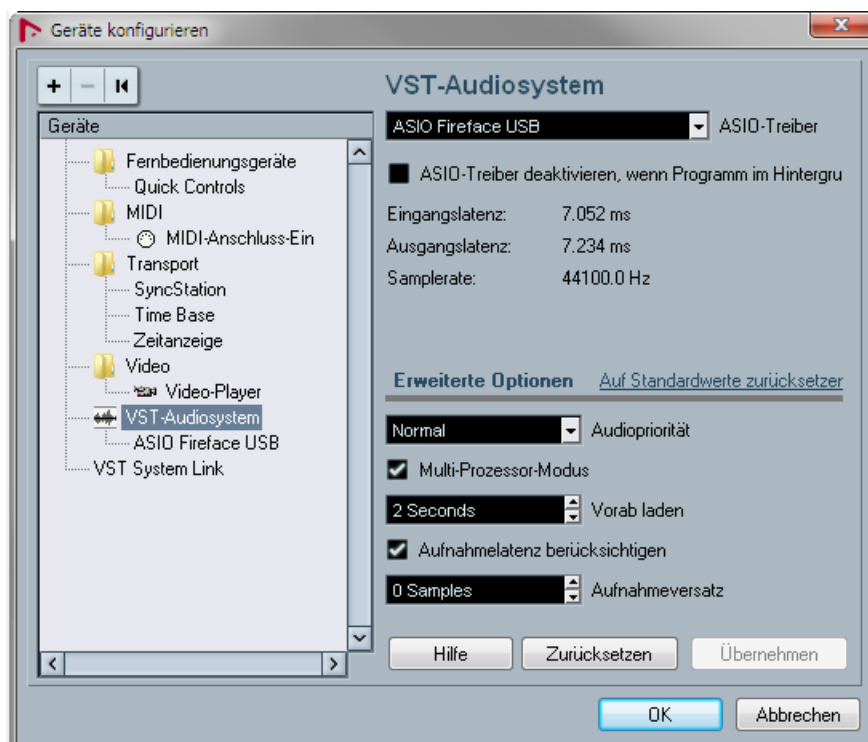

10.2 Channel Count under ASIO

At a sample rate of 88.2 or 96 kHz, the ADAT optical input and outputs operate in S/MUX mode, so the number of available channels is reduced from 8 to 4.

At a sample rate of 176.4 and 192 kHz, the ADAT optical input and outputs operate in S/MUX4 mode, so the number of available channels is limited to 2.

Note: when changing the sample rate range between Single, Double and Quad Speed the number of channels presented from the ASIO driver will change too. This may require a reset of the I/O list in the audio software.

Single Speed	Double Speed	Quad Speed
Fireface UC Analog 1 to 8	Fireface UC Analog 1 to 8	Fireface UC Analog 1 to 8
Fireface UC SPDIF L / R	Fireface UC SPDIF L / R	Fireface UC SPDIF L / R
Fireface UC AS 1 to 2	Fireface UC AS 1 to 2	Fireface UC AS 1 to 2
Fireface UC ADAT 3 to 4	Fireface UC ADAT 3 to 4	Fireface UC ADAT 3 to 4
Fireface UC ADAT 5 to 6	Fireface UC ADAT 5 to 6	Fireface UC ADAT 5 to 6
Fireface UC ADAT 7 to 8	Fireface UC ADAT 7 to 8	Fireface UC ADAT 7 to 8

10.3 Known Problems

If a computer does not provide sufficient CPU-power and/or sufficient USB-bus transfer rates, then drop outs, crackling and noise will appear. Such effects can be avoided by using a higher buffer setting/latency in the Settings dialog of the Fireface UC. Furthermore PlugIns should be deactivated temporarily to make sure they do not cause these problems.

More information can be found in chapter 31.3.

Another common source of trouble is incorrect synchronization. ASIO does not support asynchronous operation, which means that the input and output signals not only have to use the same sample frequency, but also have to be in sync. All devices connected to the Fireface UC must be properly configured for Full Duplex operation. As long as SyncCheck (in the Settings dialog) only displays *Lock* instead of *Sync*, the devices have not been set up properly!

The same applies when using more than one Fireface UC. They all have to be in sync. Else a periodically repeated noise will be heard.

Fireface UC supports *ASIO Direct Monitoring* (ADM). Please note that not every program supports ADM completely or error-free. The most often reported problem is the wrong behaviour of panorama in a stereo channel.

In case of a drift between audio and MIDI, or in case of a fixed deviation (MIDI notes placed close before or behind the correct position), the settings in Cubase/Nuendo have to be changed. At the time of print the option 'Use System Timestamp' should be activated. The Fireface UC supports both MME MIDI and DirectMusic MIDI. It depends on the used application which one will work better.

11. Using more than one Fireface

The current driver supports up to three Fireface UC. All units have to be in sync, i.e. have to receive valid sync information (either via word clock or by using AutoSync and feeding synchronized signals).

- If one of the Firefaces is set to clock mode Master, all others have to be set to clock mode Slave, and have to be synced from the master, for example by feeding word clock. The clock modes of all units have to be set up correctly in the Fireface Settings dialog.
- If all units are fed with a synchronous clock, i.e. all units show *Sync* in their Settings dialog, all channels can be used at once. This is especially easy to handle under ASIO, as the ASIO driver presents all units as one.

The driver takes care of the numbering of all Firefaces, so that it doesn't change. The unit with the lowest serial number is always 'Fireface (1)'. Please note:

- If the Fireface (1) is switched off, Fireface (2) logically turns to the first and only Fireface. If Fireface (1) is switched on later, the numbering changes and the unit becomes Fireface (2) immediately.
- The driver has no control on the numbering of the WDM devices. Therefore it might happen that the WDM devices (2) are mapped to unit (1), especially when switching on more Firefaces during a Windows session. A reboot with all Firefaces already operational should solve this problem.

Note: TotalMix is part of the hardware of each Fireface. Up to three mixers are available, but these are separated and can't interchange data. Therefore a global mixer for all units is not possible.

When using more than one Fireface UC the USB bus might get overloaded. To prevent this connect all units to different USB busses. This should be possible without further hardware as many popular USB 2.0 interfaces come as twins, which can be checked in the Device Manager as follows:

- Connect the Fireface UC to a USB port
- Start the Device Manager, View set to 'Devices by Connection'
- Expand ACPI x86-based PC, Microsoft ACPI compatible System, PCI bus

Here you usually find two entries of a *USB2 Enhanced Host Controller*. All USB devices are connected via a *Root Hub*, the Fireface UC will show up here too. By a simple reconnection to other ports this view lets you check to which one of the two controllers the Fireface is connected to. And with two units, if they use the same controller or not.

This information can also be used to make sure that an external USB hard drive will not interfere with the Fireface UC, by ensuring its connection to a different bus (controller).

Especially with laptops it can be seen that all internal devices and all sockets are connected to the same controller, and that the second controller is not used at all. Then all units operate on the same bus and fight against each other for bandwidth.

12. DIGICheck Windows

The DIGICheck software is a unique utility developed for testing, measuring and analysing digital audio streams. Although this Windows software is fairly self-explanatory, it still includes a comprehensive online help. DIGICheck 5.32 operates as multi-client ASIO host, therefore can be used in parallel to any software, with both inputs and outputs (!). The following is a short summary of the currently available functions:

- **Level Meter.** High precision 24-bit resolution, 2/10/28 channels. Application examples: Peak level measurement, RMS level measurement, over-detection, phase correlation measurement, dynamic range and signal-to-noise ratios, RMS to peak difference (loudness), long term peak measurement, input check. Oversampling mode for levels higher than 0 dBFS. Supports visualization according to the K-System.
- **Hardware Level Meter for Input, Playback and Output.** Reference Level Meter freely configurable, causing near zero CPU load, because calculated from the Fireface hardware.
- **Vector Audio Scope.** World wide unique Goniometer showing the typical afterglow of a oscilloscope-tube. Includes Correlation meter and level meter.
- **Surround Audio Scope.** Professional Surround Level Meter with extended correlation analysis, ITU weighting and ITU summing meter.
- **Spectral Analyser.** World wide unique 10-, 20- or 30-band display in analog bandpass filter technology. 192 kHz-capable!
- **Bit Statistics & Noise.** Shows the true resolution of audio signals as well as errors and DC offset. Includes Signal to Noise measurement in dB and dBA, plus DC measurement.
- **Totalyser.** Spectral Analyser, Level Meter and Vector Audio Scope in a single window.
- **Channel Status Display.** Detailed analysis and display of SPDIF and AES/EBU Channel Status data.
- **Global Record.** Long-term recording of all channels at lowest system load.
- **Completely multi-client.** Open as many measurement windows as you like, on any channels and inputs or outputs!

To install DIGICheck, go to the **\\DIGICheck** directory on the RME Driver CD and run *setup.exe*. Follow the instructions prompted on the screen.

DIGICheck is constantly updated. The latest version is always available on our website www.rme-audio.com, section **Downloads / DIGICheck**.

13. Hotline – Troubleshooting

13.1 General

The newest information can always be found on our website www.rme-audio.com, section FAQ, Latest Additions.

Important: Check that the correct (PC = Windows, AP = Mac) firmware is loaded by a double-click on the rotary encoder.

The input signal cannot be monitored in real-time

- ASIO Direct Monitoring has not been enabled within the DAW, and/or monitoring has been disabled globally (TotalMix Options).

The 8 ADAT channels don't seem to work

- The optical output has been switched to 'SPDIF'. As can be seen in the block diagram, all channels and their assignments still exist, but the optical transmitter has been disconnected from ADAT. The ADAT playback devices are still usable by routing and mixing them in TotalMix to other outputs.

Playback works, but record doesn't

- Check that there is a valid signal at the input. If so, the current sample frequency is displayed in the Settings dialog.
- Check whether the Fireface UC has been selected as recording device in the audio application.
- Check whether the sample frequency set in the audio application ('Recording properties' or similar) matches the input signal.
- Check that cables/devices have not been connected in a closed loop. If so, set the system's clock mode to Master.

Crackle during record or playback

- Increase the number and size of buffers in the 'Settings' dialog or in the application.
- Try different cables (coaxial or optical) to rule out any defects here.
- Check that cables/devices have not been connected in a closed loop. If so, set the system's clock mode to 'Master'.
- Check the Settings dialog for displayed Errors.

Driver installation and Settings dialog/TotalMix work, but a playback or record is not possible

- While recognition and control of the device are low bandwidth applications, playback/record needs the full USB transmission performance. Therefore, defective USB cables with limited transmission bandwidth can cause such errors.

After the flash process the Fireface UC does not start correctly

- Pushing the rotary encoder while switching on the unit will load the Safety BIOS. The flash process should then be repeated, maybe even on a different computer.



User's Guide



Fireface UC

- ▶ **Mac OS X – Installation and Operation**

14. Hardware Installation

- Connect the power supply to the Fireface and then to any suitable power outlet. Power-on the Fireface with the rear power switch.
- Check the correct firmware version by a double click on the rotary encoder button. The display **PC** means Windows, the display **AP** means Mac. The double click automatically switches between both versions. Note: a change of state is only possible when the unit is not connected to the computer.
- Connect computer and Fireface using the supplied USB cable.
- Mac OS X detects the new hardware as **Fireface UC Mac (serial number)**.

15. Driver and Firmware

15.1 Driver Installation

After the Fireface has been connected, (see 14. Hardware Installation) install the drivers from the RME Driver CD. The driver files are located in the folder **Fireface UC**. Installation works automatically by a double-click on the file **Fireface USB.pkg**.

RME recommends downloading the latest driver version from the RME website. If done, the procedure is as follows:

A double-click onto **driver_usb_mac.zip** expands the archive file to **Fireface USB.pkg**. Installation works automatically by a double-click on this file.

During driver installation the programs **Fireface USB Settings** and **Fireface USB Mixer** (TotalMix) are copied to the Applications folder. It is recommended to link these two programs to the Dock so that they are always available.

A reboot of the computer is not required.

Possible reasons why a Fireface UC is not found after driver installation:

- The USB port is not active in the system (check in System Profiler, USB)
- The USB cable is not or not correctly inserted into the socket
- No power. After switching the Fireface on, at least the 7 segment display has to be lit.

15.2 Driver Update

In case of a driver update it's not necessary to remove the old driver first, it will be overwritten during the installation. In case of problems the driver files can be deleted manually by dragging them to the trash bin:

```
/Applications/Fireface USB Mixer
/Applications/Fireface USB Settings
/System/Library/Extensions/FirefaceUSB.kext
/Users/username/Library/Preferences/Fireface USB folder
/Users/username/Library/Preferences/de.rme-audio.FirefaceUSBMixer.plist
/Users/username/Library/Preferences/de.rme-audio.TotalmixFX.plist
/Users/username/Library/Preferences/de.rme-audio.Fireface_USB_Settings.plist
/Library/LaunchAgents/de.rme-audio.firefaceUSBAgent.plist
```

15.3 Firmware Update

The Flash Update Tool updates the firmware of the Fireface UC to the latest version. It requires an already installed driver.

Start the program **Fireface USB Flash**. The Flash Update Tool displays the current revision of the Fireface UC's firmware, and whether it needs an update or not. If so, simply press the 'Update' button. A progress bar will indicate when the flash process is finished (Verify Ok).

If more than one Fireface is installed, all units can be flashed by changing to the next tab and repeating the process.

After the update the unit needs to be reset. This is done by powering down the Fireface for a few seconds. A reboot of the computer is not necessary.

When the update fails (status: failure), the unit's second BIOS will be used from the next cold boot on (Secure BIOS Technology). Therefore the unit stays fully functional. The flash process should then be tried again on a different computer.

The Safety BIOS can also be activated manually: Push the rotary encoder button while switching on the unit. This method is also useful to temporarily deactivate a newer firmware. With pressed button the older version of the firmware will be loaded.

16. Configuring the Fireface

16.1 Settings Dialog

Configuring the Fireface UC is done via its own settings dialog. Start the program **Fireface USB Settings**. The mixer of the Fireface (TotalMix) can be configured by starting the program **Fireface USB Mixer**.

The Fireface's hardware offers a number of helpful, well thought-of practical functions and options which affect how the card operates - it can be configured to suit many different requirements. The following is available in the 'Settings' dialog:

- Level of analog I/Os
- Configuration of digital I/Os
- Synchronization behaviour
- Current sample rate
- State of input and output

Any changes performed in the Settings dialog are applied immediately - confirmation (e.g. by exiting the dialog) is not required.

However, settings should not be changed during playback or record if it can be avoided, as this can cause unwanted noises.

Use the drop down menu **Properties For** to select the unit to be configured.

On the right of it the current firmware and driver version is shown.

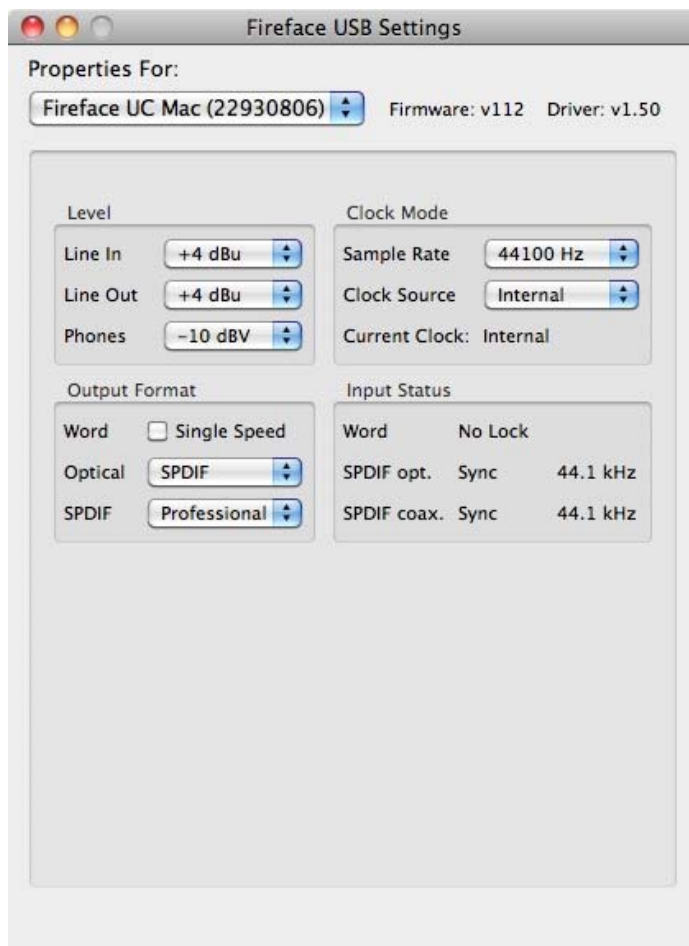

Level**Line In**

Defines the reference level of the rear analog inputs 5-8. The available settings are -10 dBV, +4 dBu and LoGain.

Line Out

Defines the reference level of the rear analog outputs 1-6. The available settings are -10 dBV, +4 dBu and HiGain.

Phones

Defines the reference level of the analog outputs 7/8. The available settings are -10 dBV, +4 dBu and HiGain.

Clock Mode**Sample Rate**

Used to set the current sample rate. This is the same setting as in the Audio MIDI Setup, just added here for your convenience.

At ongoing record/playback the selection is greyed out, so no change is possible.

Clock Source

The unit can be configured to use its own clock (Internal = Master), or one of the input signals (Word, Optical, SPDIF coax., = Slave). If the selected source isn't available, the unit will change to the next available one (AutoSync). If none is available then the internal clock is used. The current clock source is displayed to the right.

Input Status

Indicates for each input (Word, optical, SPDIF coax.) whether there is a valid signal (Lock, No Lock), or if there is a valid *and* synchronous signal (Sync). The second row shows the sample frequency measured by the hardware. In *Clock Mode* the clock reference is shown (Current...). See also chapter 31.1.

Output Format**Word**

The word clock output signal usually equals the current sample rate. Selecting *Single Speed* causes the output signal to always stay within the range of 32 kHz to 48 kHz. So at 96 kHz and 192 kHz sample rate, the output word clock is 48 kHz.

Optical

The optical TOSLINK output can operate as ADAT or SPDIF output. The Channel Status is fixed to Consumer state.

Note: The optical input detects the incoming format automatically.

SPDIF coax.

The coaxial SPDIF output can have the Channel Status Consumer or Professional. For further details please refer to chapter 24.2.

16.2 Clock Modes - Synchronization

In the digital world, all devices must be either Master (clock source) or Slave (clock receiver). Whenever several devices are linked there must always be a single master clock.



A digital system can only have one master! If the Fireface's clock mode is set to 'Internal', all other devices must be set to 'Slave'.

The Fireface UC utilizes a very user-friendly, intelligent clock control, called **AutoSync**. In AutoSync mode, the system constantly scans all digital inputs for a valid signal. If any valid signal is found, the Fireface switches from the internal quartz (*Clock Mode* – Current Internal) to a clock extracted from the input signal (*Clock Mode* – Current ADAT etc). The difference to a usual slave mode is that whenever the clock reference fails, the system will automatically use its internal clock and operate in Master mode.

AutoSync guarantees that record and record-while-play will always work correctly. In certain cases however, e.g. when the inputs and outputs of a DAT machine are connected directly to the Fireface UC, AutoSync may cause feedback in the digital carrier, so synchronization breaks down. Remedy: switch the Fireface clock mode over to Master (Clock Source – Internal).

The Fireface UC's ADAT and SPDIF inputs operate simultaneously. Because there is no input selector, the Fireface UC has to be told which one of the signals is the sync reference (a digital device can only be clocked from a *single* source). The Clock Source selection is used to define a preferred input for the automatic clock system. This input will stay active as long as a valid signal is found.

To cope with some situations which may arise in studio practice, defining a sync reference is essential. One example: An ADAT recorder is connected to the ADAT input (ADAT immediately becomes the AutoSync source) and a CD player is connected to the SPDIF input. Try recording a few samples from the CD and you will be disappointed - few CD players can be synchronized. The samples will inevitably be corrupted, because the signal from the CD player is read with the (wrong) clock from the ADAT i.e. out of sync. In this case, the Clock Source should be set temporarily to *SPDIF*.

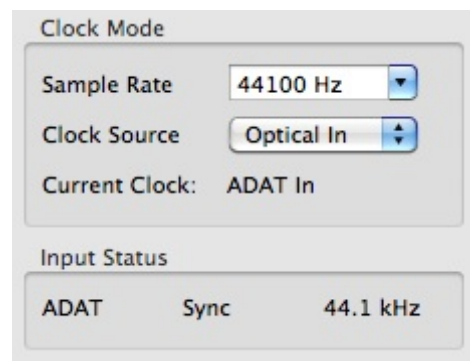

RME's exclusive **SyncCheck** technology (first implemented in the Hammerfall) enables an easy to use check and display of the current clock status. *Input Status* indicates whether there is a valid signal (Lock, No Lock) for each input (Word Clock, ADAT, SPDIF and LTC), or if there is a valid *and* synchronous signal (Sync). In the field *Clock Mode* the clock reference is shown (Current...). See chapter 31.1.

In practice, SyncCheck provides the user with an easy way of checking whether all digital devices connected to the system are properly configured. With SyncCheck, finally anyone can master this common source of error, previously one of the most complex issues in the digital studio world.

17. Mac OS X FAQ

17.1 Round about Driver Installation

The driver with the file suffix **zip** provided by RME is a compressed archive. Zip is directly supported by OS X, a double click on the file is all one needs to do.

The driver consists of a package file (pkg). A double click will start the OS X installer.

The actual audio driver appears as a kernel extension file. The installer copies it to **>System/Library/Extensions<**. Its name is **FirefaceUSB.kext**. It is visible in the Finder, allowing you to verify date and driver version. Yet, in fact this again is a folder containing subdirectories and files.

Nonetheless, this 'driver file' can be removed by simply dragging it to the trash bin. This can be helpful in case a driver installation fails.

17.2 MIDI doesn't work

In some cases the applications do not show the MIDI port. The reason for this is usually visible within the **Audio MIDI Setup**. It displays no RME MIDI device, or the device is greyed out and therefore inactive. Mostly, removing the greyed out device and searching for MIDI devices again will solve the problem.

The Fireface UC is class compliant. Therefore it comes without a driver. OS X recognizes it as MIDI device and will be using it with the driver included in the operating system.

17.3 Repairing Disk Permissions

Repairing permission can solve problems with the installation process - plus many others. To do this, launch **Disk Utility** located in **Utilities**. Select your system drive in the drive/volume list to the left. The **First Aid** tab to the right now allows you to check and repair disk permissions.

17.4 Supported Sample Rates

RME's Mac OS X driver supports all sampling frequencies provided by the hardware. This includes **32 kHz** and **64 kHz**, and even **128 kHz**, **176.4 kHz** and **192 kHz** for the analog and SPDIF I/Os.

But not any software will support all the hardware's sample rates. The hardware's capabilities can easily be verified in the **Audio MIDI Setup**. Select **Audio devices** under **Properties of:** and choose the Fireface UC. A click on **Format** will list the supported sample frequencies.

17.5 Channel Count under Core Audio

The Fireface's ADAT optical interface offers sample rates of up to 192 kHz using a standard ADAT recorder. For this to work single-channel data is spread to two or four ADAT channels using the *Sample Multiplexing* technique. This reduces the number of available ADAT channels from 8 to 4 or 2.

It is not possible to change the number of Core Audio devices without a reboot of the computer. Therefore whenever the Fireface UC changes into Double Speed (88.2/96 kHz) or Quad Speed mode (176.4/192 kHz) all devices stay present, but become partly inactive.

Single Speed	Double Speed	Quad Speed
Fireface UC Analog 1 to 8	Fireface UC Analog 1 to 8	Fireface UC Analog 1 to 8
Fireface UC SPDIF L / R	Fireface UC SPDIF L / R	Fireface UC SPDIF L / R
Fireface UC ADAT 1 to 2	Fireface UC ADAT 1 to 2	Fireface UC ADAT 1 to 2
Fireface UC ADAT 3 to 4	Fireface UC ADAT 3 to 4	Fireface UC ADAT 3 to 4
Fireface UC ADAT 5 to 6	Fireface UC ADAT 5 to 6	Fireface UC ADAT 5 to 6
Fireface UC ADAT 7 to 8	Fireface UC ADAT 7 to 8	Fireface UC ADAT 7 to 8

17.6 Various Information

The driver of the Fireface UC requires at least Mac OS 10.5, as special USB functions are used that are not available in older versions of the operating system.

Via **>System Preferences/ Audio-MIDI Setup<** the hardware can be configured for the system wide usage. Programs that don't support card or channel selection will use the device selected as **Standard-Input** and **Standard-Output**. (Soundstudio, Mplayer, Amplitube etc.).

In the lower part of the window, the audio hardware's capabilities are shown and can be changed in some cases. On the record side no changes are possible. Programs that don't support channel selection will always use channels 1/2, the first stereo pair. To access other inputs, use the following workaround with TotalMix: route the desired input signal to output channels 1/2. In the channel settings of outputs 1/2 activate *Loopback*. Result: the desired input signal is now available at input channel 1/2, without further delay/latency.

Use **Speaker Setup** to freely configure the playback to all available channels. Even multichannel playback (Surround, DVD Player) can be set up this way.

18. Using more than one Fireface

OS X supports the usage of more than one audio device within an audio software. This is done via the Core Audio function **Aggregate Devices**, which allows to combine several devices into one.

The current driver supports up to three Fireface UC. All units have to be in sync, i.e. have to receive valid sync information (either via word clock or by using AutoSync and feeding synchronized signals).

- If one of the Firefaces is set to clock mode Master, all others have to be set to clock mode Slave, and have to be synced from the master, for example by feeding word clock. The clock modes of all units have to be set up correctly in the Fireface Settings dialog.
- If all units are fed with a synchronous clock, i.e. all units show *Sync* in their Settings dialog, all channels can be used at once.

When using more than one Fireface UC the USB bus might get overloaded. To prevent this connect all units to different USB busses.

Note: TotalMix is part of the hardware of each Fireface. Up to three mixers are available, but these are separated and can't interchange data. Therefore a global mixer for all units is not possible.

19. DIGICheck Mac

The DIGICheck software is a unique utility developed for testing, measuring and analysing digital audio streams. Although this Windows software is fairly self-explanatory, it still includes a comprehensive online help. DIGICheck 0.64 operates in parallel to any software, showing all input data. The following is a short summary of the currently available functions:

- **Level Meter.** High precision 24-bit resolution, 2/10/28 channels. Application examples: Peak level measurement, RMS level measurement, over-detection, phase correlation measurement, dynamic range and signal-to-noise ratios, RMS to peak difference (loudness), long term peak measurement, input check. Oversampling mode for levels higher than 0 dBFS. Supports visualization according to the K-System.
- **Hardware Level Meter for Input, Playback and Output.** Reference Level Meter freely configurable, causing near zero CPU load, because calculated from the Fireface hardware.
- **Vector Audio Scope.** World wide unique Goniometer showing the typical afterglow of a oscilloscope-tube. Includes Correlation meter and level meter.
- **Surround Audio Scope.** Professional Surround Level Meter with extended correlation analysis, ITU weighting and ITU summing meter.
- **Spectral Analyser.** World wide unique 10-, 20- or 30-band display in analog bandpass filter technology. 192 kHz-capable!
- **Totalyser.** Spectral Analyser, Level Meter and Vector Audio Scope in a single window.
- **Completely multi-client.** Open as many measurement windows as you like, on any channels and inputs or outputs!

To install DIGICheck, go to the **DIGICheck** directory on the RME Driver CD and run *setup.exe*. Follow the instructions prompted on the screen.

DIGICheck is constantly updated. The latest version is always available on our website www.rme-audio.com, section **Downloads / DIGICheck**.

20. Hotline – Troubleshooting

The newest information can always be found on our website www.rme-audio.com, section FAQ, latest Additions.

Important: Check that the correct (PC = Windows, AP = Mac) firmware is loaded by a double-click on the rotary encoder.

The unit and drivers have been installed correctly, but playback does not work:

- Is Fireface UC listed in the System Profiler? (Vendor ID 2613).
- Has Fireface been selected as current playback device in the audio application?

The 8 ADAT channels don't seem to work

- The optical output has been switched to 'SPDIF'. As can be seen in the block diagram, all channels and their assignments still exist, but the optical transmitter has been disconnected from ADAT. The ADAT playback devices are still usable by routing and mixing them in TotalMix to other outputs.

Playback works, but record doesn't:

- Check that there is a valid signal at the input. If so, the current sample frequency is displayed in the Settings dialog.
- Check whether the Fireface UC has been selected as recording device in the audio application.
- Check whether the sample frequency set in the audio application ('Recording properties' or similar) matches the input signal.
- Check that cables/devices have not been connected in a closed loop. If so, set the system's clock mode to 'Master'.

Crackle during record or playback:

- Increase the number and size of buffers in the application.
- Try different cables (coaxial or optical) to rule out any defects here.
- Check that cables/devices have not been connected in a closed loop. If so, set the system's clock mode to 'Master'.

Possible causes for a Fireface not working

- The USB cable is not, or not correctly inserted into the socket
- No power. After switching the Fireface on, at least the red Host error LED has to be lit.

Driver installation and Settings dialog/TotalMix work, but a playback or record is not possible

- While recognition and control of the device are low bandwidth applications, playback/record needs the full USB transmission performance. Therefore, defective USB cables with limited transmission bandwidth can cause such an error scheme.

After the flash process the Fireface UC does not start correctly

- Pushing the rotary encoder while switching on the unit will load the Safety BIOS. The flash process should then be repeated, maybe even on a different computer.

User's Guide



Fireface UC

▶ Stand-Alone Operation and Connections

24. Stand-alone Operation

The Fireface UC has an internal memory to permanently store all configuration data. The data is stored directly after any change, and are loaded at power-on. Saved settings are:

Settings dialog

Sample rate, clock mode Master/Slave, configuration of the channels and the digital I/Os.

TotalMix

The complete mixer state.

This also improves the clock situation immediately after power-on, avoiding wrong clocking and noise disturbances in a complex setup, caused by wrong synchronization. Usually the unit will be configured by the Windows or Mac driver, so for the time between power-on of the computer up to the loading of the driver its state might be wrong.

This total configuration feature in stand-alone operation - without any connected computer - turns the Fireface into lots of dedicated devices, see examples in chapter 24. Furthermore TotalMix (and with this all application examples) can be MIDI controlled even in stand-alone operation, see chapter 32.7, *Stand-Alone MIDI Control*.

24.1 Front Panel Operation

The knob on the front, a so called rotary encoder, serves to set the input gains and output volumes directly at the unit. The encoder operates either in CHANNEL or in LEVEL mode. Pushing the knob changes between these modes. The currently active mode is indicated by a green LED.

In CHANNEL mode, selection of the desired channel is done by turning the knob. The following strings will be shown in the display:

<i>i.1</i> bis <i>i.4</i>	Mic input 1 up to instrument/line input 4
<i>L.1</i> bis <i>L.6</i>	Line output 1 up to line output 6
<i>PH</i>	Phones (line output 7/8)
<i>SP</i>	SPDIF output
<i>A.1</i> bis <i>A.8</i>	ADAT output 1 up to 8



i.1 / i.2

The gain of the two microphone inputs 1/2 can be defined in the range of 10 dB up to 65 dB in steps of 1 dB. Additionally the setting 0 dB is available. The gain change is performed in analog domain in hardware.

i.3 / i.4

The gain of the two instrument/line inputs 3/4 can be defined in the range of 0 dB up to 18 dB in steps of 0.5 dB. The x.5 dB values are signalled by a dot to the right. The gain change is performed in analog domain in hardware.

L.1 bis L.6, PH, SP, A.1 bis A.8

The output levels of these outputs can be defined in the range +6 dB down to -58 dB in steps of 1 dB. Additionally the setting maximum attenuation (Mute) is available. The gain change is performed digitally by TotalMix.

Stereo Mode

Pushing the knob for more than a second activates the Link (Gang) mode. The display will show *off* or *on*. In stereo (on) mode, the display only presents the left channels of a stereo pair (L1, L3, L5...). The gain and volume setting is then valid for both channels.

24.2 8-Channel AD/DA-Converter

When loading TotalMix' factory default 1 into the unit, the Fireface becomes a high quality 8-channel AD/DA-converter, which also provides a monitoring of all 8 DA-channels via channels 7/8 (Preset 2: also monitoring all 8 inputs). A small modification allows for a monitoring of all I/Os via the SPDIF I/O.

24.3 2-Channel Mic Preamp

Use TotalMix to route the two microphone inputs directly to the analog outputs. This turns the Fireface UC into a 2-channel microphone preamp. The AD- and DA-conversion will cause a small delay of the signals of around 0.35 ms (at 192 kHz, see chapter 35.2). But this is not really relevant, as it is the same delay that would be caused by changing the microphone's position by about 12 centimeter (5 inches).

24.4 Monitor Mixer

TotalMix allows ANY configuration of all I/Os of the Fireface. For example, set up the device as monitor mixer for 8 analog signals, 8 digital via ADAT and 2 via SPDIF. Additionally, TotalMix lets you set up ANY submixes, so all existing outputs can be used for different and independent monitorings of the input signals. The perfect headphone monitor mixer!

24.5 Digital Format Converter

As TotalMix allows for any routing of the input signals, the Fireface UC can be used as ADAT to SPDIF converter, and SPDIF to ADAT converter.

24.6 Analog/digital Routing Matrix

The Matrix in TotalMix enables you to route and link all inputs and outputs completely freely. All the above functionalities are even available simultaneously, can be mixed and combined in many ways. Simply said: the Fireface UC is a perfect analog/digital routing matrix!

25. Analog Inputs

25.1 Line Rear

The Fireface has balanced line inputs as 1/4" TRS jacks on the back of the unit. The electronic input stage is built in a servo balanced design which handles unbalanced (mono jacks) and balanced (stereo jacks) correctly, automatically adjusting the level reference.



When using unbalanced cables with TRS jacks: be sure to connect the 'ring' contact of the TRS jack to ground. Otherwise noise may occur, caused by the unconnected negative input of the balanced input.

One of the main issues when working with an AD-converter is to maintain the full dynamic range within the best operating level. Therefore the Fireface UC internally uses hi-quality electronic switches, which allow for a perfect adaptation of all rear inputs to the three most often used studio levels.

The 'standardized' studio levels do not result in a (often desired) full scale level, but take some additional digital headroom into consideration. The amount of headroom is different in different standards, and again differently implemented by different manufacturers. Because of this we decided to define the levels of the Fireface in the most compatible way.

Reference	0 dBFS @	Headroom
Lo Gain	+19 dBu	15 dB
+4 dBu	+13 dBu	9 dB
-10 dBV	+2 dBV	12 dB

With +4 dBu selected, the according headroom meets the latest EBU recommendations for Broadcast usage. At -10 dBV a headroom of 12 dB is common practice, each mixing desk operating at -10 dBV is able to send and receive much higher levels. Lo Gain is best suited for professional users who prefer to work balanced and at highest levels. Lo Gain provides 15 dB headroom at +4 dBu nominal level.

The above levels are also found in our ADI-8 series of AD/DA converters, the Multiface, and even in our Mic-Preamps QuadMic and OctaMic. Therefore all RME devices are fully compatible to each other.

25.2 Microphone / Line Front

The balanced microphone inputs of the Fireface UC offer an adjustable gain of 10 dB up to 65 dB. The soft switching, hi-current Phantom power (48 Volt) provides a professional handling of condenser mics. The usage of a hi-end integrated circuit (PGA 2500) guarantees outstanding sound quality, stunning low THD, and maximum Signal to Noise ratio in any gain setting.

The two combo jacks also allow for the usage of mono and stereo TRS jacks. The TRS jacks have a fixed level attenuation of 11 dB. Based on the adjustable amplification from +0 dB up to +65 dB, the sensitivity is +21 dBu down to -44 dBu, referenced to full scale of the AD-converter. Therefore the TRS inputs are true full level Line inputs, and the unit can also be used as Line amplifier.

The TRS jacks are free of phantom power.

Two LEDs display a present signal (from -65 dBFS on) and warn against overload (-2 dBFS).

25.3 Instrument / Line Front

The instrument inputs 3/4 of the Fireface UC are exceptionally flexible. Several gain and impedance options make them the ideal receivers for both line and instrument signals.

Line

Inputs 3/4 have balanced line inputs as 1/4" TRS jacks. The electronic input stage is built in a servo balanced design which handles unbalanced (mono jacks) and balanced (stereo jacks) correctly, automatically adjusting the level reference.



When using unbalanced cables with TRS jacks: be sure to connect the 'ring' contact of the TRS jack to ground. Otherwise noise may occur, caused by the unconnected negative input of the balanced input.

Inputs 3/4 operate in perfect harmony with the rear inputs 5 to 8, as they use the same level references:

Reference 5-8	0 dBFS @	Setting 3/4	Input Gain 3/4
Lo Gain	+19 dBu	Pad	+6 dB
+4 dBu	+13 dBu	No Pad	0 dB
-10 dBV	+2 dBV	Inst	0 dB
-	+15 dBu	Inst + Pad	0 dB

Instrument

The main difference between a line- and instrument input is the input's impedance. Via the option **Inst 3** and **Inst 4** in the Settings dialog, the input impedance changes from 10 kOhm to 470 kOhm. At the same time the input sensitivity rises by 10 dB. Using active instruments this setting can already cause overload. Therefore the option **Pad** is still available, reducing the sensitivity by 12 dB.

The instrument input operates servo-balanced, thus handles balanced signals correctly as well.

Input Gain

Via **Input Gain** in the Settings dialog, or using the rotary encoder on the front, an additional gain can be applied to the input signals of channels 3/4. The gain range is 0 dB up to 18 dB, in steps of 0.5 dB. This option not only allows for the use of sources with low level output signals, but for example also to adjust the balance between channel 3 and 4 precisely, already before the recording takes place.

Overall the inputs 3/4 can work with levels from -16 dBu up to +25 dBu. Two LEDs display a present signal (from -65 dBFS on) and warn against overload (-2 dBFS).

26. Analog Outputs

26.1 Line

The eight short circuit protected, low impedance line outputs are available as 1/4" TRS jacks on the back of the unit. The electronic output stage is built in a servo balanced design which handles unbalanced (mono jacks) and balanced (stereo jacks) correctly.

To maintain an optimum level for devices connected to the analog outputs, the Fireface UC internally uses hi-quality electronic switches, which allow for a perfect adaptation of all outputs to the three most often used studio levels.

As with the analog inputs, the analog output levels are defined to maintain a problem-free operation with most other devices. The headroom of the Fireface UC lies between 9 and 15 dB, according to the chosen reference level:

Reference	0 dBFS @	Headroom
Hi Gain	+19 dBu	15 dB
+4 dBu	+13 dBu	9 dB
-10 dBV	+2 dBV	12 dB

With +4 dBu selected, the according headroom meets the latest EBU recommendations for Broadcast usage. At -10 dBV a headroom of 12 dB is common practice, each mixing desk operating at -10 dBV is able to send and receive much higher levels. Lo Gain is best suited for professional users who prefer to work balanced and at highest levels. Lo Gain provides 15 dB headroom at +4 dBu nominal level.

The above levels are also found in our ADI-8 series of AD/DA converters, the Multiface, and even in our Mic-Preamps QuadMic and OctaMic. Therefore all RME devices are fully compatible to each other.

26.2 Phones (7/8)

Channels 7/8 of the Fireface are available on the front via one 1/4" unbalanced TRS jack (stereo output). These channels use the same converters as the other line outputs, therefore offer the same technical specifications.

These outputs are special low impedance types, ready to be used with headphones. But they can also be used as high-quality (yet unbalanced) line outputs. To optimize this stereo output for monitoring purposes, outputs 7/8 have their own 3-stage hardware-based reference level circuitry, providing perfect pre-adjustment for the connected monitor speakers. The main volume control is then performed via TotalMix, either at the computer or directly at the unit (rotary encoder, PH).

In case the output should operate as line output, an adapter TRS plug to RCA phono plugs, or TRS plug to TS plugs is required.

The pin assignment follows international standards. The left channel is connected to the tip, the right channel to the ring of the TRS jack/plug.

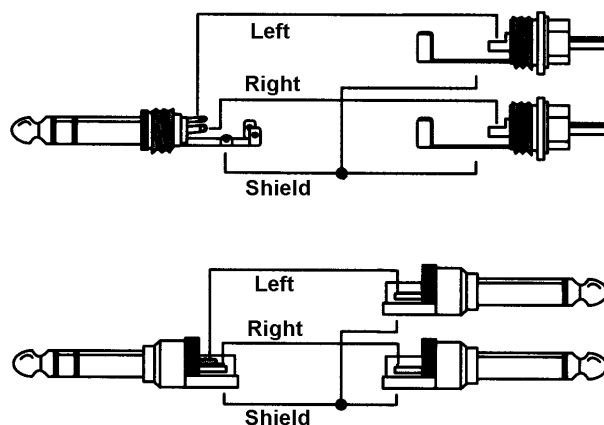

27. Digital Connections

27.1 ADAT

The ADAT optical input of the Fireface UC is fully compatible with all ADAT optical outputs. RME's unsurpassed Bitclock PLL prevents clicks and drop outs even in extreme varipitch operation, and guarantees a fast and low jitter lock to the digital input signal. A usual TOSLINK cable is sufficient for connection. More information on Double Speed (S/MUX) can be found in chapter 35.4.

ADAT In

Interface for a device sending an ADAT signal to the Fireface UC. Carries the channels 1 to 8. When receiving a Double Speed signal, this input carries the channels 1 to 4, at Quad Speed the channels 1 and 2.

ADAT Out

Interface for a device receiving an ADAT signal from the Fireface UC. Transmits channels 1 to 8. When sending a Double Speed signal, this port carries channels 1 to 4, at Quad Speed the channels 1 and 2.

27.2 SPDIF

The Fireface UC has two SPDIF inputs and outputs. Coaxial and optical can be used simultaneously, with different audio signals. Note that the sources have to be synchronous, as the unit does not have a dedicated sample rate converter.

The optical input automatically switches to SPDIF operation when such a signal is detected. The audio information is then shown in TotalMix on the first two ADAT channels, In 11 and In 12.

To send out SPDIF from the optical output, select the option *Optical – SPDIF* in the Settings dialog. The output signal in TotalMix has to be present on the first ADAT channels, AS 1+2.

The Fireface UC's inputs accept SPDIF as well as AES/EBU.

To receive signals in AES/EBU format, an adapter cable is required. Pins 2 and 3 of a female XLR plug are connected individually to the two pins of a phono plug. The cable shielding is connected to pin 1 of the XLR and the ground contact of the phono plug.

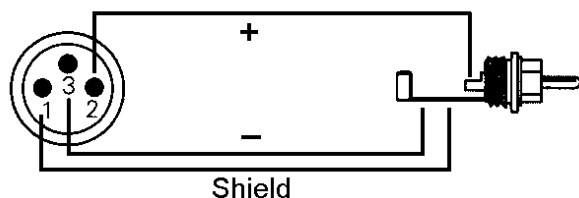

Special Characteristics of the SPDIF Output

Apart from the audio data itself, digital signals in SPDIF or AES/EBU format have a header containing channel status information. False channel status is a common cause of malfunction. The Fireface UC ignores the received header and creates a totally new one for the output signal.

The Fireface UC's new output header is optimized for largest compatibility with other digital devices:

- 32 kHz, 44.1 kHz, 48 kHz, 88.2 kHz, 96 kHz, 176.4 kHz, 192 kHz depending on the current sample rate
- Audio use, Non-Audio
- No Copyright, Copy Permitted
- Format Consumer or Professional
- Category General, Generation not indicated
- 2-channel, No Emphasis
- Aux bits Audio Use

Professional AES/EBU equipment can be connected to the Fireface UC thanks to its 'Professional' format option and a doubled output voltage. Output cables should have the same pinout as those used for input (see above), but with a male XLR plug instead of a female one.



Note that most consumer HiFi equipment (with optical or phono SPDIF inputs) will only accept signals in 'Consumer' format!

Therefore in SPDIF mode the optical output is set fixed to Consumer.

27.3 MIDI

Fireface UC offers two MIDI I/O via four 5-pin DIN jacks. The MIDI ports are added to the system by the driver. Using MIDI capable software, these ports can be accessed under the name *Fireface UC Midi*. Using more than one Fireface, the operating system adds a consecutive number to the port name, like *Fireface UC MIDI (2)* etc.

The MIDI ports support multi-client operation. A MIDI input signal can be received from several programs at the same time. Even the MIDI output can be used by multiple programs simultaneously. However, due to the limited bandwidth of MIDI, this kind of application will often show various problems.

Note: The MIDI input LED displays any kind of MIDI activity, including MIDI Clock, MTC and Active Sensing. The latter is sent by most keyboards every 0.3 seconds.

28. Word Clock

28.1 Word Clock Input and Output

SteadyClock guarantees an excellent performance in all clock modes. Based on the highly efficient jitter suppression, the Fireface refreshes and cleans up any clock signal, and provides it as reference clock at the BNC output (see section 35.8).

Input

The Fireface's word clock input is active when Word has been selected as Clock Source in the Settings dialog and a valid word clock signal is present. The signal at the BNC input can be Single, Double or Quad Speed, the Fireface UC automatically adapts to it. As soon as a valid signal is detected, the WC LED is lit, and the Settings dialog shows either Lock or Sync (see chapter 35.1).

Thanks to RME's *Signal Adaptation Circuit*, the word clock input still works correctly even with heavily mis-shaped, dc-prone, too small or overshoot-prone signals. Thanks to automatic signal centering, 300 mV (0.3V) input level is sufficient in principle. An additional hysteresis reduces sensitivity to 1.0 V, so that over- and undershoots and high frequency disturbances don't cause a wrong trigger.

The Fireface's word clock input is shipped as high impedance type (not terminated). A push switch activates internal termination (75 Ohms). The switch is found on the back beside the word clock input socket. Use a small pencil or similar and carefully push the blue switch so that it snaps into its lock position. The yellow LED will be lit when termination is active. Another push will release it again and de-activate the termination.



Output

The word clock output of the Fireface is constantly active, providing the current sample frequency as word clock signal. As a result, in Master mode the provided word clock is defined by the currently used software. In Slave mode the provided frequency is identical to the one present at the currently chosen clock input. When the current clock signal fails, the Fireface UC switches to Master mode and adjusts itself to the next, best matching frequency (44.1 kHz, 48 kHz etc.).

Selecting *Single Speed* in the Settings dialog causes the output signal to always stay within the range of 32 kHz to 48 kHz. So at 96 kHz and 192 kHz sample rate, the output word clock is 48 kHz.

The received word clock signal can be distributed to other devices by using the word clock output. With this the usual T-adaptor can be avoided, and the Fireface UC operates as *Signal Refresher*. This kind of operation is highly recommended, because

- input and output are phase-locked and in phase (0°) to each other
- *SteadyClock* removes nearly all jitter from the input signal
- the exceptional input (1 Vpp sensitivity instead of the usual 2.5 Vpp, dc cut, *Signal Adaptation Circuit*) plus *SteadyClock* guarantee a secure function even with highly critical word clock signals

Thanks to a low impedance, but short circuit proof output, the Fireface delivers 4 Vpp to 75 Ohms. For wrong termination with 2 x 75 Ohms (37.5 Ohms), there are still 3.3 Vpp at the output.

28.2 Technical Description and Usage

In the analog domain one can connect any device to another device, synchronization is not necessary. Digital audio is different. It uses a clock, the sample frequency. The signal can only be processed and transmitted when all participating devices share the same clock. If not, the signal will suffer from wrong samples, distortion, crackle sounds and drop outs.

AES/EBU, SPDIF and ADAT are self-clocking, an additional word clock connection in principle isn't necessary. But when using more than one device simultaneously problems are likely to happen. For example any self-clocking will not work in a loop cabling, when there is no 'master' (main clock) inside the loop. Additionally the clock of all participating devices has to be synchronous. This is often impossible with devices limited to playback, for example CD players, as these have no SPDIF input, thus can't use the self clocking technique as clock reference.

In a digital studio synchronisation is maintained by connecting all devices to a central sync source. For example the mixing desk works as master and sends a reference signal, the word clock, to all other devices. Of course this will only work as long as all other devices are equipped with a word clock or sync input, thus being able to work as slave (some professional CD players indeed have a word clock input). Then all devices get the same clock and will work in every possible combination with each other.



Remember that a digital system can only have one master!

But word clock is not only the 'great problem solver', it also has some disadvantages. The word clock is based on a fraction of the really needed clock. For example SPDIF: 44.1 kHz word clock (a simple square wave signal) has to be multiplied by 256 inside the device using a special PLL (to about 11.2 MHz). This signal then replaces the one from the quartz crystal. Big disadvantage: because of the high multiplication factor the reconstructed clock will have great deviations called jitter. The jitter of a word clock is typically 15 times higher as when using a quartz based clock.

The end of these problems should have been the so called Superclock, which uses 256 times the word clock frequency. This equals the internal quartz frequency, so no PLL for multiplying is needed and the clock can be used directly. But reality was different, the Superclock proved to be much more critical than word clock. A square wave signal of 11 MHz distributed to several devices - this simply means to fight with high frequency technology. Reflections, cable quality, capacitive loads - at 44.1 kHz these factors may be ignored, at 11 MHz they are the end of the clock network. Additionally it was found that a PLL not only generates jitter, but also rejects disturbances. The slow PLL works like a filter for induced and modulated frequencies above several kHz. As the Superclock is used without any filtering such a kind of jitter and noise suppression is missing.

The actual end of these problems is offered by the **SteadyClock** technology of the Fireface UC. Combining the advantages of modern and fastest digital technology with analog filter techniques, re-gaining a low jitter clock signal of 22 MHz from a slow word clock of 44.1 kHz is no problem anymore. Additionally, jitter on the input signal is highly rejected, so that even in real world usage the re-gained clock signal is of highest quality.

28.3 Cabling and Termination

Word clock signals are usually distributed in the form of a network, split with BNC T-adapters and terminated with resistors. We recommend using off-the-shelf BNC cables to connect all devices, as this type of cable is used for most computer networks. You will find all the necessary components (T-adapters, terminators, cables) in most electronics and/or computer stores. The latter usually carries 50 Ohms components. The 75 Ohms components used for word clock are part of video technology (RG59).

Ideally, the word clock signal is a 5 Volt square wave with the frequency of the sample rate, of which the harmonics go up to far above 500 kHz. To avoid voltage loss and reflections, both the cable itself and the terminating resistor at the end of the chain should have an impedance of 75 Ohm. If the voltage is too low, synchronization will fail. High frequency reflection effects can cause both jitter and sync failure.

Unfortunately there are still many devices on the market, even newer digital mixing consoles, which are supplied with a word clock output that can only be called unsatisfactory. If the output breaks down to 3 Volts when terminating with 75 Ohms, you have to take into account that a device, of which the input only works from 2.8 Volts and above, does not function correctly already after 3 meter cable length. So it is not astonishing that because of the higher voltage, word clock networks are in some cases more stable and reliable if cables are not terminated at all.

Ideally all outputs of word clock delivering devices are designed as low impedance types, but all word clock inputs as high impedance types, in order to not weaken the signal on the chain. But there are also negative examples, when the 75 Ohms are built into the device and cannot be switched off. In this case the network load is often 2 x 75 Ohms, and the user is forced to buy a special word clock distributor. Note that such a device is generally recommended for bigger studios.

The Fireface's word clock input can be high-impedance or terminated internally, ensuring maximum flexibility. If termination is necessary (e.g. because the Fireface is the last device in the chain), push the switch at the back beside the BNC socket (see chapter 28.1).

In case the Fireface UC resides within a chain of devices receiving word clock, plug a T-adapter into its BNC input jack, and the cable supplying the word clock signal to one end of the adapter. Connect the free end to the next device in the chain via a further BNC cable. The last device in the chain should be terminated using another T-adapter and a 75 Ohm resistor (available as short BNC plug). Of course devices with internal termination do not need T-adapter and terminator plug.



Due to the outstanding SteadyClock technology of the Fireface UC, we recommend not to pass the input signal via T-adapter, but to use the Fireface's word clock output instead. Thanks to SteadyClock, the input signal will both be freed from jitter and - in case of loss or drop out – be reset to a valid frequency.

28.4 Operation

The green Lock LED on the front (STATE) will light up as soon as a word clock signal is detected. To change to word clock as clock source, activate clock mode *AutoSync* and switch *Pref. Sync Ref* to *Word Clock* within the Settings dialog. The status display *AutoSync Ref* changes to *Word* as soon as a valid signal is present at the BNC jack. This message has the same meaning as the green *Lock* LED, but appears on the monitor, i.e. the user can check immediately whether a valid word clock signal is present and is currently being used.

The *Input State* also displays the frequency of the current word clock signal, measured by the hardware.



User's Guide



Fireface UC

▶ **TotalMix FX**

26. TotalMix: Routing and Monitoring

26.1 Overview

The Fireface UC includes a powerful digital real-time mixer, the *Fireface mixer*, based on RME's unique, sample-rate independent **TotalMix** technology. It allows for practically unlimited mixing and routing operations, with all inputs and playback channels simultaneously, to any hardware outputs.

Here are some typical applications for TotalMix:

- Setting up delay-free submixes (headphone mixes). The Fireface allows for up to 9 (!) fully independent stereo submixes. On an analog mixing desk, this would equal 18 (!) Aux sends.
- Unlimited routing of inputs and outputs (free utilisation, patchbay functionality).
- Distributing signals to several outputs at a time. TotalMix offers state-of-the-art splitter and distributor functions.
- Simultaneous playback of different programs using only one stereo output. The ASIO multi-client driver allows to use several programs at the same time, but only on different playback channels. TotalMix provides the means to mix and monitor these on a single stereo output.
- Mixing of the input signal to the playback signal (complete ASIO Direct Monitoring). RME not only is *the* pioneer of ADM, but also offers the most complete implementation of the ADM functions.
- Integration of external devices. Use TotalMix to insert external effects devices, be it in the playback or in the record path. Depending on the current application, the functionality equals insert or effects send and effects return, for example as used during real-time monitoring when adding some reverb to the vocals.

Every single input channel, playback channel and hardware output features a Peak and RMS level meter, calculated in hardware. These level displays are very useful to determine the presence and routing destinations of the audio signals.

For a better understanding of the TotalMix mixer you should know the following:

- As shown in the block diagram (next page), the record signal usually stays un-altered. TotalMix does not reside within the record path, and does not change the record level or the audio data to be recorded (exception: loopback mode).
- The hardware input signal can be passed on as often as desired, even with different levels. This is a big difference to conventional mixing desks, where the channel fader always controls the level for all routing destinations simultaneously.
- The level meter of inputs and playback channels are connected pre-fader, to be able to visually monitor where a signal is currently present. The level meters of the hardware's outputs are connected post-fader, thus displaying the actual output level.

RME TotalMix
 Hammerfall DSP Mixer
 Fireface UC
 Block Diagram, 05/2009

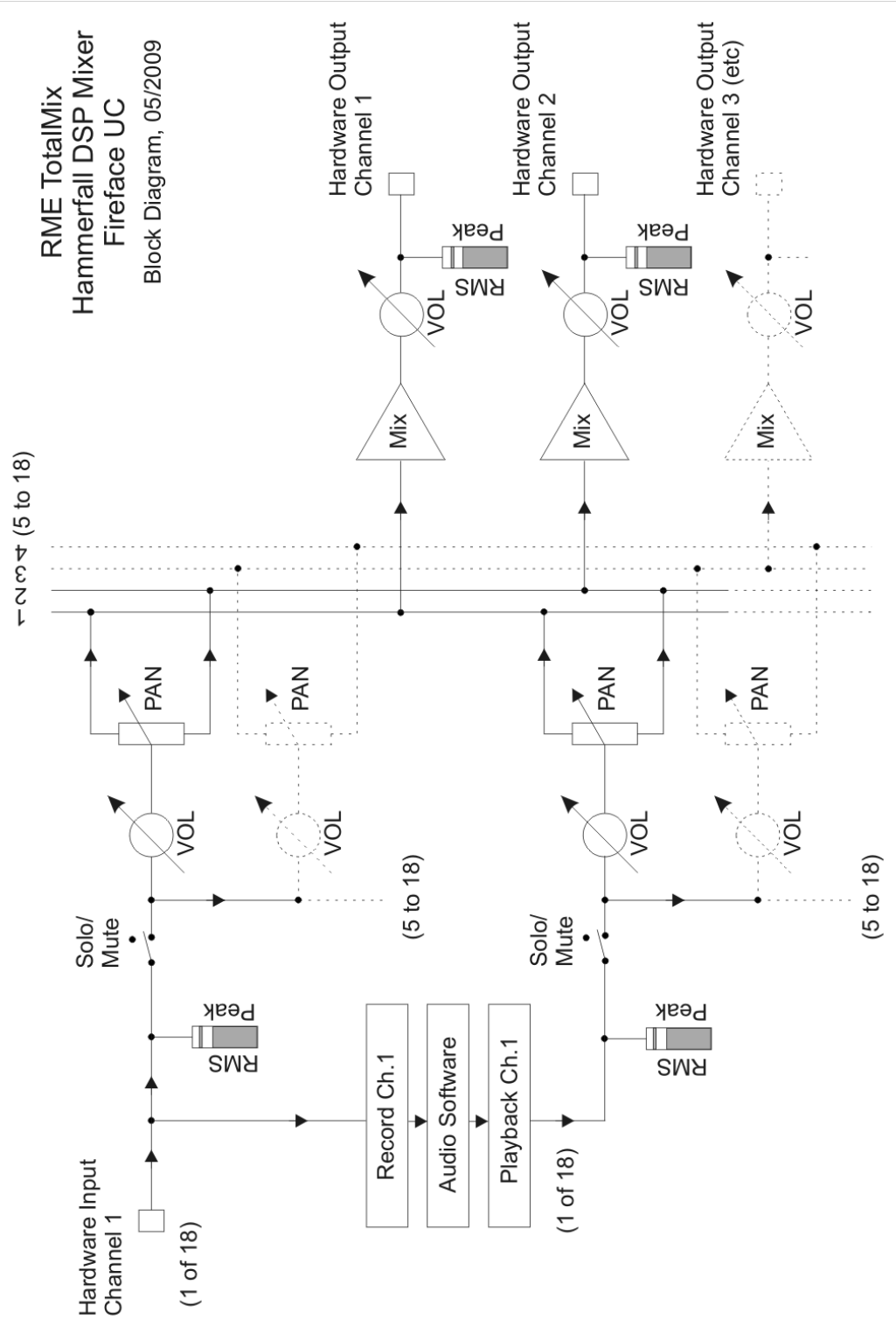

26.2 The User Interface

The visual design of the TotalMix mixer is a result of its capability to route hardware inputs and software playback channels to any hardware output. The Fireface UC provides 18 input channels, 18 software playback channels, and 18 hardware output channels:

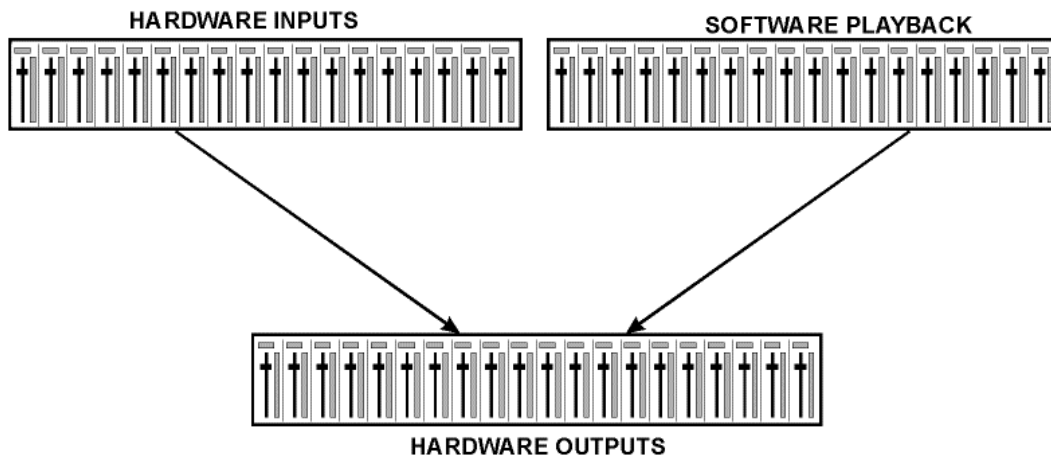

TotalMix can be used in the above view (View Options **2 Rows**). The input channel should be placed above the corresponding output channel. However, the default is a vertical alignment in three rows as known from an Inline desk, so that the row *Software Playback* equals the *Tape Return* of a real mixing desk:

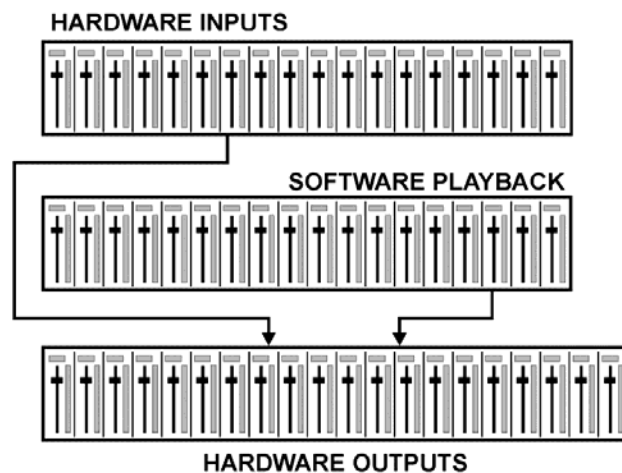

- Top row: Hardware inputs. The level shown is that of the input signal, i. e. fader independent. Via fader and routing field, any input channel can be routed and mixed to any hardware output (bottom row).
- Middle row: Playback channels (playback tracks of the audio software). Via fader and routing field, any playback channel can be routed and mixed to any hardware output (third row).
- Bottom row (third row): Hardware outputs. Here, the total level of the output can be adjusted. This may be the level of connected loudspeakers, or the necessity to reduce the level of an overloaded submix.

The following chapters explain step by step all functions of the user interface.

26.3 The Channels

A single channel can be switched between mono and stereo mode. The mode is set in the channel settings. Hardware Outputs are always stereo.

Channel name. The name field is the preferred place to select a channel by a mouse click. A double click opens a dialog to assign a different name. The original name will be shown when activating the option O-Names in the View Options.

Panorama. Routes the input signal freely to the left and right routing destination (lower label, see below). The level reduction in center position is -3 dB.

Mute and Solo. Input channels and playback channels each have a mute and solo button.

Numerical level display. Shows the current RMS or Peak level, updated twice per second. OVR means overload. The setting Peak/RMS is changed in the View Options.

Level meter. The meter shows both peak values (zero attack, 1 sample is enough for a full scale display) by means of a yellow line, and mathematically correct RMS values by means of a green bar. The RMS display has a relatively slow time constant, so that it shows the average loudness quite well. Overs are shown in red at the top of the bar. In the Preferences dialog (F2) the Peak Hold time, the over detection and the RMS reference can be set.



Fader. Determines the gain/level of the signal routed to the current routing destination (lower label). Please note that this fader is not *the* fader of the channel, but only the fader of the current routing. Compared to a standard mixing desk TotalMix does not have a channel fader, but only Aux Sends, as many as there are hardware outputs. Therefore TotalMix can create as many different Submixes as there are hardware outputs. This concept is understood best in the Submix View, but more on that later.

Below the fader the **Gain** is shown in a numerical display field, according to the current fader position. The fader can be:

- dragged with the left mouse button pressed
- moved by the mouse wheel
- set to 0 dB and $-\infty$ by a double click. The same happens with a single click plus held down Ctrl key.
- adjusted in fine mode by mouse drag and mouse wheel when holding the Shift key down

A Shift-click on a fader adds the fader to the **temporary fader group**. All faders now marked yellow are ganged, and move simultaneously in a relative way. The temporary fader group is deleted by a click on the F symbol in the upper right of the window.



The **arrow symbol** at the bottom minimizes the channel width to that of the level meters. Another click maximizes it again. A mouse click with held Ctrl key causes all channels to the right to enlarge and minimize at once.

The lowest field shows the current **routing target**. A mouse click opens the routing window to select a routing target. The list shows all activated routings of the current channel by arrows in front of the listed entries, the current one is shown in bold letters.

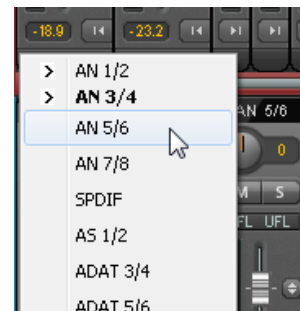

An arrow is only shown with an activated routing. A routing is seen as activated when audio data is sent. As long as the fader is set to $-\infty$ the current routing will be shown in bold letters, but not have an arrow in the front.

Trim Gain. After a click on the double arrow one channel's faders are all synchronized. Instead of changing only a single routing the fader affects all the channel's active routings. For a better overview the faders currently not visible are indicated by orange triangles beside the fader path. When moving the fader the triangles also move to a new position, equalling the faders new settings.

Note that the fader button is set to the highest routing gain of all routings so that best control is offered. The gain (fader knob position) of the currently active routing (the submix selected in the third row) is shown as white triangle.

Background: TotalMix has no fixed channel fader. In case of the Fireface UC there are 9 stereo Aux sends, shown alternately as single fader within the channel strip. The high number of Aux sends enables multiple and fully independent routings.

In some cases it is necessary to synchronize the gain changes of these routings. An example is the Post fader function, where a change of the singer's volume shall be performed identical to the volume change of the signal sent to the reverb device, so that the reverb level keeps its relation to the original signal. Another example is the signal of a guitar that is routed to different submixes, means hardware outputs, which gets much too loud during the solo part, and therefore needs to be reduced in volume on all outputs simultaneously. After a click on the Trim button this can be done easily and with a perfect overview.



As all channel's routings change simultaneously when Trim is active, this mode basically causes the same behaviour as a trim pot within the input channel, affecting the signal already before the mixer. That's how this function got its name.

In the View Options / Routing the function Trim Gains can be globally switched on and off for all channels. The global Trim mode is recommended when using TotalMix FX as live mixing desk.

A click on the tool symbol opens the channel's **Settings** panel with differing elements. For example the Option **Inst** exists only in input channel 2, and the ADAT channels do not offer the phantom power option.

Stereo. Switches the channel to mono or stereo mode.

48V. Activates phantom power at the inputs 1/2. Serves as power supply for high quality condenser mics. This option should stay off with other sources to prevent failure by spikes.

Inst.

Activate the option **Instrument** to use inputs 3 and 4 with instruments. The input impedance is raised to 470 kOhm, the input sensitivity increases by 10 dB.

Pad.

Pad decrease the sensitivity of input channels 3 and 4 by 12 dB.

Gain. Sets the gain for analog inputs 1 to 4. The knob can be adjusted by dragging the mouse or by the mouse wheel. This also works when the mouse has been moved over the two gain displays. Then the gain can be changed separately for left and right channel, even when the channel is in stereo mode.



Width. Setting the stereo width. 1.00 equals full stereo, 0.00 mono, -1.00 swapped channels.

MS Proc. Activates M/S processing within the stereo channel. Monaural information is sent to the left channel, stereo information to the right.

Phase L. Inverts the phase of the left channel by 180°.

Phase R. Inverts the phase of the right channel by 180°.

Note: the functions Width, MS Proc, Phase L and Phase R affect all routings of the respective channel.

Besides Phase L und Phase R the settings of the Hardware Outputs have one more option:

Loopback. Sends the output data to the driver as record data. The corresponding submix can be recorded then. This channel's hardware input sends its data only to TotalMix, no longer to the recording software.

Another difference to the input and playback channels is the **Cue** button instead of Solo. A click on Cue sends the respective Hardware Output's audio to the **Main** Out. With this any hardware output can be controlled and listened to through the monitoring output very conveniently.



26.4 Section Control Room

In the section Control Room the menu Assign is used to define the **Main Out** which is used for listening in the studio. For this output the functions Dim, Recall, Mono and Talkback are automatically applied.

Additionally the channel will be shifted from the Hardware Outputs into the Control Room section, and renamed *Main*. The same happens when assigning Main Out B or the Phones. The original name can be displayed by the function O-Names in the View Options at any time.

Phones 1 to 4 will have dim (set in Settings) and a special routing applied when Talkback is activated. Also putting them beside the Main Out increases the overview within the output section greatly.

Dim. The volume will be reduced by the amount set in the Settings dialog (F3).

Recall. Sets the gain value defined in the Settings dialog. Can also be set at the unit by holding the key Recall down for two seconds.

Mono. Mixes left and right channel. Useful to check for mono compatibility and phase problems.

Talkback. A click on this button will dim all signals on the *Phones* outputs by an amount set up in the Preferences dialog. At the same time the control room's microphone signal (source defined in Preferences) is sent to the *Phones*. The microphone level is adjusted with the channel's input fader.

Speak. B. Switches playback from Main Out to Main Out B. The faders of the channels Main and Speaker B can be ganged via Link.

Assign. Allows to define the Main Out, Main Out B, and up to two Phones outs. The choice is limited to AN 1 to 8, SPDIF and AS 1/2, as at 192 kHz the other ADAT channels are not available anymore.

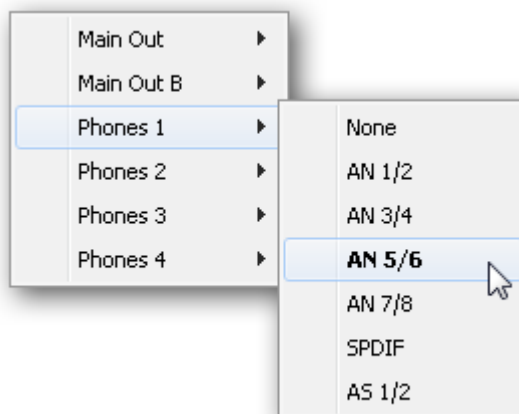

26.5 The Control Strip

The Control Strip on the right side is a fixed element. It combines different functions that are either required globally, or constantly used, and therefore should not be hidden in a menu.

Device selection. Select the unit to be controlled in case more than one is installed on the computer.

Undo / Redo. With the unlimited Undo and Redo changes of the mix can be undone and redone, at any time. Undo/Redo does not cover graphical changes (window size, position, channels wide/narrow etc.), and also no changes to the Presets.

Undo/Redo also operates across Workspaces. Therefore a completely differently set up mixer view can be loaded via Workspace, and with a single click on Undo the previous internal mixer state is returned – but the new mixer view stays.

Global Mute Solo Fader.

Mute. Global Mute operates in a pre fader style, muting all currently activated routings of the channel. As soon as any Mute button is pressed, the *Mute Master* button lights up in the Control Strip area. With this button all selected mutes can be switched off and on again. One can comfortably set up a mute group or activate and deactivate several mute buttons simultaneously.

Solo. As soon as any Solo button is pressed, the *Solo Master* button lights up in the Control Strip area. With this button all selected Solos are switched off and on again. Solo operates as Solo-in-Place, post fader style, as known from common mixing desks. A typical limitation for mixing desks, Solo working only globally and only for the Main Out, does not exist in TotalMix. Solo is always activated for the current submix only.

Fader. A Shift-click on a fader adds the fader to the **temporary fader group**. All faders now marked yellow are ganged, and move simultaneously in a relative way. The temporary fader group is deleted by a click on the F symbol.



View Options. This area combines different functions of routing, the level meters and the mixer view.

Routing

- **Submix:** The Submix view (default) is the preferred view and delivers the quickest overview, operation and understanding of TotalMix. The click on one of the Hardware Output channels selects the respective submix, all other outputs are darkened. At the same time all routing fields are set to this channel. With Submix view, it is very easy to generate a submix for any output: select the output channel, adjust the fader and pans of first and second row – finished.
- **Free:** The Free view is for advanced users. It is used to edit several submixes simultaneously, without the need to change between them. Here one works with the routings fields of the input and playback channels only, which then show different routing destinations.
- **Trim Gains.** Activates all Trim buttons on all channels. TotalMix thus behaves like a conventional, simple mixing desk. Each fader affects all active routings of the channel simultaneously, as if the fader were a trim-pot in the hardware input.

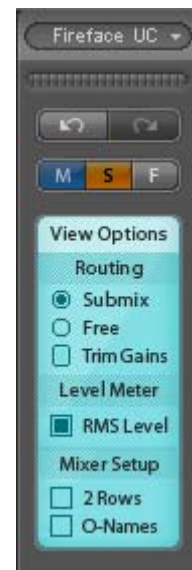

Level Meter

- **RMS Level.** The numerical level display in the channels displays peak or RMS.

Mixer Setup

- **2 Rows.** Switches the mixer view to 2 rows. Hardware Inputs and Software Playbacks are placed side by side. This view saves a lot of space, especially in height.
- **O-Names.** Display of the original names of channels when they had been renamed by the user.

Snapshots. Snapshots include all mixer settings, but no graphical elements like window positions, window size, number of windows, visible settings, scroll states etc. Only the state wide/narrow of the channels is registered. Moreover the Snapshot is only temporarily stored. Loading a Workspace causes the loss of all stored Snapshots, when these all had not been saved before in a Workspace, or separately via *File / Save Snapshot as*. Via *File / Load Snapshot* the mixer states can be loaded individually.

8 different mixes can be stored under individual names in the Snapshot section. A click on any of the 8 buttons loads the corresponding Snapshot. A double click on the name field opens the dialog *Input Name* to edit the name. As soon as the mixer state is changed the button starts flashing. A click on Store lets all buttons flash, whereby the last loaded one, the base of the current state, flashes inversely. The storage finishes by clicking the desired button (means storage place). The storage process is exited by another click on the flashing Store button.

The area Snapshots can be minimized by a click on the arrow in the title bar.

Groups. The area Groups provides 4 storage places each for fader, mute and solo groups. The groups are valid per Workspace, being active and usable in all 8 Snapshots. But with this they are also lost when loading a new workspace, in case they have not been saved before in a different Workspace.

Note: The Undo function will help in case of an accidental overwrite or deletion of the groups.

TotalMix uses flashing signals to guide you through the group setup. After a click on Edit and click on the desired storage place all desired functions for this group have to be activated or selected. The storage process is finished by another click on Edit.

When setting up a fader group, make sure to not add faders that are at the most top or most lowest position, except all faders of that group have this position.

The Mute groups operate – other than the global mute – exclusively for the current routing. This way you can not mute signals on all outputs unintentionally. Instead signals can be muted on specific submixes by the push of a button.

A solo group operates exactly like the global solo, signals outside the current routing are not affected.



26.6 Preferences

The dialog Preferences can be opened via the *Options* menu or directly via F2.

Level Meters

- **Full scale samples for OVR.** Number of consecutive samples to trigger an over detection (1 to 10).
- **Peak Hold Time.** Hold time of the peak value. Adjustable from 0.1 up to 9.9 s.
- **RMS +3 dB.** Shifts the RMS value by +3 dB, so that full scale level is identical for Peak and RMS at 0 dBFS.

Mixer

- **FX Send follows highest Submix.** Not valid for the Fireface UC.
- **Center Balance/Pan when changing Mono/Stereo.** When switching a stereo channel into two mono channels the pan-pots are set fully left and right. This option will set them to center instead.

Snapshots

- **Do not load Main volume/balance.** The values stored in the Snapshot are not loaded for the Main Out, so the current setting is not changed.

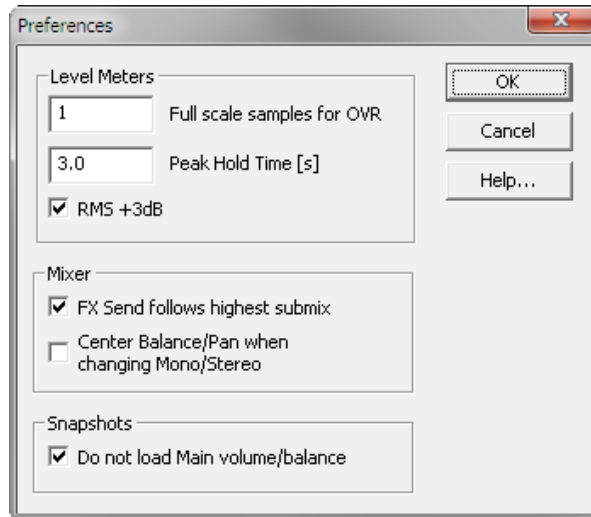

26.7 Settings

The dialog Settings can be opened via the *Options* menu or directly via F3.

Talkback

- **Input.** Selects the input channel of the Talkback signal (microphone in control room). Default: None.
- **Dim.** Amount of attenuation of the signals routed to the *Phones* in dB.

Listenback

- **Input.** Selects the input channel of the Listenback signal (microphone in recording room). Default: None.
- **Dim.** Amount of attenuation of the signals routed to the *Main Out* in dB.

Main Out

- **Recall.** User defined listening volume, activated by the Recall button at the unit or in TotalMix.
- **Dim.** Amount of attenuation for the Main Out in dB, activated by the rotary encoder at the unit or in TotalMix.

MIDI Remote Control

- **MIDI In.** Input where TotalMix receives MIDI Remote data.
- **MIDI Out.** Output where TotalMix sends MIDI Remote data.
- **Disable MIDI in background.** Deactivates MIDI Remote Control as soon as another application is in the focus, or when TotalMix has been minimized.

Mackie Control Options

- **Enable Protocol Support.** When disabled TotalMix will only react on the Control Change commands of chapter 24.5.
- **Map Stereo to 2 Mono Channels.** One fader controls one (mono) channel. Should be disabled when stereo channels are used.
- **Enable full LCD support.** Activates full Mackie Control LCD support with eight channel names and eight volume/pan values.
- **Send Level Messages.** Activates the transmission of the level meter data.

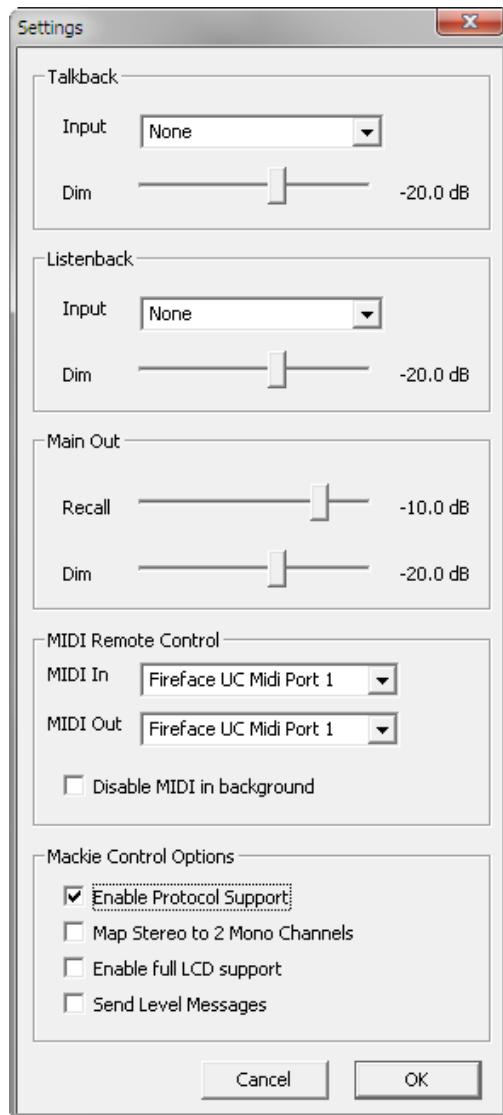

Note: When MIDI Out is set to NONE then TotalMix FX can still be controlled by Mackie Control MIDI commands, but the 8-channel block is not marked as remote target.

26.8 Hotkeys and Usage

TotalMix FX has many hotkeys and mouse/hotkey combinations to speed up and simplify the usage.

The **Shift** key enables a fine-tuning of the gain with all faders and in the Matrix. On all knobs it will speed up the setting.

A click on a **fader** with held down **Shift** key adds the fader to the temporary fader group.

A click in the **fader path** with held down **Shift** key will let the fader jump to 0 dB, at the next click to $-\infty$. Same function: Double click of the mouse.

Clicking on one of the **Panorama** or **Gain** knobs with held down **Shift** key lets the knob jump to center position. Same function: Double click of the mouse.

Clicking on one of the channel settings buttons (slim/normal, settings) with held down **Shift** key lets all channels to the right change their state. For example all settings panels can be opened/closed simultaneously.

A **double click** of the mouse on a knob or its numerical field opens the according *Input Value* dialog. The desired value can then be set by keyboard.

Dragging the mouse from a parameter field increases (move up) or decreases (move down) the value in the field.

Ctrl-N opens the dialog *Function Select* to open a new TotalMix window.

Ctrl-W opens the dialog *File Open* of the operating system to load a TotalMix Workspace file.

The key **W** starts the dialog *Workspace Quick Select* for a direct selection or storage of up to 30 Workspaces.

The key **M** switches the active window to Mixer view. The key **X** switches the active window to Matrix view. **Ctrl-M** opens a new Mixer window, **Ctrl-X** opens a new Matrix window. Another Ctrl-M or Ctrl-X closes the new window again.

F1 opens the online help. The Level Meter setup dialog can be opened with **F2** (same as in DIGICheck). The dialog Preferences is opened with **F3**.

Alt-F4 closes the current window.

Alt and **number** 1 to 8 (not on the numeric keypad!) will load the corresponding Snapshot.

The right mouse button selects a Hardware Output. At the same time a context menu is displayed having these options:

Clear Submix. Deletes the whole submix of the selected output. All inputs and playbacks of this routing will be set to $-\infty$.

Copy Submix. Copies the whole submix of the selected output into memory. All input and playback faders from that routing will be included.

Paste Submix. Writes the previously copied submix on to the now selected output.

26.9 Menu Options

Deactivate Screensaver: When active (checked) any activated Windows screensaver will be disabled temporarily.

Always on Top: When active (checked) the TotalMix window will always be on top of the Windows desktop.

Note: This function may result in problems with windows containing help text, as the TotalMix window will even be on top of those windows, so the help text isn't readable.

Enable MIDI Control: Activates external MIDI control of the TotalMix mixer. In Mackie Protocol mode the channels which are currently under MIDI control are indicated by a colour change of the name field.

Submix linked to MIDI control. The 8-channel group follows the currently selected submix, means Hardware Output, when a different submix is chosen on the remote as well as when doing this in TotalMix. When using multiple windows it can be useful to deactivate this feature for specific windows. The view will not change then.

Preferences: Opens a dialog box to configure several functions of the level meters and the mixer. See chapter 21.7.

Settings. Opens a dialog box to configure several functions like Talkback, Listenback, Main Out and the MIDI Remote Control. See chapter 21.8.

Reset Mix. Offers several options to reset the mixer state:

- **Straight playback with all to Main Out.** All Playback channels are routed 1:1 to the Hardware Outputs. Simultaneously all playbacks are mixed down to the Main Out. The faders in the third row are not changed.
- **Straight Playback.** All Playback channels are routed 1:1 to the Hardware outputs. The faders in the third row are not changed.
- **Clear all submixes.** Deletes all submixes.
- **Clear channel effects.** Not valid for the Fireface UC.
- **Reset output volumes.** All faders of the third row will be set to 0 dB, Main and Speaker B to -10 dB.
- **Reset channel names.** Removes all names assigned by the user.
- **Total Reset.** Playback routing 1:1 with mixdown to Main Out. Switches off all other functions.

27. The Matrix

27.1 Overview

The mixer window of TotalMix looks and operates similar to mixing desks, as it is based on a conventional stereo design. The matrix display presents a different method of assigning and routing channels, based on a single channel or monaural design. The matrix view of the Fireface UC has the look and works like a conventional patchbay, adding functionality way beyond comparable hardware and software solutions. While most patchbays will allow you to connect inputs to outputs with just the original level (1:1, or 0 dB, as known from mechanical patchbays), TotalMix allows you to use a freely definable gain value per crosspoint.

Matrix and TotalMix are different ways of displaying the same processes. Because of this both views are always fully synchronized. Each change in one view is immediately reflected in the other view as well.

27.2 Elements of the Matrix View

The visual design of the TotalMix Matrix is mainly determined by the architecture of the Fireface UC:

- **Horizontal labels.** All hardware outputs
- **Vertical labels.** All hardware inputs. Below are all playback channels.
- **Green 0.0 dB field.** Standard 1:1 routing
- **Black field with number.** Shows the current gain value as dB
- **Blue field.** This routing is muted
- **Brown field.** Phase 180° (inverted)
- **Dark grey field.** No routing.

	Out 1	Out 2	Out 3	Out 4	Out 5
AN 1	-0.0				
AN 2		-5.7			
AN 3			-6.0		
AN 4				-18.3	
AN 5/6					
AN 7/8					

To maintain overview when the window size has been reduced, the labels are floating. They won't leave the visible area when scrolling.

27.3 Operation

Using the Matrix is a breeze. It is very easy to identify the current crosspoint, because the outer labels light up in orange according to the mouse position.

- If input 1 is to be routed to output 1, use the mouse and click one time on crosspoint **In 1 / AN 1** with held down Ctrl key. Two green 0.0 dB field pop in, another click removes them.
- To change the gain (equals the use of a different fader position, see simultaneous display of the mixer view), drag the mouse up or down, starting from the gain field. The value within the field changes accordingly. The corresponding fader in the mixer view is moving simultaneously, in case the currently modified routing is visible.
- On the right side is the Control Strip from the mixer window, adapted to the Matrix. The button for the temporary fader group is missing as well as all View options, as they don't make sense here. Instead the button *Mono Mode* lets you decide whether all the actions performed in the Matrix are valid for two channels or just one.

The Matrix not always replaces the mixer view, but it significantly enhances the routing capabilities and - more important - is a brilliant way to get a fast overview of all active routings. It shows you in a glance what's going on. And since the Matrix operates monaural, it is very easy to set up specific routings with specific gains.

28. Tips and Tricks

28.1 ASIO Direct Monitoring (Windows)

Programs that support ADM (ASIO Direct Monitoring - Samplitude, Sequoia, Cubase, Nuendo etc.) send control commands to TotalMix. This is directly shown by TotalMix. When a fader is moved in the ASIO host the corresponding fader in TotalMix will move too. TotalMix reflects all ADM gain and pan changes in real-time.

But: the faders only move when the currently activated routing (the selected submix) corresponds to the routing in the ASIO host. The Matrix on the other hand will show any change, as it shows all possible routings in one view.

28.2 Copy a Submix

TotalMix allows you to copy complete submixes to other outputs. In case a complex submix is need with only a few changes on a different output, the whole submix can be copied to that output. Right click with the mouse on the original submix output, means Hardware Output. In the context menu select Copy Submix. Then right click on the new submix output, choose Paste Submix in the context menu. Now fine tune the submix.

28.3 Delete a Submix

The easiest and quickest way to delete complex routings is by selection of the according output channel in the mixer view by a right mouse click, and selection of the menu entry *Clear Submix*. As TotalMix FX includes an unlimited undo the delete process can be undone without any problem.

28.4 Doubling the Output Signal

If a mix should be sent out via two different hardware outputs, the most elegant way is to use a permanently activated *Cue*. Set up the mixdown on the routing to the Main Out, use Copy Submix to copy the final mix to the other output, then activate Cue on this other output. The output signal, and with this the complete mixdown, will then be played back from two stereo outputs simultaneously – the Main Out and the other Hardware Output. Even better: the faders of both outputs are still active, so the signal level can be adjusted individually.

28.5 Recording a Submix - Loopback

TotalMix includes an internal loopback function, from the Hardware Outputs to the recording software. Instead of the signal at the hardware input, the signal at the hardware output is sent to the record software. This way, complete submixes can be recorded without an external loopback cable. Also the playback from a software can be recorded by another software.

The function is activated by the **Loopback** button in the Settings panel of the Hardware Outputs. In loopback mode, the signal at the hardware input of the corresponding channel is no longer sent to the recording software, but still passed through to TotalMix. Therefore TotalMix can be used to route this input signal to any hardware output. Using the subgroup recording, the input can still be recorded on a different channel.

As each of the 9 stereo hardware outputs can be routed to the record software, and none of these hardware inputs get lost, TotalMix offers an overall flexibility and performance not rivalled by any other solution.

The risk of feedbacks, a basic problem of loopback methods, is low, because the feedback can not happen within the mixer, only when the audio software is switched into monitoring mode.

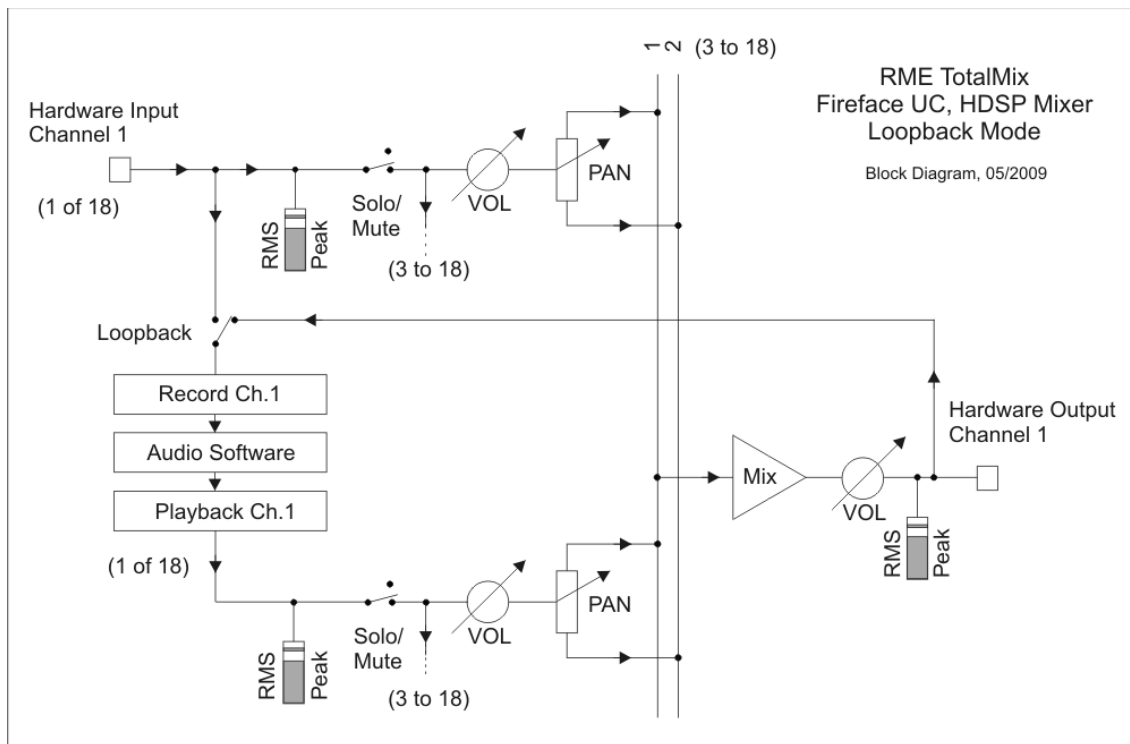

The block diagram shows how the software's input signal is played back, and fed back from the hardware output to the software input.

Recording a Software's playback

In real world application, recording a software's output with another software will show the following problem: The record software tries to open the same playback channel as the playback software (already active), or the playback one has already opened the input channel which should be used by the record software.

This problem can easily be solved. First make sure that all rules for proper multi-client operation are met (not using the same record/playback channels in both programs). Then route the playback signal via TotalMix to a hardware output in the range of the record software, and activate Loopback for recording.

Mixing several input signals into one record channel

In some cases it is useful to record several sources into only one track. For example when using two microphones recording instruments and loudspeakers, TotalMix' Loopback mode saves an external mixing desk. Simply route/mix the input signals to the same output (third row), then redefine this output into a record channel via Loopback. This way any number of input channels from different sources can be recorded into one single track.

28.6 MS Processing

The mid/side principle is a special positioning technique for microphones, which results in a mid signal on one channel and a side signal on the other channel.

These information can be transformed back into a stereo signal quite easily. The process sends the monaural mid channel to left and right, the side channel too, but phase inverted (180°) to the right channel. For a better understanding: the mid channel represents the function L+R, while the side channel represents L-R.



During record the monitoring needs to be done in 'conventional' stereo. Therefore TotalMix also offers the functionality of a M/S-decoder. Activation is done in the Settings panel of the Hardware Input and Software Playback channels via the **MS Proc** button.

The M/S-Processing automatically operates as M/S encoder or decoder, depending on the source signal format. When processing a usual stereo signal, all monaural information will be shifted into the left channel, all stereo information into the right channel. Thus the stereo signal is M/S encoded. This yields some interesting insights into the mono/stereo contents of modern music productions. Additionally some very interesting methods of manipulating the stereo base and generating stereo effects come up, as it is then very easy to process the side channel with Low Cut, Expander, Compressor or Delay.

The most basic application is the manipulation of the stereo width: a change of the level of the side channel allows to manipulate the stereo width from mono to stereo up to extended.

29. MIDI Remote Control

29.1 Overview

TotalMix can be remote controlled via MIDI. It is compatible to the widely spread Mackie Control protocol, so TotalMix can be controlled with all hardware controllers supporting this standard. Examples are the Mackie Control, Tascam US-2400 or Behringer BCF 2000.

Additionally, the stereo output faders (lowest row) which are set up as *Main Out* in the Control Room section can also be controlled by the standard **Control Change Volume** via **MIDI channel 1**. With this, the main volume of the Fireface UC is controllable from nearly any MIDI equipped hardware device.

MIDI Remote Control always operates in View *Submix* mode, even when the View Option *Free* is currently selected in TotalMix FX.

29.2 Mapping

TotalMix supports the following Mackie Control surface elements*:

Element:	Meaning in TotalMix:
Channel faders 1 – 8	volume
Master fader	Main Monitor channel's faders
SEL(1-8) + DYNAMICS	Activate Trim mode
V-Pots 1 – 8	pan
pressing V-Pot knobs	pan = center
CHANNEL LEFT or REWIND	move one channel left
CHANNEL RIGHT or FAST FORWARD	move one channel right
BANK LEFT or ARROW LEFT	move eight channels left
BANK RIGHT or ARROW RIGHT	move eight channels right
ARROW UP or Assignable1/PAGE+	move one row up
ARROW DOWN or Assignable2/PAGE-	move one row down
EQ	Master Mute
PLUGINS/INSERT	Master Solo
STOP	Dim Main Out
PLAY	Talkback
PAN	Mono Main Out
FLIP	Speaker B
DYN	TrimGains
MUTE Ch. 1 – 8	Mute
SOLO Ch. 1 – 8	Solo
SELECT Ch. 1 – 8	Select
REC Ch. 1 – 8	select output bus (Submix)
RECORD	Recall
F1 - F8	load Snapshot 1 - 8
F9	select Main Out
F10 - F11	select Cue Phones 1 - 2

*Tested with Behringer BCF2000 Firmware v1.07 in Mackie Control emulation for Steinberg mode and with Mackie Control under Mac OS X.

29.3 Setup

Open the Preferences dialog (menu Options or F3). Select the MIDI Input and MIDI Output port where your controller is connected to.

When no feedback is needed select NONE as MIDI Output.

Check *Enable MIDI Control* in the Options menu.

29.4 Operation

The channels being under Mackie MIDI control are indicated by a colour change of the name field, black turns to brown.

The 8-fader block can be moved horizontally and vertically, in steps of one or eight channels.

In Submix View mode, the current routing destination (output bus) can be selected via REC Ch. 1 – 8. This equals the selection of a different output channel in the lowest row by a mouse click when in Submix View. In MIDI operation it is not necessary to jump to the lowest row to perform this selection. This way even the routing can be easily changed via MIDI.

Full LC Display Support. This option in Preferences (F3) activates complete Mackie Control LCD support with eight channel names and eight volume/pan values. When *Full LC Display Support* is turned off, a brief information about the first fader of the block (channel and row) is sent. This brief information is also available on the LED display of the Behringer BCF2000.

Tip for Mac OS X users: LC Xview (www.opuslocus.com) provides an on-screen display emulating the hardware displays of a Logic/Mackie Control, for use with controllers that can emulate a Logic/Mackie Control but do not have a display. Examples include the Behringer BCF2000 and Edirol PCR-series.

Disable MIDI in Background (menu Options, Settings) disables the MIDI control as soon as another application is in the focus, or in case TotalMix has been minimized. This way the hardware controller will control the main DAW application only, except when TotalMix is in the foreground. Often the DAW application can be set to become inactive in background too, so that MIDI control is switched between TotalMix and the application automatically when switching between both applications.

TotalMix also supports the 9th fader of the Mackie Control. This fader (labelled Master) will control the stereo output fader (lowest row) which is set up as *Main Out* in the Control Room section.

29.5 MIDI Control

The hardware output set up as *Main Out* can be controlled by the standard **Control Change Volume** via **MIDI channel 1**. With this, the main volume of the Fireface UC is controllable from nearly any MIDI equipped hardware device.

Even if you don't want to control all faders and pans, some buttons are highly desirable to be available in 'hardware'. These are mainly the *Talkback* and the *Dim* button, and the monitoring options (listen to Phones submixes). Fortunately a Mackie Control compatible controller is not required to control these buttons, as they are steered by simple Note On/Off commands on MIDI channel 1.

The notes are (hex / decimal / keys):

Dim: 5D / 93 / **A 6**

Mono: 2A / 42 / **#F 2**

Talkback: 5E / 94 / **#A 6**

Recall: 5F / 95 / **H 6**

Speaker B: 32 / 50 / **D3**

Cue Main Out: 3E / 62 / **D 4**

Cue Phones 1: 3F / 63 / **#D 4**

Cue Phones 2: 40 / 64 / **E 4**

Cue Phones 3: 41 / 65 / **F 4**

Cue Phones 4: 42 / 66 / **#F 4**

Snapshot 1: 36 / 54 / **#F 3**

Snapshot 2: 37 / 55 / **G 3**

Snapshot 3: 38 / 56 / **#G 3**

Snapshot 4: 39 / 57 / **A 3**

Snapshot 5: 3A / 58 / **#A 3**

Snapshot 6: 3B / 59 / **B 3**

Snapshot 7: 3C / 60 / **C 4**

Snapshot 8: 3D / 61 / **#C 4**

Trim Gains: 2D / 45 / **A 2**

Master Mute: 2C / 44 / **#G2**

Master Solo: 2B / 43 / **G2**

Furthermore all faders of all three rows can be controlled via simple **Control Change** commands. The format for the Control Change commands is:

Bx yy zz

x = MIDI channel

yy = control number

zz = value

The first row in TotalMix is addressed by MIDI channels 1 up to 4, the middle row by channels 5 up to 8 and the bottom row by channels 9 up to 12.

16 Controller numbers are used: 102 up to 117 (= hex 66 to 75). With these 16 Controllers (= faders) and 4 MIDI channels each per row, up to 64 faders can be controlled per row (as required by the HDSPE MADI).

Examples for sending MIDI strings:

- Set input 1 to 0 dB: B0 66 68
- Set input 5 to maximum attenuation: B1 6A 0
- Set playback 1 to maximum: B4 66 7F
- Set Output 3 to 0 dB: B8 68 68

Note: Sending MIDI strings requires to use programmer's logic for the MIDI channel, starting with 0 for channel 1 and ending with 15 for channel 16.

Further functions:

- Trim Gains On: BC 66 xx (BC = MIDI channel 13, xx = any value)
- Trim Gains Off: BC 66 xx or select a submix

Select submix (fader) in third row:

- channel 1/2: BC 68/69 xx
 - channel 3/4: BC 6A/6B xx
- etc.

29.6 Loopback Detection

The Mackie Control protocol requires feedback of the received commands, back to the hardware controller. So usually TotalMix will be set up with both a MIDI input and MIDI output. Unfortunately any small error in wiring and setup will cause a MIDI feedback loop here, which then completely blocks the computer (the CPU).

To prevent the computer from freezing, TotalMix sends a special MIDI note every 0.5 seconds to its MIDI output. As soon as it detects this special note at the input, the MIDI functionality is disabled. After fixing the loopback, check *Enable MIDI Control* under Options to reactivate the TotalMix MIDI.

29.7 Stand-Alone MIDI Control

When not connected to a computer, the Fireface UC can be controlled **directly** via MIDI. To unlock the special **stand-alone MIDI control mode** first activate MIDI control in TotalMix (menu Options, *Enable MIDI Control*). Turning this mode off is done with MIDI control deactivated.

Note: When not needed the stand-alone MIDI operation should not be active, as the unit will react on MIDI notes after power-on, and will also send MIDI notes.

Control is performed via the **Mackie Control protocol**. In stand-alone mode not all functions known from TotalMix are available. Functions like *Talkback, DIM, Mono, Solo, relative* ganging of the faders, *Monitor Main* and *Monitor Phones* are realized by complex software code, and not present within the hardware.

Still many functions, and especially the most important functions to control the Fireface UC, are implemented in hardware, thus available also in stand-alone mode:

- All faders and pans of the first and third row
- Mute of the input signal per channel
- Ganging via 'Select'
- Choice of the routing destination, i.e. the current submix
- Sending of LED and display data to the MIDI controller

The second row (software playback) is skipped in stand-alone operation. The Fireface UC sends display data as brief information, enabling an easy navigation through lines and rows. Other data like PAN and miscellaneous status LEDs are supported as well.

In stand-alone mode the unit always operates in **View Submix** mode. Only this way the routing destination can be changed, and several mixdowns/submixes can be set up quickly and easily.

Note: After power-on the Fireface UC does not update the connected MIDI controller. Therefore the controller's faders will not be set to the values stored within the unit.

Mackie Control Protocol

The stand-alone operation supports the following Mackie Control surface elements*:

*Tested with Behringer BCF2000 Firmware v1.07 in Mackie Control emulation for Steinberg mode.

Element:	Meaning in Fireface:
Channel faders 1 – 8	volume
SEL(1-8) + DYNAMICS	reset fader to Unity Gain
V-Pots 1 – 8	pan
pressing V-Pot knobs	pan = center
CHANNEL LEFT or REWIND	move one channel left
CHANNEL RIGHT or FAST FORWARD	move one channel right
BANK LEFT or ARROW LEFT	move eight channels left
BANK RIGHT or ARROW RIGHT	move eight channels right
ARROW UP or Assignable1/PAGE+	move one row up
ARROW DOWN or Assignable2/PAGE-	move one row down
EQ	Master Mute
MUTE Ch. 1 – 8	Mute
SELECT Ch. 1 – 8	Select
REC Ch. 1 – 8	select output bus (current submix)

User's Guide



Fireface UC

▶ **Technical Reference**

30. Technical Specifications

30.1 Analog

AD, Line In 5-8, rear

- Resolution AD: 24 bit
- Signal to Noise ratio (SNR): 110 dB RMS unweighted, 113 dBA
- Frequency response @ 44.1 kHz, -0.1 dB: 5 Hz – 20.6 kHz
- Frequency response @ 96 kHz, -0.5 dB: 5 Hz – 45.3 kHz
- Frequency response @ 192 kHz, -1 dB: 5 Hz - 90 kHz
- THD: < -100 dB, < 0.001 %
- THD+N: < -98 dB, < 0.0012 %
- Channel separation: > 110 dB
- Maximum input level: +19 dBu
- Input: 6.3 mm TRS jack, electronically balanced
- Input impedance: 10 kOhm
- Input sensitivity switchable to Lo Gain, +4 dBu, -10 dBV
- Input level for 0 dBFS @ Lo Gain: +19 dBu
- Input level for 0 dBFS @ +4 dBu: +13 dBu
- Input level for 0 dBFS @ -10 dBV: +2 dBV

Line In 3-4, front

- as AD, but:
- Signal to Noise ratio (SNR): 105 dB RMS unweighted, 109 dBA
- Gain range via rotary encoder: 0 up to +18 dB
- Maximum input level, Gain 0 dB: +19 dBu
- Maximum input level, Gain 18 dB, Inst: -16 dBu
- CLIP LED: -2 dBFS
- SIG LED: -65 dBFS

Microphone/Line 1-2, front

- as AD Line In 5-8, but:
- Input: Neutrik XLR/TRS Combo jack, electronically balanced
- Input impedance: XLR 2 kOhm, TRS 8 kOhm balanced
- Low Roll Off -0.5 dB: 18 Hz, -1 dB: 12 Hz
- Gain range: 0 dB, +10 up to +65 dB
- Maximum input level XLR, Gain 0 dB: +10 dBu
- Maximum input level XLR, Gain 65 dB: -55 dBu
- Maximum input level TRS, Gain +0 dB: +21 dBu
- Maximum input level TRS, Gain +65 dB: -44 dBu
- CLIP LED: -2 dBFS
- SIG LED: -65 dBFS

DA, Line Out 1-6, rear

- Resolution: 24 bit
- Dynamic range (DR): 110 dB, 113 dBA @ 44.1 kHz (unmuted)
- Frequency response @ 44.1 kHz, -0.1 dB: 1 Hz – 20.4 kHz
- Frequency response @ 96 kHz, -0.5 dB: 1 Hz – 44.8 kHz
- Frequency response @ 192 kHz, -1 dB: 1 Hz - 80 kHz
- THD: -100 dB, < 0.001 %
- THD+N: -96 dB, < 0.0015 %
- Channel separation: > 110 dB
- Maximum output level: +19 dBu
- Output: 6.3 mm TRS jack, servo-balanced
- Output impedance: 75 Ohm
- Output level switchable Hi Gain, +4 dBu, -10 dBV
- Output level at 0 dBFS @ Hi Gain: +19 dBu
- Output level at 0 dBFS @ +4 dBu: +13 dBu
- Output level at 0 dBFS @ -10 dBV: +2 dBV

DA – Phones, 7/8, front

- as DA, but:
- Output: 6.3 mm TRS jack, unbalanced
- Output impedance: 30 Ohm

30.2 MIDI

- 2 x MIDI I/O breakout cable with 4 x 5-pin DIN jacks
- Galvanically isolated by optocoupled input
- Hi-speed mode: Jitter and response time typically below 1 ms
- Separate 128 byte FIFOs for input and output

30.3 Digital

- Clocks: Internal, ADAT In, SPDIF In, word clock in. Optional LTC/Video in
- Low Jitter Design: < 1 ns in PLL mode, all inputs
- Internal clock: 800 ps Jitter, Random Spread Spectrum
- Jitter suppression of external clocks: > 30 dB (2.4 kHz)
- Effective clock jitter influence on AD and DA conversion: near zero
- PLL ensures zero dropout, even at more than 100 ns jitter
- Digital Bitclock PLL for trouble-free varispeed ADAT operation
- Supported sample rates: 28 kHz up to 200 kHz

30.4 Digital Inputs

Word Clock

- BNC, not terminated (10 kOhm)
- Switch for internal termination 75 Ohm
- Automatic Double/Quad Speed detection and internal conversion to Single Speed
- SteadyClock guarantees super low jitter synchronization even in varispeed operation
- Not affected by DC-offsets within the network
- Signal Adaptation Circuit: signal refresh through auto-center and hysteresis
- Overvoltage protection
- Level range: 1.0 Vpp – 5.6 Vpp
- Lock Range: 27 kHz – 200 kHz
- Jitter when synced to input signal: < 1 ns
- Jitter suppression: > 30 dB (2.4 kHz)

ADAT Optical

- 1 x TOSLINK
- Standard: 8 channels 24 bit, up to 48 kHz
- Double Speed (S/MUX): 4 channels 24 bit 96 kHz
- Quad Speed (S/MUX4) : 2 channels 24 bit 192 kHz
- Bitclock PLL ensures perfect synchronisation even in varispeed operation
- Lock Range: 31.5 kHz – 50 kHz
- Jitter when synced to input signal: < 1 ns
- Jitter suppression: > 30 dB (2.4 kHz)

AES/EBU - SPDIF

- 1 x RCA and 1 x optical, according to IEC 60958
- High-sensitivity input stage (< 0.3 Vpp)
- Accepts Consumer and Professional format, copy protection will be ignored
- Lock Range: 27 kHz – 200 kHz
- Jitter when synced to input signal: < 1 ns
- Jitter suppression: > 30 dB (2.4 kHz)

30.5 Digital Outputs

Word Clock

- BNC
- Max. output voltage: 5 Vpp
- Output voltage @ 75 Ohm termination: 4.0 Vpp
- Output impedance: 10 Ohm
- Frequency range: 27 kHz – 200 kHz

ADAT

- 1 x TOSLINK
- Standard: 8 channels 24 bit, up to 48 kHz
- Double Speed (S/MUX): 4 channels 24 bit 96 kHz
- Quad Speed (S/MUX4) : 2 channels 24 bit 192 kHz

AES/EBU - SPDIF

- 1 x RCA and 1 x optical, according to IEC 60958
- Output level Professional 2.0 Vpp, Consumer 0.8 Vpp
- Format Professional according to AES3-1992 Amendment 4
- Format Consumer (SPDIF) according to IEC 60958
- Single Wire mode, sample rate 28 kHz up to 200 kHz

30.6 General

- Power supply: external power supply
- Typical power consumption: 13 Watts
- Current at 12 Volt operating voltage: 910 mA (11 Watts)
- Dimensions including rack ears (WxHxD): 265 x 44 x 165 mm (10.5" x 1.73" x 6.5")
- Dimensions without rack ears/handles (WxHxD): 218 x 44 x 155 mm (8.6" x 1.73" x 6.1")
- Weight: 1.5 kg (3.3 lbs)
- Temperature range: +5° up to +50° Celsius (41° F up to 122°F)
- Relative humidity: < 75%, non condensing
- Included power supply: Internal switching PSU, 100 - 240 V AC, 2 A, 24 Watts

31. Technical Background

31.1 Lock and SyncCheck

Digital signals consist of a carrier and the data. If a digital signal is applied to an input, the receiver has to synchronize to the carrier clock in order to read the data correctly. To achieve this, the receiver uses a PLL (Phase Locked Loop). As soon as the receiver meets the exact frequency of the incoming signal, it is locked. This **Lock** state remains even with small changes of the frequency, because the PLL tracks the receiver's frequency.

If an ADAT or SPDIF signal is applied to the Fireface UC, the corresponding input LED starts flashing. The unit indicates LOCK, i. e. a valid input signal (in case the signal is also in sync, the LED is constantly lit, see below).

Unfortunately, LOCK does not necessarily mean that the received signal is correct with respect to the clock which processes the read out of the embedded data. Example [1]: The Fireface is set to 44.1 kHz internally (clock mode Master), and a mixing desk with ADAT output is connected to input ADAT. The corresponding LED will show LOCK immediately, but usually the mixing desk's sample rate is generated internally (also Master), and thus slightly higher or lower than the Fireface's internal sample rate. Result: When reading out the data, there will frequently be read errors that cause clicks and drop outs.

Also when using multiple inputs, a simple LOCK is not sufficient. The above described problem can be solved elegantly by setting the Fireface from Master to AutoSync (its internal clock will then be the clock delivered by the mixing desk). But in case another, un-synchronous device is connected, there will again be a slight difference in the sample rate, and therefore clicks and drop outs.

In order to display those problems optically at the device, the Fireface includes **SyncCheck**. It checks all clocks used for *synchronicity*. If they are not synchronous to each other (i. e. absolutely identical), the SYNC LED of the asynchronous input flashes. In case they are completely synchronous, all LEDs are constantly lit. In example 1 it would have been obvious that the LED ADAT kept on flashing after connecting the mixing desk.

In practice, SyncCheck allows for a quick overview of the correct configuration of all digital devices. So one of the most difficult and error-prone topics of the digital studio world finally becomes easy to handle.

The same information is presented in the Fireface's Settings dialog. In the status display *Input State* the state of all clocks is decoded and shown as simple text (No Lock, Lock, Sync).

31.2 Latency and Monitoring

The term **Zero Latency Monitoring** has been introduced by RME in 1998 for the DIGI96 series of audio cards. It stands for the ability to pass-through the computer's input signal at the interface directly to the output. Since then, the idea behind has become one of the most important features of modern hard disk recording. In the year 2000, RME published two ground-breaking Tech Infos on the topics *Low Latency Background*, which are still up-to-date: *Monitoring, ZLM and ASIO*, and *Buffer and Latency Jitter*, both found on the RME website.

How much Zero is Zero?

From a technical view there is no zero. Even the analog pass-through is subject to phase errors, equalling a delay between input and output. However, delays below certain values can subjectively be claimed to be a zero-latency. This applies to analog routing and mixing, and in our opinion also to RME's Zero Latency Monitoring. The term describes the digital path of the audio data from the input of the interface to its output. The digital receiver of the Fireface UC can't operate un-buffered, and together with TotalMix and the output via the transmitter, it causes a typical delay of 3 samples. At 44.1 kHz this equals about 68 μ s (0.000068 s), at 192 kHz only 15 μ s. The delay is valid for ADAT and SPDIF in the same way.

Oversampling

While the delays of digital interfaces can be disregarded altogether, the analog inputs and outputs do cause a significant delay. Modern converter chips operate with 64 or 128 times oversampling plus digital filtering, in order to move the error-prone analog filters away from the audible frequency range as far as possible. This typically generates a delay of one millisecond. A playback and re-record of the same signal via DA and AD (loopback) then causes an offset of the newly recorded track of about 2 ms. The exact delays of the Fireface UC are:

Sample frequency kHz	44.1	48	88.2	96	176.4	192
AD (43.2 x 1/fs) ms	0.98	0.9	0.49	0.45		
AD (38.2 x 1/fs) ms					0.22	0.2
DA (28 x 1/fs) ms	0.63	0.58	0.32	0.29	0.16	0.15

Buffer Size (Latency)

Windows: This option found in the Settings dialog defines the size of the buffers for the audio data used in ASIO and WDM (see chapter 13).

Mac OS X: The buffer size is defined within the application. Only some do not offer any setting. For example iTunes is fixed to 512 samples.

General: A setting of 64 samples at 44.1 kHz causes a latency of 1.5 ms, for record and playback each. But when performing a digital loopback test no latency/offset can be detected. The reason is that the software naturally knows the size of the buffers, therefore is able to position the newly recorded data at a place equalling a latency-free system.

AD/DA Offset under ASIO and OS X: ASIO (Windows) and Core Audio (Mac OS X) allow for the signalling of an offset value to correct buffer independent delays, like AD- and DA-conversion or the Safety Buffer described below. An analog loopback test will then show no offset, because the application shifts the recorded data accordingly. Because in real world operation analog record and playback is unavoidable, the drivers include an offset value matching the Fireface's converter delays.

Therefore, in a **digital** loopback test a *negative* offset of about 3 ms occurs. This is no real problem, because this way of working is more than rare, and usually the offset can be compensated manually within the application. Additionally, keep in mind that even when using the digital I/Os usually at some place an AD- and DA-conversion is involved (no sound without...).

Note: Cubase and Nuendo display the latency values signalled from the driver separately for record and playback. While with our former cards these values equalled exactly the buffer size (for example 3 ms at 128 samples), the Fireface displays an additional millisecond – the time needed for the AD/DA-conversion. Playback even shows another millisecond added – see Safety Buffer.

Safety Buffer

An additional small Safety Buffer on the playback side only has proven to be very efficient and useful. The Fireface UC uses a fixed additional buffer of 32 samples, which is added to the current buffer size. The main advantage is the ability to use lowest latency at highest CPU loads. Furthermore, the fixed buffer does not add to the latency jitter (see Tech Info), the subjective timing is extraordinary.

Core Audio's Safety Offset

Under OS X, every audio interface has to use a so called *Safety Offset*, otherwise Core Audio won't operate click-free. The Fireface UC uses a safety offset of 16 samples. This offset is signalled to the system, and the software can calculate and display the total latency of buffer size plus AD/DA offset plus 2 x Safety Offset plus Safety Buffer for the current sample rate.

31.3 USB Audio

USB audio is in several ways different from PCI based audio interfaces.

A Fireface UC can achieve a performance similar to a PCI or PCI Express card when used with an optimal PC. Low CPU load and click-free operation even at 48 samples buffer size are indeed possible on current computers. However, using older computers a simple stereo playback will already cause a CPU load of more than 30%.

A computer blocked for a short time – no matter if ASIO or WDM – will lose one or more data packets. Such problems can only be solved by increasing the buffer size (and with this the latency).

The Fireface UC features a unique data checking, detecting errors during transmission via USB and displaying them in the Settings dialog. Additionally the Fireface provides a special mechanism to continue recording and playback in spite of drop-outs, and to correct the sample position in real-time.

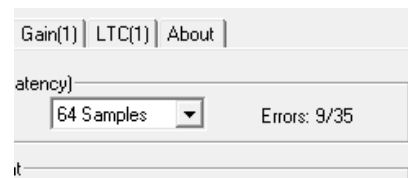

Like any audio interface the Fireface UC should have a data transmission to the computer as undisturbed as possible. The easiest way to guarantee this is to connect it to its own bus, which should be no big problem as most USB 2.0 interfaces are a double bus design. A check in the Device Manager can be done as follows:

- Connect the Fireface UC to a USB port
- Start the Device Manager, choose View Devices by Connection
- Select ACPI x86-based PC, Microsoft ACPI-Compliant System, expand PCI Bus

This branch normally includes two entries of a USB2 Enhanced Host Controller. A USB Root Hub can be seen, which then connects all USB devices, including the Fireface UC. By reconnecting to a different port this view now allows for a check at which of the two controllers the Fireface is connected. With multiple devices it can also be checked if they are connected to the same controller.

Furthermore this information can be used to operate an external USB drive without disturbing the Fireface UC, by simply connecting the drive to the other controller.

Especially with notebooks it can happen that all internal devices and all the sockets/ports are connected to the same controller, with the second controller not used at all. In that case all devices have to use the same bus and interfere with each other.

31.4 DS - Double Speed

When activating the *Double Speed* mode the Fireface UC operates at double sample rate. The internal clock 44.1 kHz turns to 88.2 kHz, 48 kHz to 96 kHz. The internal resolution is still 24 bit.

Sample rates above 48 kHz were not always taken for granted, and are still not widely used because of the CD format (44.1 kHz) dominating everything. Before 1998 there were no receiver/transmitter circuits available that could receive or transmit more than 48 kHz. Therefore a work-around was used: instead of two channels, one AES line only carries one channel with its odd and even samples being distributed to the former left and right channels. By this, you get the double amount of data, i. e. also double sample rate. Of course in order to transmit a stereo signal two AES/EBU ports are necessary then.

This transmission mode is called *Double Wire* in the professional studio world, and is also known as *S/MUX (Sample Multiplexing)* in connection with the ADAT format.

Not before February 1998, Crystal shipped the first 'single wire' receiver/transmitters that could also work with double sample rate. It was then possible to transmit two channels of 96 kHz data via one AES/EBU port.

But *Double Wire* is still far from being dead. On one hand, there are still many devices which can't handle more than 48 kHz, e. g. digital tape recorders. But also other common interfaces like ADAT or TDIF are still using this technique.

Because the ADAT interface does not allow for sampling frequencies above 48 kHz (a limitation of the interface hardware), the Fireface UC automatically uses *Sample Multiplexing* in DS mode. One channel's data is distributed to two channels according to the following table:

Analog In	1	2	3	4	5	6	7	8
DS Signal Port	1/2 ADAT	3/4 ADAT	5/6 ADAT	7/8 ADAT	-	-	-	

As the transmission of double rate signals is done at standard sample rate (Single Speed), the ADAT output still delivers 44.1 kHz or 48 kHz.

31.5 QS – Quad Speed

Due to the small number of available devices that use sample rates up to 192 kHz, but even more due to a missing real world application (CD...), Quad Speed has had no broad success so far. An implementation of the ADAT format as double S/MUX results in only two channels per optical output. There are few devices using this method.

In Quad Speed mode the Fireface UC automatically uses *Sample Multiplexing*. One channel's data is distributed to four channels according to the following table:

Analog In	1	2	3	4	5	6	7	8
DS Signal Port	1/2/3/4 ADAT	5/6/7/8 ADAT	-	-	-	-	-	-

As the transmission of quad rate signals is done at standard sample rate (Single Speed), the ADAT output still delivers 44.1 kHz or 48 kHz.

The SPDIF (AES) output of the Fireface UC provides 192 kHz as Single Wire only.

31.6 AES/EBU - SPDIF

The most important electrical properties of 'AES' and 'SPDIF' can be seen in the table below. AES/EBU is the professional balanced connection using XLR plugs. The standard is being set by the *Audio Engineering Society* based on the AES3-1992. For the 'home user', SONY and Philips have omitted the balanced connection and use either Phono plugs or optical cables (TOSLINK). The format called S/P-DIF (SONY/Philips Digital Interface) is described by IEC 60958.

Type	AES3-1992	IEC 60958
Connection	XLR	RCA / Optical
Mode	Balanced	Un-balanced
Impedance	110 Ohm	75 Ohm
Level	0.2 V up to 5 V _{ss}	0.2 V up to 0.5 V _{ss}
Clock accuracy	not specified	I: ± 50ppm II: 0,1% III: Variable Pitch
Jitter	< 0.025 UI (4.4 ns @ 44.1 kHz)	not specified

Besides the electrical differences, both formats also have a slightly different setup. The two formats are compatible in principle, because the audio information is stored in the same place in the data stream. However, there are blocks of additional information, which are different for both standards. In the table, the meaning of the first byte (#0) is shown for both formats. The first bit already determines whether the following bits should be read as Professional or Consumer information.

Byte	Mode	Bit 0	1	2	3	4	5	6	7
0	Pro	P/C	Audio?	Emphasis			Locked	Sample Freq.	
0	Con	P/C	Audio?	Copy	Emphasis			Mode	

It becomes obvious that the meaning of the following bits differs quite substantially between the two formats. If a device like a common DAT recorder only has an SPDIF input, it usually understands only this format. In most cases, it will switch off when being fed Professional-coded data. The table shows that a Professional-coded signal would lead to malfunctions for copy prohibition and emphasis, if being read as Consumer-coded data.

Nowadays many devices with SPDIF input can handle Professional subcode. Devices with AES3 input almost always accept Consumer SPDIF (passive cable adapter necessary).

31.7 Noise Level in DS / QS Mode

The outstanding signal to noise ratio of the Fireface's AD-converters can be verified even without expensive test equipment, by using record level meters of various software. But when activating the DS and QS mode, the displayed noise level will rise from -109 dB to -104 dB at 96 kHz, and -82 dB at 192 kHz. This is not a failure. The software measures the noise of the whole frequency range, at 96 kHz from 0 Hz to 48 kHz (RMS unweighted), at 192 kHz from 0 Hz to 96 kHz.

When limiting the measurement range from 20 Hz to 20 kHz (so called audio bandpass) the value would be -110 dB again. This can be verified with RME's *DIGiCheck*. The function **Bit Statistic & Noise** measures the noise floor by *Limited Bandwidth*, ignoring DC and ultrasound.

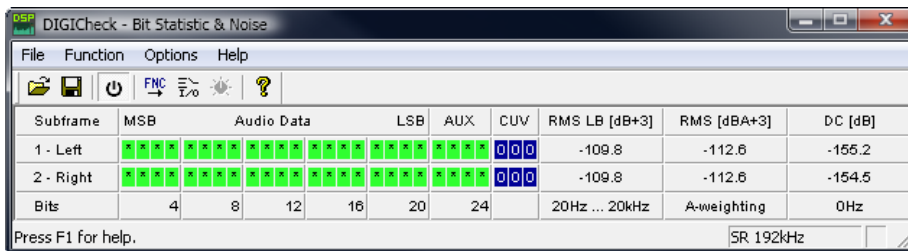

The reason for this behaviour is the noise shaping technology of the analog to digital converters. They move all noise and distortion to the in-audible higher frequency range, above 24 kHz. That's how they achieve their outstanding performance and sonic clarity. Therefore the noise is slightly increased in the ultrasound area. High-frequent noise has a high energy. Add the doubled (quadrupled) bandwidth, and a wideband measurement will show a significant drop in SNR, while the human ear will notice absolutely no change in the audible noise floor.

31.8 SteadyClock

The SteadyClock technology of the Fireface UC guarantees an excellent performance in all clock modes. Thanks to a highly efficient jitter suppression, the AD- and DA-conversion always operates on highest sonic level, being completely independent from the quality of the incoming clock signal.

SteadyClock has been originally developed to gain a stable and clean clock from the heavily jittery MADi data signal (the embedded MADi clock suffers from about 80 ns jitter). Using the Fireface's input signals SPDIF and ADAT, you'll most probably never experience such high jitter values. But SteadyClock is not only ready for them, it would handle them just on the fly.

Common interface jitter values in real world applications are below 10 ns, a very good value is less than 2 ns.

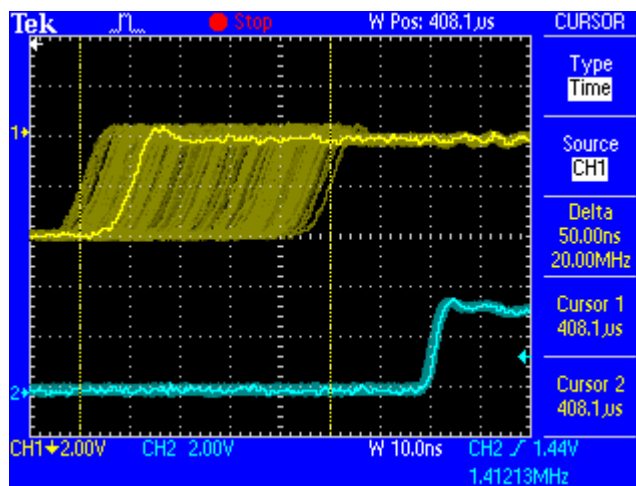

The screenshot shows an extremely jittery SPDIF signal of about 50 ns jitter (top graph, yellow). SteadyClock turns this signal into a clock with less than 2 ns jitter (lower graph, blue). The signal processed by SteadyClock is of course not only used internally, but also used to clock the digital outputs. Therefore the refreshed and jitter-cleaned signal can be used as reference clock without hesitation.

32. Diagrams

32.1 Block Diagram Fireface UC

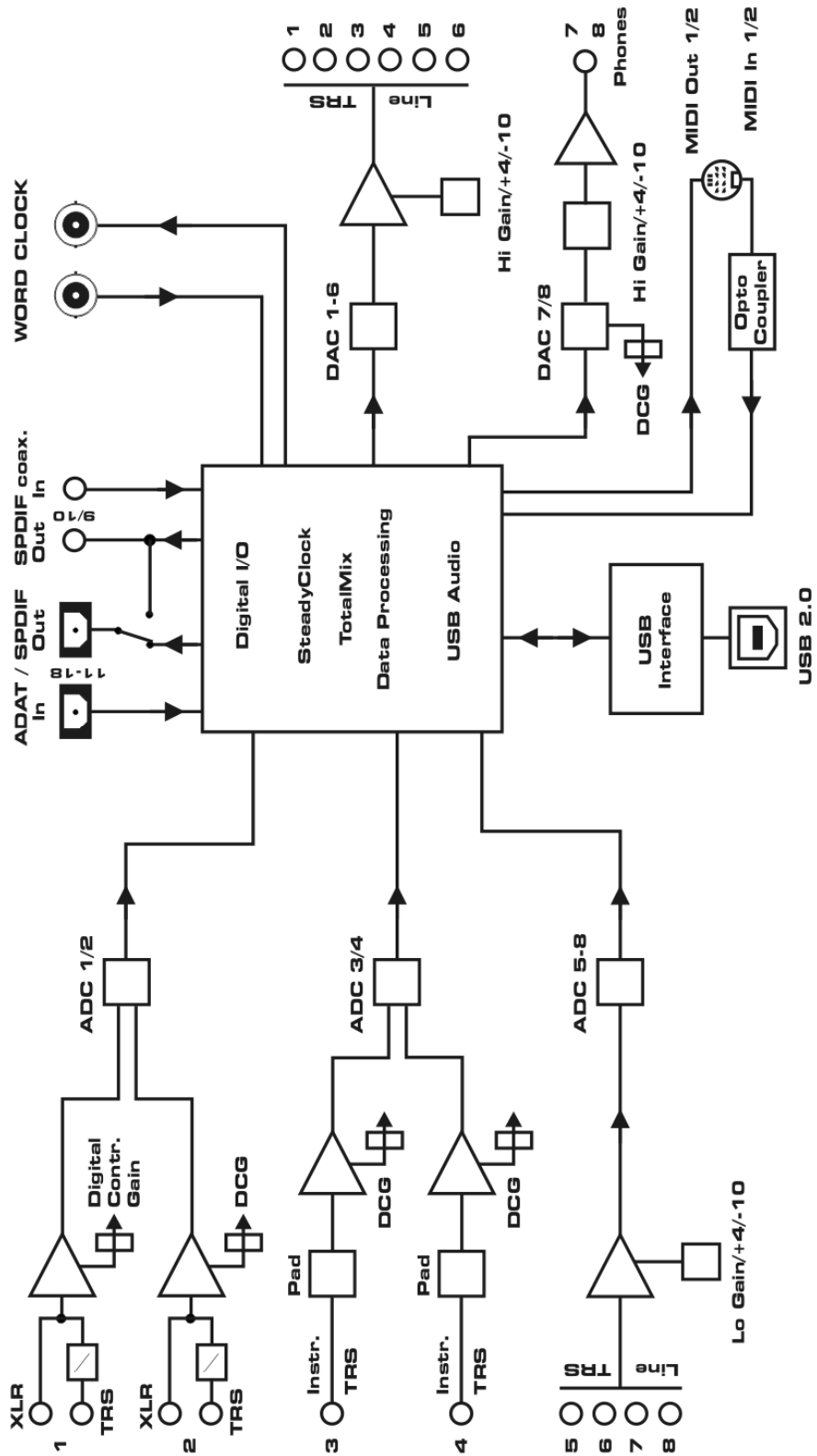

32.2 Connector Pinouts

TRS jacks of analog input / output

The stereo ¼" TRS jacks of the analog inputs and outputs are wired according to international standards:

Tip = + (hot)
Ring = - (cold)
Sleeve = GND

The servo balanced input and output circuitry allows to use monaural TS jacks (unbalanced) with no loss in level. This is the same as when using a TRS-jack with ring connected to ground.

XLR jacks of analog inputs

The XLR jacks are wired according to international standards:

1 = GND (shield)
2 = + (hot)
3 = - (cold)

The inner TRS jack is free of phantom power and wired like the other TRS jacks.

TRS Phones jack

The analog monitor output on the front is accessible through a stereo ¼" TRS jack. This allows a direct connection of headphones. In case the output should operate as Line output, an adapter TRS plug to RCA phono plugs, or TRS plug to TS plugs is required.

The pin assignment follows international standards. The left channel is connected to the tip, the right channel to the ring of the TRS jack/plug.

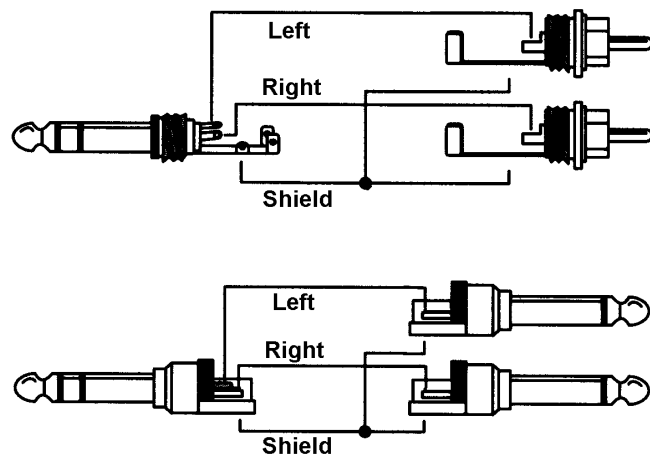

User's Guide



Fireface UC

▶ **Miscellaneous**

33. Accessories

RME offers several optional components for the Fireface UC:

Part Number	Description
-------------	-------------

Optical cable for SPDIF and ADAT operation:

OK0050	Optical cable, TOSLINK, 0.5 m (1.6 ft)
OK0100	Optical cable, TOSLINK, 1 m (3.3 ft)
OK0200	Optical cable, TOSLINK, 2 m (6.6 ft)
OK0300	Optical cable, TOSLINK, 3 m (9.9 ft)
OK0500	Optical cable, TOSLINK, 5 m (16.4 ft)
OK1000	Optical cable, TOSLINK, 10 m (33 ft)

NTCARDBUS	Power supply for Fireface UC. Robust and light-weight switching power supply, 100 V-240 V AC, 12 V 2 A DC.
-----------	--

34. Warranty

Each individual Fireface UC undergoes comprehensive quality control and a complete test at IMM before shipping. The usage of high grade components should guarantee a long and trouble-free operation of the unit.

If you suspect that your product is faulty, please contact your local retailer.

Audio AG grants a limited manufacturer warranty of 6 months from the day of invoice showing the date of sale. The length of the warranty period is different per country. Please contact your local distributor for extended warranty information and service. Note that each country may have regional specific warranty implications.

In any case warranty does not cover damage caused by improper installation or maltreatment - replacement or repair in such cases can only be carried out at the owner's expense.

No warranty service is provided when the product is not returned to the local distributor in the region where the product had been originally shipped.

Audio AG does not accept claims for damages of any kind, especially consequential damage. Liability is limited to the value of the Fireface UC. The general terms of business drawn up by Audio AG apply at all times.

35. Appendix

RME news, driver updates and further product information are available on our website:

<http://www.rme-audio.com>

Distributor: Audio AG, Am Pfanderling 60, D-85778 Haimhausen, Tel.: (49) 08133 / 91810

Manufacturer:

IMM Elektronik GmbH, Leipziger Strasse 32, D-09648 Mittweida

Trademarks

All trademarks, registered or otherwise, are the property of their respective owners. RME, DIGICheck and Hammerfall are registered trademarks of RME Intelligent Audio Solutions. SyncCheck, ZLM, DIGI96, SyncAlign, TMS, TotalMix, SteadyClock and Fireface are trademarks of RME Intelligent Audio Solutions. Alesis and ADAT are registered trademarks of Alesis Corp. ADAT optical is a trademark of Alesis Corp. Microsoft, Windows XP and Windows Vista are registered trademarks or trademarks of Microsoft Corp. Steinberg, Cubase and VST are registered trademarks of Steinberg Media Technologies GmbH. ASIO is a trademark of Steinberg Media Technologies GmbH.

Copyright © Matthias Carstens, 02/2011. Version 1.4

Current driver version: W: 0.966, Mac OS X: 1.50, Firmware 112

Although the contents of this User's Guide have been thoroughly checked for errors, RME can not guarantee that it is correct throughout. RME does not accept responsibility for any misleading or incorrect information within this guide. Lending or copying any part of the guide or the RME Driver CD, or any commercial exploitation of these media without express written permission from RME Intelligent Audio Solutions is prohibited. RME reserves the right to change specifications at any time without notice.

36. Declaration of Conformity

CE

This device has been tested and found to comply with the limits of the European Council Directive on the approximation of the laws of the member states relating to electromagnetic compatibility according to RL2004/108/EG, and European Low Voltage Directive RL2006/95/EG.

FCC

This equipment has been tested and found to comply with the limits for a Class B digital device, pursuant to Part 15 of the FCC Rules. These limits are designed to provide reasonable protection against harmful interference in a residential installation. This equipment generates, uses, and can radiate radio frequency energy and, if not installed and used in accordance with the instructions, may cause harmful interference to radio communications. However, there is no guarantee that interference will not occur in a particular installation. If this equipment does cause harmful interference to radio or television reception, which can be determined by turning the equipment off and on, the user is encouraged to try to correct the interference by one or more of the following measures:

- Reorient or relocate the receiving antenna.
- Increase the separation between the equipment and receiver.
- Connect the equipment into an outlet on a circuit different from that to which the receiver is connected.
- Consult the dealer or an experienced radio/TV technician for help.

RoHS

This product has been soldered lead-free and fulfils the requirements of the RoHS directive.

ISO 9001

This product has been manufactured under ISO 9001 quality management. The manufacturer, IMM Elektronik GmbH, is also certified for ISO 14001 (Environment) and ISO 13485 (medical devices).

Note on Disposal

According to the guide line RL2002/96/EG (WEEE – Directive on Waste Electrical and Electronic Equipment), valid for all european countries, this product has to be recycled at the end of its lifetime.

In case a disposal of electronic waste is not possible, the recycling can also be done by IMM Elektronik GmbH, the manufacturer of the Fireplace UC.

For this the device has to be sent **free to the door** to:

IMM Elektronik GmbH
Leipziger Straße 32
D-09648 Mittweida
Germany



Shipments not prepaid will be rejected and returned on the original sender's costs.