



Apogee Element Series

User's Guide v1.0 October, 2016



Contents

Overview	3
Introduction	3
Package Contents	4
Element 24 Panel Tour	5
Element 46 Panel Tour	5
Element 88 Panel Tour	5
Setup	6
System Requirements	6
Download & Install Element Software package	6
Connect Element to Your Computer	7
If connecting a Second Element	7
Update Element's Firmware	8
Element Control	9
Element Control Mac Software	9
Essentials Window	10
Primary Window	10
Toolbar	11
System Sidebar	11
Device Sidebar	12
Channel Section	13
Mixer Section	15
Monitor/Output Section	16
Hover Help	17
Menu Bar Menus	18
Apogee Control iOS App	19
iOS App Toolbar	20
Analog Input Settings	20
Monitor Output Settings	21
Snapshots & Examples	22
Getting Started Snapshot Template	23
How Element Control Input Channels appear in your Recording Program:	24
How Element Control Outputs work with your Recording Program:	25
How to get a separate mix to the headphones than from the speaker outputs:	26
Essentials Snapshot Template	28
Direct Monitoring Snapshot Template	29
Using the Direct Monitor Snapshot Template with your Recording Program	31
Full Functionality Snapshot Template	32
Vocal Overdub Snapshot Template	33
A/D Expander Snapshot Template	37
Working with a Multiple Element Interface Setup	38
Connecting a Multiple Element Interface System:	38
The Multiple Element Interface System in Use	39
Additional Support	40

Overview

Introduction

Legendary Sound Quality. The Power of Thunderbolt. Elegant Simplicity.

Apogee's Element 24, 46 and 88 are Thunderbolt audio I/O boxes for Mac. The Element Series takes the best of cutting-edge Apogee gear like Symphony I/O Mk II, Ensemble Thunderbolt and Groove and puts it into simple form factors. With streamlined hardware features and advanced software control, the Element series delivers ultimate recording quality and performance at unprecedented prices.

The Elements of Excellent Audio



Analog to Digital Conversion

A high-quality A/D converter is critical for capturing every detail of your recordings into your computer. The Element series features some of the best Apogee A/D conversion. Recording through an Element ensures you will minimize unwanted noise and maximize the signal quality. Your tracks will sound amazing and mixing your project will be easier.



Microphone Preamps

Whether you are recording powerful drums, dynamic vocals or delicate strings, you need a premium mic preamp to capture the finest details of the performance. The Element Series mic preamps feature Apogee's Advanced Stepped Gain Architecture™. This analog circuit is designed to dynamically optimize across a gain range of 0-75dB to provide superior bandwidth and low distortion.



Digital to Analog Conversion

With a high-quality D/A converter, you will hear more definition in each track and virtual instrument. This clarity makes it easier for you to make precise adjustments and achieve the ideal balance when mixing your music. When you listen to your sessions through an Element, tracks will blend more harmoniously and mixing will be easier. The high end will sound crisp and clear and the low end will be tight and well defined.

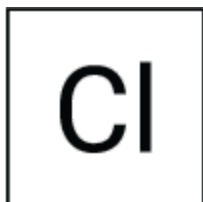

Clocking

An audio interface relies on a clock source like an orchestra relies on a conductor. A digital audio clock provides a timing signal to all the parts of a digital audio system so that each part of the AD/DA process may be synchronized. Element has its own built-in clock source and provides professional Word Clock IN and OUT for syncing with other digital audio gear. Use Element as the master clock to take advantage of Apogee's superior built-in clocking technology.



Thunderbolt Connectivity

The Element Series Thunderbolt driver offers incredible low-latency performance (1.41 ms round-trip) and rock-solid stability. Apogee's custom driver uses less of your computer's CPU power with the help of Direct Memory Access (DMA) technology. This allows you to run more plugins and monitor through your DAW at a low buffer setting. Element's low latency driver means you don't have to choose between power and speed.

Package Contents

The following items are included with your Element Series Interface

Apogee Element 24

Universal Power Supply with standard 3 pin-IEC cable
Quick Start Guide
Warranty Booklet

Apogee Element 46

Universal Power Supply with standard 3 pin-IEC cable
Quick Start Guide
Warranty Booklet

Apogee Element 88

Rack mounting kit
Universal Power Supply with standard 3 pin-IEC cable
Quick Start Guide
Warranty Booklet

Register your product

- Access Apogee's expert Technical Support for free
- Receive important product update information by email
- Take the Customer Satisfaction Survey for a chance to win Apogee gear!

Register Now: www.apogeedigital.com/support/register



Element 24 Panel Tour



Element 46 Panel Tour



Element 88 Panel Tour

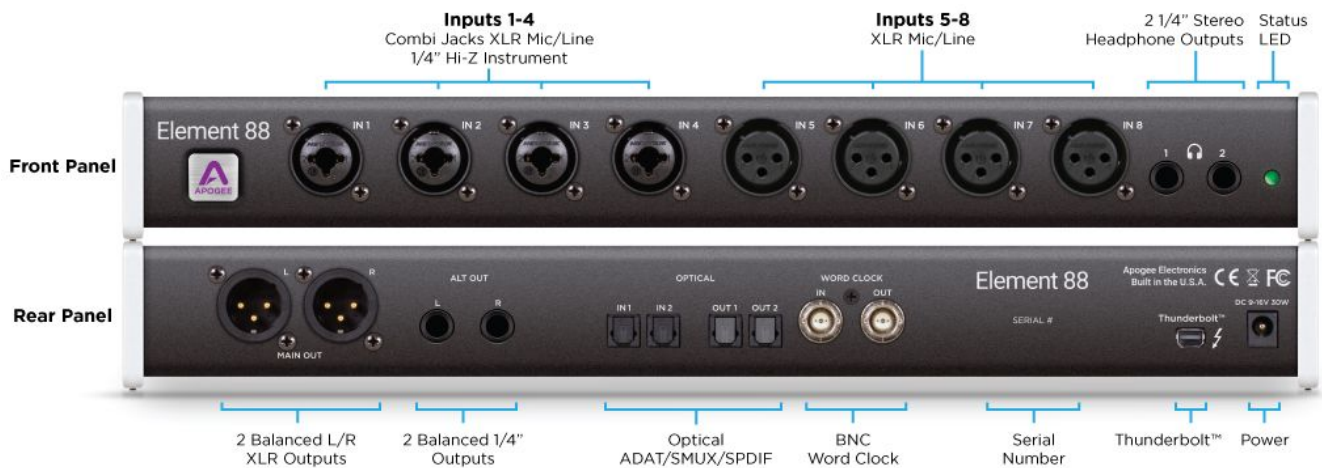

Setup

System Requirements

- Mac OS X 10.10 or greater
- Thunderbolt™-equipped Mac
- 4GB minimum RAM, 8GB Recommended

Download & Install Element Software package

Before Element will work with the computer, special software must be installed. Always get the latest version of the software from the apogee website:

www.apogeedigital.com/support/element

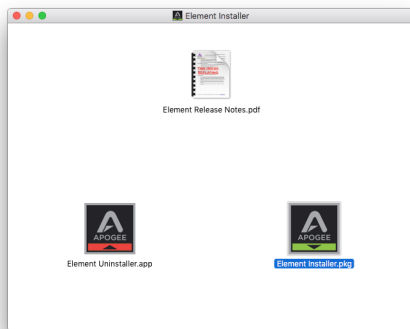

The download comes in the form of a .dmg file. Open it to view the contents. Inside you will find three items:

- *Element Release Notes.pdf*
- *Element Uninstaller.app*
- *Element Installer.pkg*

Double-click to launch the Element Installer.pkg. A dialog box will appear with a series of steps to proceed. Follow the prompts to complete the installation. You will be required to restart your computer.

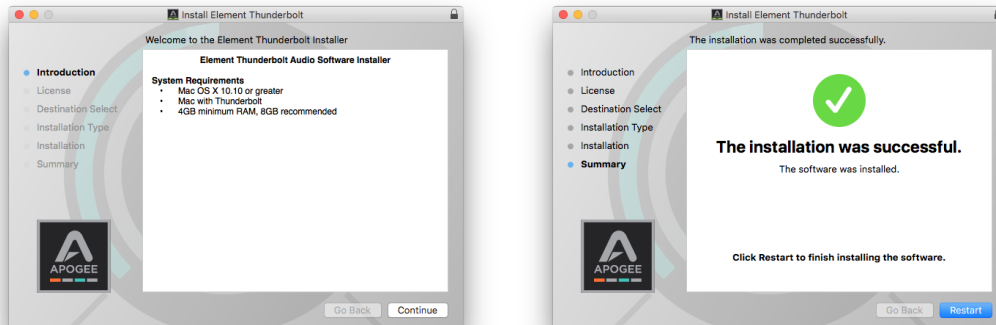

As a result of the software install:

- *Element Control software is placed in the Mac's Applications folder*
- *When connected, the Element Thunderbolt interface appears as an audio input/output device in Mac System Preferences > Sound*
- *Element Firmware Updater.app is placed in the Mac's Applications > Utilities folder.*

Connect Element to Your Computer

1. Connect the Power Supply to Element.



2. Connect Element to your Mac using a Thunderbolt cable.



If connecting a Second Element

1. Connect the Power Supply to Element
2. Connect Element to a second Thunderbolt port on your Mac.
3. Connect optical cables from the Optical Out of one Element, to the Optical In of the second Element.
 - If second unit is Element 24 & 46 - Two optical cables required
 - If connecting two Element 88 units - Four optical cables required

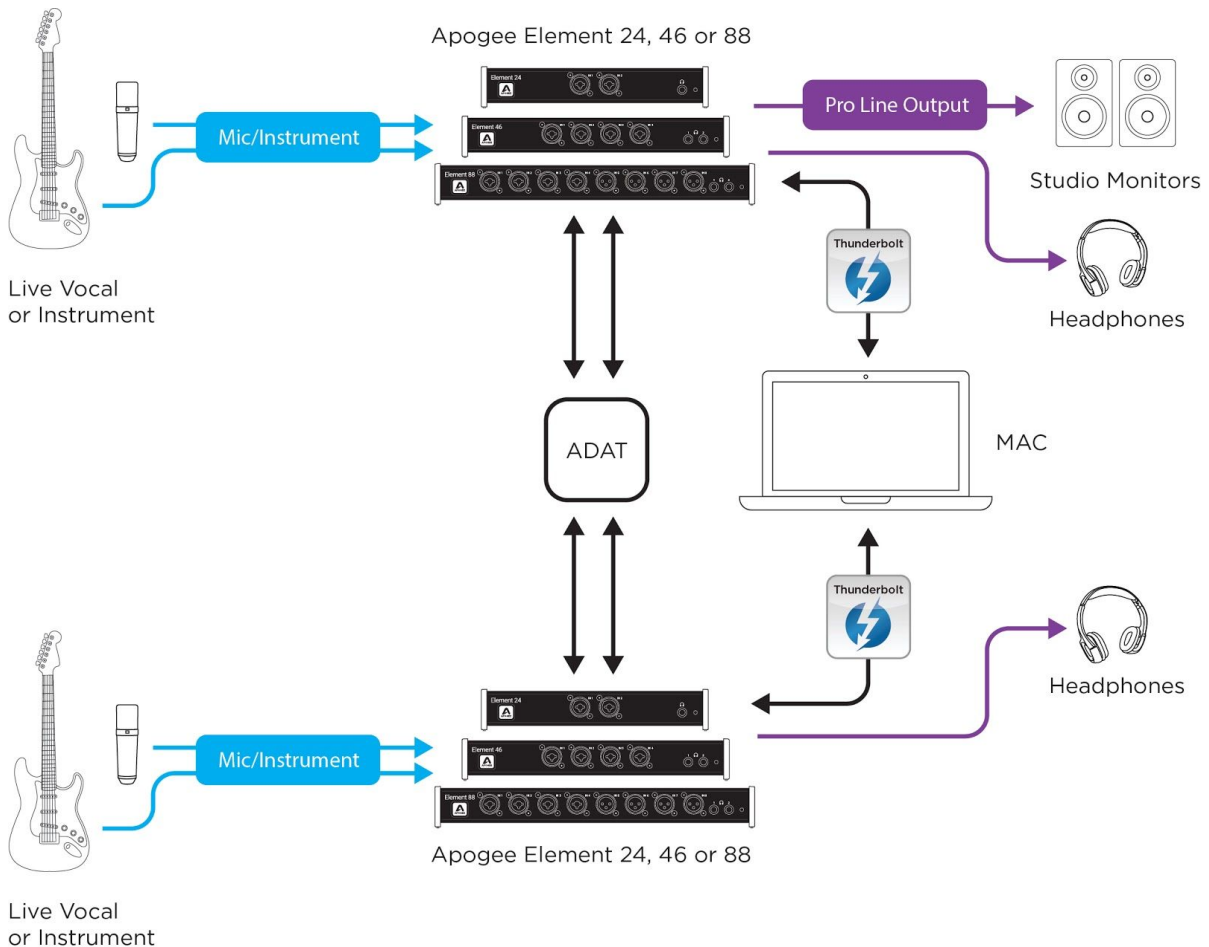

Update Element's Firmware

When first connecting Element to your computer, you may be prompted to update the Firmware:



1. Click Update, or manually open the Element Firmware Updater.app from your computer's Applications > Utilities folder.

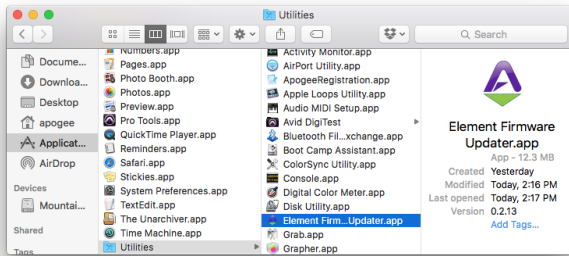

2. Make sure only one Element is connected to the Mac. Then click Start Update.

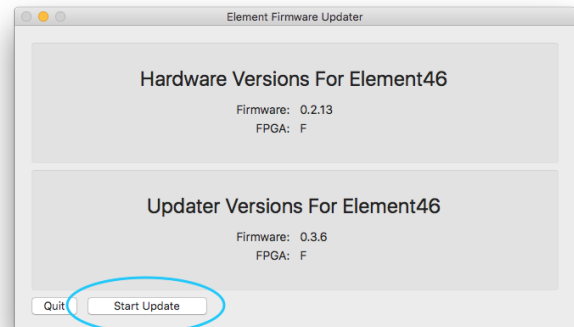

3. Follow any prompts that may appear.

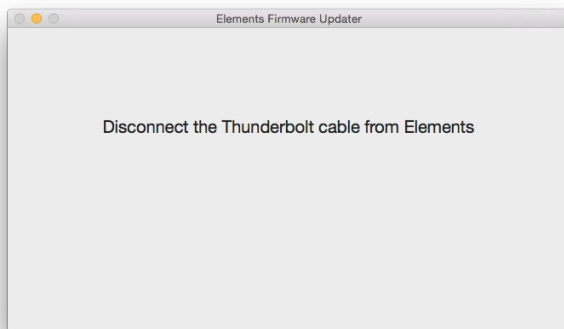

4. When it says Element is up to date, you can quit the updater.

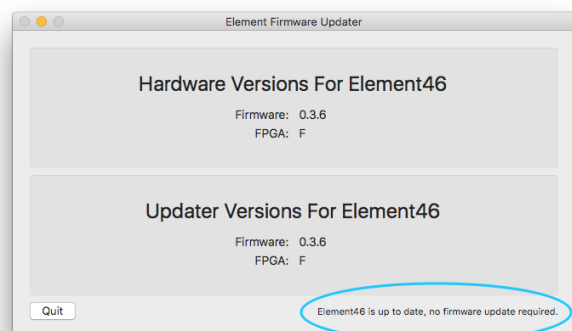

Element Control

Control of your Apogee Element Thunderbolt interface is available through a Mac software app, or an iOS control app. Each provides it's own unique set of controls and features.

Element Control Mac Software

When Element Control for Mac software is opened, you are presented with a Snapshot Template chooser.

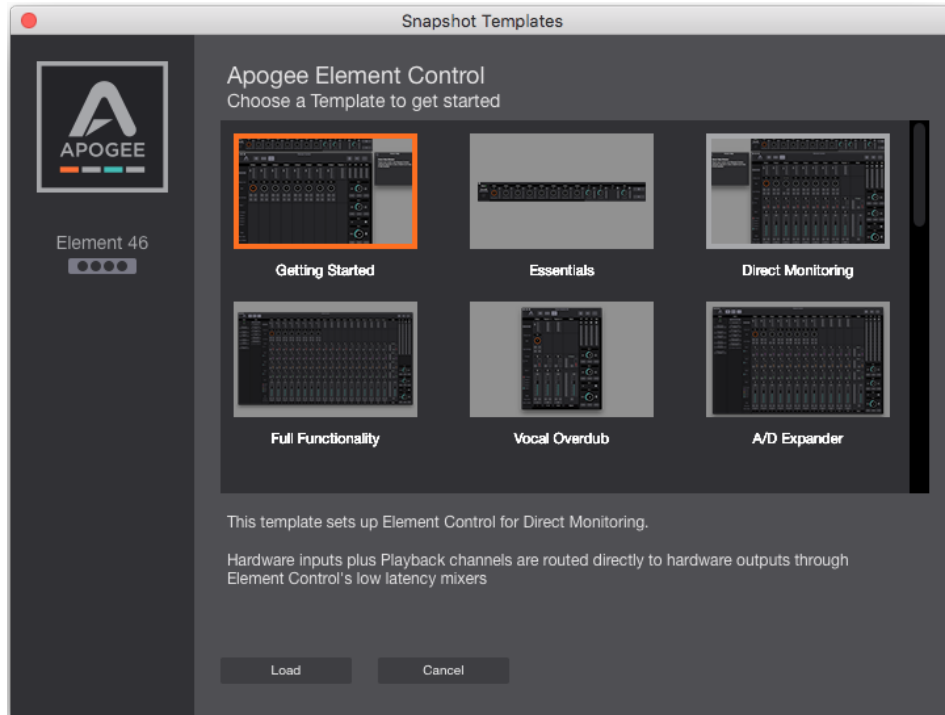

Each Snapshot Template is a starting point that provides the most common feature set needed for various workflows. These default Snapshot Templates and examples of their use are explained further on page 21. A snapshot can be further customized to your specific needs and saved as a user-snapshot. Here is an explanation of all the features and components of Element Control:

Element Control consists of three windows:

1. Essentials
2. Primary
3. Hover Help

Essentials Window

This window provides simple and compact controls for Input Channels and Outputs. It's orientation can be changed between vertical and horizontal so that it can be placed to the side or end of your recording software.



1. **System Status Display** - This displays the status of the connected Apogee Element hardware.
 - **Green** - System is ready: Hardware is connected and recognized, and the digital clock is locked to the Clock Source.
 - **Red** - System not ready. Either the hardware is not connected, or the digital clock is not locked to the Clock Source.
2. **Orientation Button** - Switches the Essentials window between horizontal and vertical view.
3. **Analog Input Channels** - Provides settings for the analog inputs.
 - The buttons at the bottom correspond to the Input Channel Settings: Phantom Power (48V), Group (G), Soft Limit (SL), and Polarity Invert (\emptyset)
4. **Outputs** - Headphones and speaker outputs settings are provided.
 - The buttons at the bottom correspond to the Output controls: Mute (M), Diminish (D), Sum-to-Mono (Σ)
5. **Clear Meters** - Clear the Peak or Hold indicators from the level meters.
6. **Mute All** - Mutes Headphones and Speakers outputs of the Element Thunderbolt interface. To unmute, click the individual headphone or speaker mute buttons.

Primary Window

All features and settings of the Element Thunderbolt interface can be controlled from the Primary window. It is broken down into several sections:

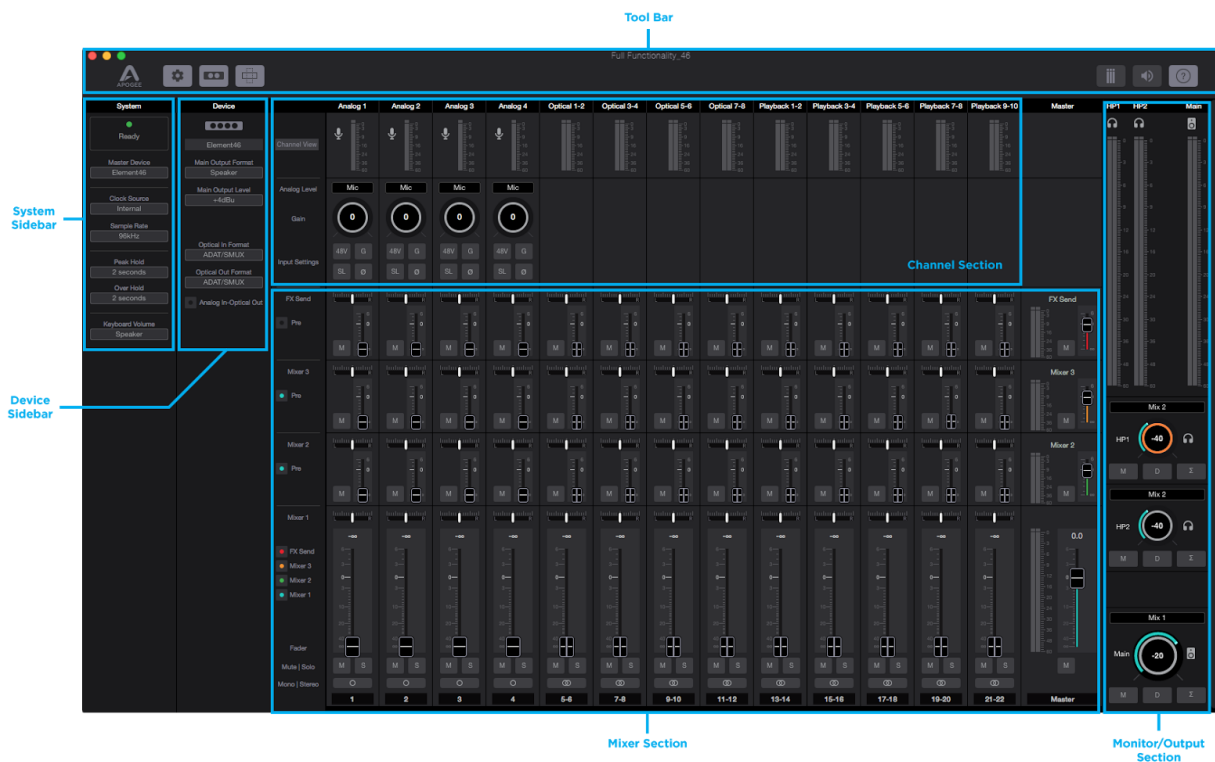

Tool Bar

The Tool Bar is always visible at the top of the Primary window. It provides the ability to show/hide the System Sidebar, Device Sidebar, Essentials window, Remote window and Hover-Help window. It also has buttons for Clear Meters and Mute All outputs.

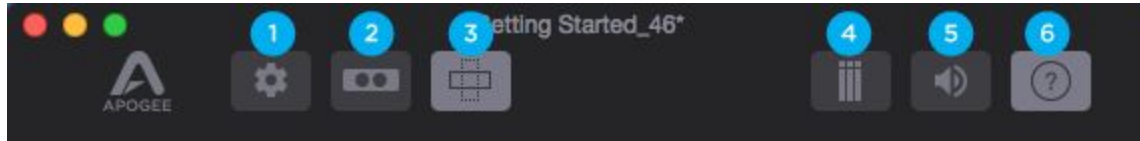

- | | |
|--------------------------|-----------------|
| 1. System Sidebar Button | 4. Clear Meters |
| 2. Device Sidebar Button | 5. Mute All |
| 3. Essentials Button | 6. Hover Help |

System Sidebar

Provides System-wide settings that apply to your recording system as a whole.

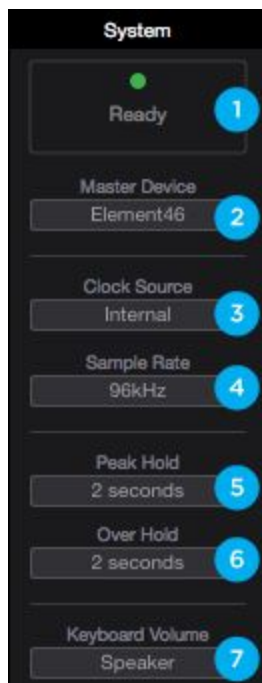

- System Status Display** - This displays the status of the connected hardware.
 - Green** - System is ready: Hardware is connected and recognized, and the digital clock is locked to the Clock Source.
 - Red** - System not ready. Either the hardware is not connected, or the system is not locked to the Clock Source.
- Master Device** - When two Element interfaces are connected, select one as the Master Device. The Master Device acts as the clock master, is listed first in your DAW's hardware I/O assignment, and includes Output Format functionality on the Main outputs.
- Clock Source** - Selects the system clock source for Element. The following sources may be selected:
 - Internal**: Element is clocked from its internal crystal
 - Word Clock**: Element is clocked from an external word clock signal connected to the rear panel BNC input
 - Optical**: Element is clocked from a digital audio input.
- Sample Rate** - Selects Element's sample rate. In some cases this setting may be overridden by software running on the computer (i.e. When a DAW session project is open).
- Peak Hold** - Sets the time that peak indications are held on the level meters.
- Over Hold** - Sets the time that over indicators are held on the level meters.
- Keyboard Volume** - The audio system may be configured so that the Mac keyboard volume controls set the output level of Element's speaker or headphone outputs.

Device Sidebar

The Device Sidebar provides settings that are specific to the Element interface connected to the Mac.



1. **Device ID** - Identifies the hardware connected to the Mac system.
 - Clicking this button causes the displayed hardware to flash it's status light for three seconds.
2. **Main Output Format** - Changes the output to suit what is being connected to the XLR Main output jacks:
 - **Speaker** - Use this setting when connecting speakers to the Main XLR hardware outputs
 - **Line** - Use this setting when connecting a mixer or other device with its own volume control to the Main XLR hardware outputs
3. **Main Output Level** - Selects the line-level reference for the XLR Main output jacks:
 - Choose **+4dBu** when connecting to "pro" gear with inputs at a +4dBu nominal level.
 - Choose **-10dBV** when connecting to "semi-pro", hi-fi, or musical instrument gear with inputs at a -10dBV nominal level.
4. **Optical In and Out Format** - Sets the digital audio protocol for the optical connectors. Match the optical format to that of the connecting device:
 - **SPDIF**: The two-channel SPDIF audio format is transmitted or received through the selected port's In or Out connections. This format is capable of utilizing a maximum sample rate of 96kHz.
 - **ADAT/SMUX**: The multi-channel ADAT or SMUX format is transmitted or received through the selected ports. Capable of 8 channels of digital I/O at sample rates 44.1kHz - 48kHz, and 4 channels of digital I/O at sample rates 88.2kHz - 96kHz.
 - **On Element 88, setting the sample rate to 88.2kHz or 96kHz activates the second set of optical I/O. This provides 4 more channels for a total of 8 channels of digital I/O.*
5. **Analog In-Optical Out** - Enable direct routing from Analog inputs to Optical outputs. When checked, all analog inputs are passed individually to the Optical outputs.
 - On Element 24, signal only appears on ADAT output 1-2.
 - On Element 46, signal only appears on ADAT output 1-4.
 - On Element 88, signal appears on all ADAT output channels.

Note: When Optical Out Format is set to SPDIF, only inputs 1-2 are transmitted to the optical output 1-2.

Channel Section

This portion of the Primary Window displays Channels for Analog input, Digital input, and Playback from audio software.

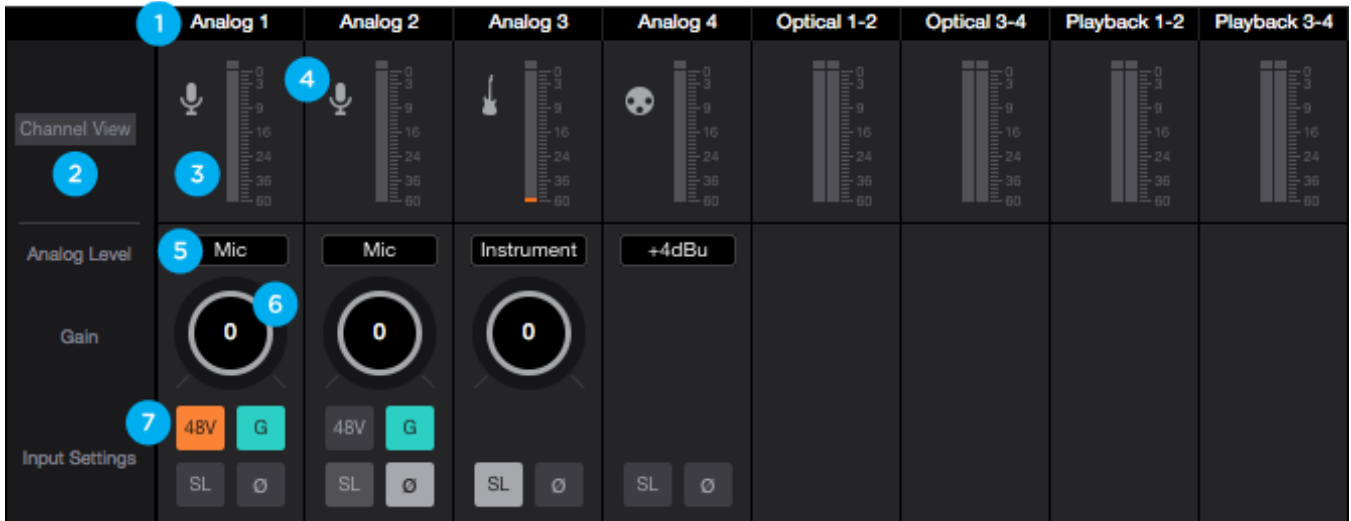

1. **Channel Top Label** - Indicates the channels source. Can be renamed by clicking the label and typing a user-customized label. To restore to the default text, delete the text and press “Return” on your keyboard.

**These labels are transmitted to your DAW*

2. **Channel View Button** - Show the Channel View pop-up to view/hide various channels.





** Channels are disabled when hidden so audio signal will not pass.*

- **Analog Input Channels** - Corresponds to the physical analog input connections on your Element interface.
- **Optical Input Channels** - Corresponds to the physical optical input connections on your Element interface.
- **Playback Channels** - Corresponds to the virtual signal path from your Mac’s software outputs.



3. **Input Channel Level Meter** - Shows the post-gain digital signal level coming into the channel.
4. **Input Icon** - Shows the input type selected from the Analog Level drop-down
5. **Analog Level** - Use this drop down menu to choose the analog level for each A/D conversion channel.
 - Choose **Mic** when connecting microphones or direct boxes, or any devices that needs to run through a microphone preamplifier. -XLR Input only
 - Choose **Inst** when connecting a guitar or keyboard, or any high impedance (Hi-Z) instrument to the 1/4” input (balanced TRS or unbalanced TS). The signal is sent through a Hi-Z to Low-Z conversion circuit before sent through the microphone preamplifier circuit.
 - Choose **+4dBu** when connecting to “pro” gear, such as an external mic pre, compressor, or EQ, with outputs at a +4dBu nominal level.
 - Choose **-10dBV** when connecting to “semi-pro”, hi-fi, or musical instrument gear with outputs at a -10 dBV nominal level.
6. **Gain Control** - Use to adjust the gain of the microphone preamp. Not available when the input is set to +4dBu or -10dBV



7. **Input Settings** - Provides options for the various inputs:

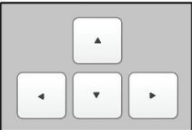

- : Use this button to enable 48 volt phantom power on the corresponding Analog In channel. Condenser mics require 48 volt phantom power to operate.
-  **Group**: The input gain controls of adjacent odd-even channels are adjusted simultaneously. Any level offsets that exists before inputs are grouped will be preserved after a group is chosen.
-  **Soft Limit**: Select "On" to engage. This option begins to attenuate transient peaks at a threshold of -4dBfs.
-  **Polarity Invert**: Use this button to invert the polarity of the input signal.

Apple Keyboard Navigation Tips

Use the Arrow keys to change Analog input and output settings;



Press   to scroll the orange focus ring through analog inputs and outputs.

  to raise or lower the level highlighted with the focus ring.

Use the volume keys (F10, F11 and F12) to set the level of the Speaker or Headphone output.



Mixer Section

The mixer section provides several Direct Monitor mixers, and a special FX Send mixer for workflows that utilize the low-latency Direct Monitoring features of your Element Thunderbolt interface.



- Mixer 1** - Signal from each channel can be sent through this mixer by raising the corresponding Mixer 1 Channel Fader.
 - This mixer's Master signal can then be selected as a source for the Headphones or Speaker outputs, providing a low-latency direct monitoring signal path.
 - This mixer can also be sent back into the computer as a separate stereo input available in your DAW.
 - The faders on this mixer affect the fader send signal of Mixer 2, 3 and FX Send when the Pre Fader button is not engaged.
 - Mixers 2, 3, 4*** - Signal from each channel can be sent through these mixers by raising the individual Mixer 2, 3, or 4 Channel Fader.
 - This mixer's Master signal can then be selected as a source for the Headphones or Speaker outputs providing a low-latency direct monitoring signal path.
- *Note:*
 Element 24 = 2 mixers available
 Element 46 = 3 mixers available
 Element 88 = 4 mixers available
- FX Send** - Signal from each channels can be sent through this mixer by raising the individual FX Send Channel Fader.
 - This Mixer is sent back into the computer where it shows up as an extra stereo input available in your DAW. By using this input on an Aux track that has a Reverb or Delay or other effects plugin, effects can be applied to a Direct Monitoring situation which would otherwise be completely dry of effects.

4. Pre Fader Button

- When engaged, the channel signal from the mixer 2, 3, or FX Send mixer is sent to that mixer's Master fader based only on that mixer's channel fader level. This signal level is not affected by the position of the Mixer 1 fader (Pre-fader).
- When not engaged (Post-fader), the channel signal from this mixer will change based on the Mixer 1 fader position. In other words, moving the Mixer 1 fader on this same channel will alter the signal level going to the mixer 2, 3 or FX Send mixer master.

5. Mixer View buttons - View or Hide mixers using this button.

**Mixers are always ACTIVE. A mix will continue working even when hidden.*

6. Channel Fader - Set the level of the channel signal in the mixer master stereo output.

7. Mixer Channel Pan Control - Set the left-right placement of the channel signal in the mixer master stereo output.

- Option-click to reset the pan to center (0) or Option+Command-click to set all pans in that mixer to center (0).

8. Channel Mute button - Cut the signal routing to the mixer stereo output. Command-click to cut all channels

9. **Channel Solo button** - Mute all channels that do not have this solo button engaged in this mixer. Command-click to solo all channels.

Note: Engage Solo-Safe mode on a channel by Control-Clicking the Solo button on a channel. This prevents this channel from being muted when another channel in the mixer has solo engaged.



A solo-safe engaged track will display a colored "S" within the Solo button

10. **Channel Mono/Stereo button** - Set the channel for a mono or stereo signal path. When set to stereo, odd-even adjacent channels are combined.
- To group input settings set each channel's Input Gain to 0dB, push the Group button, and then set the channel to Stereo.
 - To adjust a stereo channels individual input's settings, use the arrow buttons that appear next to the Analog Level Setting.

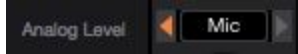

11. **Channel Aux Label** - This secondary label is a convenient way to enter session-specific information, such as the performer whose input appears on the channel. This label is not transmitted to the audio software (DAW).

Monitor/Output Section

The Monitor/Output Section is where you select what you hear in the outputs, and control the volume of the various outputs. The Output Level Meters are also a useful diagnostic tool to see if signal should be present at the various outputs.

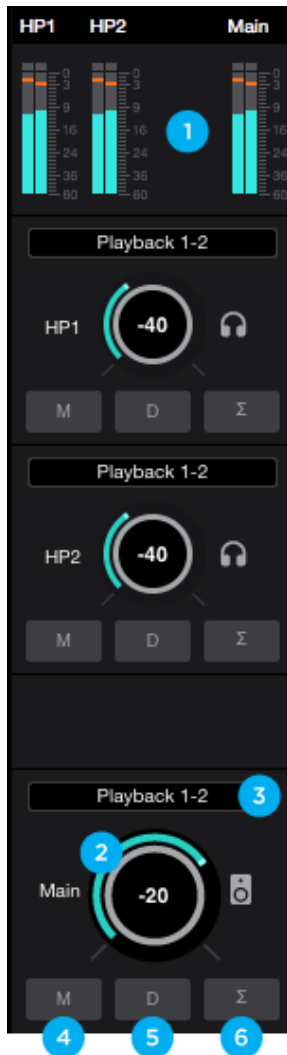

- Output Level Meters** - Displayed the output level. Is not affected by the output level control.
- Output Level Control** - Set the listening level of the Main and Headphone outputs.
- Output Source Selector** - Selects the sound source for each output. The options are:
 - Playback** - Sends a playback channel stereo signal directly to this output, bypassing all mixers.
 - Mix or FX Send** - Send the stereo signal from this mixer's Master to this output
- Output Mute button** - Mutes the output
- Output Dim button** - Reduces the output listening level by -15dB
- Sum-To-Mono button** - Collapse left and right signals to mono at the output. This combined signal is sent through both Left and Right Outputs and is useful for verifying the mono-compatibility of a stereo mix.

Hover Help

For specific information about Element Control's features, open the Help window and hover your Mac's pointer above each setting to see a helpful summary.

Menu Bar Menus

Element Control Menu

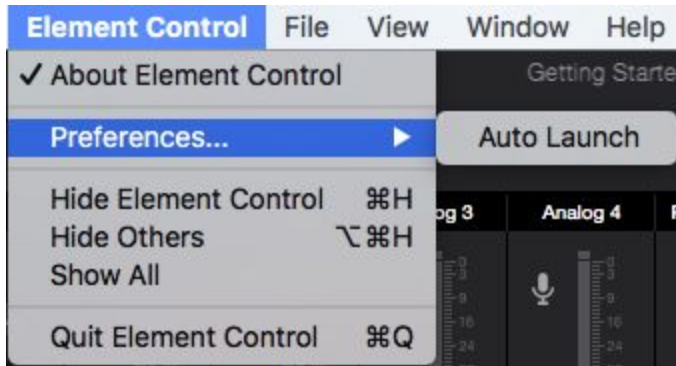

About Element Control - Choose this menu item to display version information for all hardware connected and software elements installed on your Mac.

Preferences > Auto Launch - Choose this menu item to launch Element Control when an Element Thunderbolt interface is connected to the computer.

Hide Element Control - Choose this menu item to hide the Maestro application

Hide Others - Choose this menu item to hide all other open applications

Show All - If any open applications have been hidden, choose this menu item to reveal all open applications

Quit Element Control - Choose this menu item to quit Element Control

File Menu

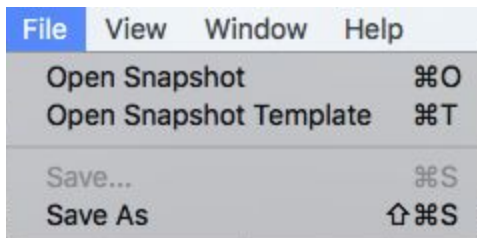

Open Snapshot - Choose this menu item to open a user-saved snapshot template file on your computer.

Open Snapshot Template - Choose this menu item to open the Snapshot Template Chooser window.

Save - Choose this menu item to save a user-customized Snapshot file to a location on your computer.

Save As - Choose this menu item to save a customized Snapshot file in a new name or new location on your computer.

View Menu

View	Window	Help
System Settings		⌘F
Device Settings		⌘D
Enter Full Screen		

System Settings - Choose this menu item to open the System Settings sidebar

Device Settings - Choose this menu item to open the Device Settings sidebar

Enter Full Screen - Choose this menu item to expand Element Control to fill the display screen.

Window Menu

Window	Help
Minimize	⌘M
Zoom	
Bring All to Front	
Essentials	⌘1
✓ Primary	⌘2
✓ Hover Help	⌘3
Hover Help Window	
✓ Window	

Selecting an item in the **Window Menu** switches to a view of that selection.

Help Menu

Help
Search <input type="text"/>
Element Support Online

Use the **Search** Field to search for a specific menu item.

Element Support Online - Select this menu item to be taken to the Apogee website's Support page for Element.

Apogee Control iOS App

Many of the features and settings of the Apogee Element Thunderbolt interface can be controlled by the free Apogee Control iOS app. Here's how it works:



1. Open the App Store app on your iPad, iPhone, or iPod Touch and search for Apogee Control.
2. Download and open the Apogee Control app and the "Connect to Device" screen will appear.
3. Your Apogee Element interface will appear in the "Available Interfaces" list if:
 - Your iOS device is connected to the same WiFi network as your Mac
 - The Element Driver Software has been installed on this Mac computer
 - The Element Interface is powered on and connected to your Mac computer
5. Select your Element Interface from the list of Available Interfaces

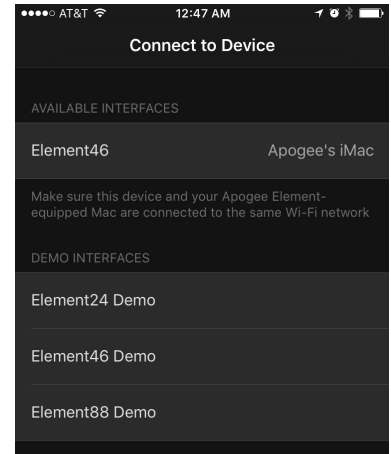

6. A message will appear on your Mac: Click Allow.

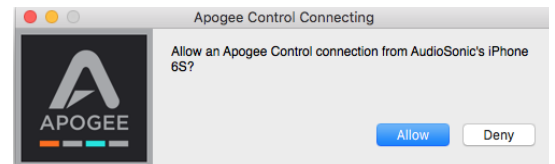

7. The main Control screen will appear. It is separated into three sections:
 - Toolbar
 - Analog Input settings
 - Monitor Output settings

iPhone

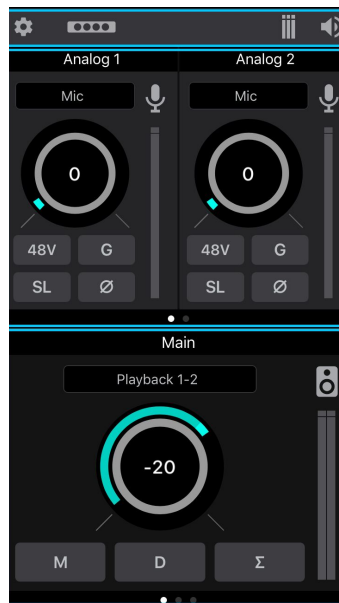

iPad



iOS App Toolbar

Preferences Devices Clear Meters Mute All Outputs



Preferences - Opens the Preferences Menu

Prevent Screen Lock - When engaged, the iOS device's screen will not automatically turn off while the Control app is open.

Devices - Opens the Connect to Device Menu.

Clear Meters - Clears any Peak Hold or Over Hold indicators on the level meters.

Mute All Outputs - Engages Mute on all speaker and headphones outputs. These mutes must be manually disengaged.

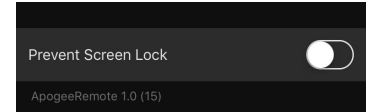

Analog Input Settings

Provides options and controls related to the analog inputs of your Apogee Element Thunderbolt Interface

Input Source

- **Mic** - XLR input is sent through the microphone preamp
- **Instrument** - 1/4" input is sent through a Hi-Z to Low-Z circuit then to the microphone preamp
- **+4dBu/-10dBV** - Live level signal from XLR input bypasses preamp circuit

Gain - Drag your finger up or down on the gain circle to adjust the Input Gain



48V - Toggles phantom power on/off



G - Groups channels into stereo pairs



SL - Soft Limit attenuates transient peaks of the analog input at a threshold of -4dBfs before the signal is sent to the A/D converter.



- Inverts the input signal's polarity

Input Icon - The icon provides visual indication of the type of Input Source selected

Input Level Meter - Shows the input signal strength after going through the preamp circuit.



Navigation

- Use your finger to swipe left or right to page to additional analog inputs

Monitor Output Settings

Provides option and controls related to the Main and Headphones outputs of your Apogee Element Thunderbolt interface.

Output Source Selector - Selects the sound source for this output.

The options are:

Playback - Sends a playback channel stereo signal directly to this output, bypassing all mixers.

Mix or FX Send - Send the stereo signal from this mixer's Master to this output

Output Mute button - Mutes the output

Output Dim button - Reduces the output listening level by -15dB

Sum-To-Mono button - Collapse left and right signals to mono at the output.

This combined signal is sent through both Left and Right Outputs and is useful for verifying the mono-compatibility of a stereo mix.



Output Level Meters - Displayed the output level. Is not affected by the output level control.

Output Level Control - Set the listening level of the hardware output.



Navigation

- Use your finger to swipe left or right to page to additional analog outputs

Snapshots & Examples

When Element Control software is first opened, you are presented with a Snapshot Template chooser.

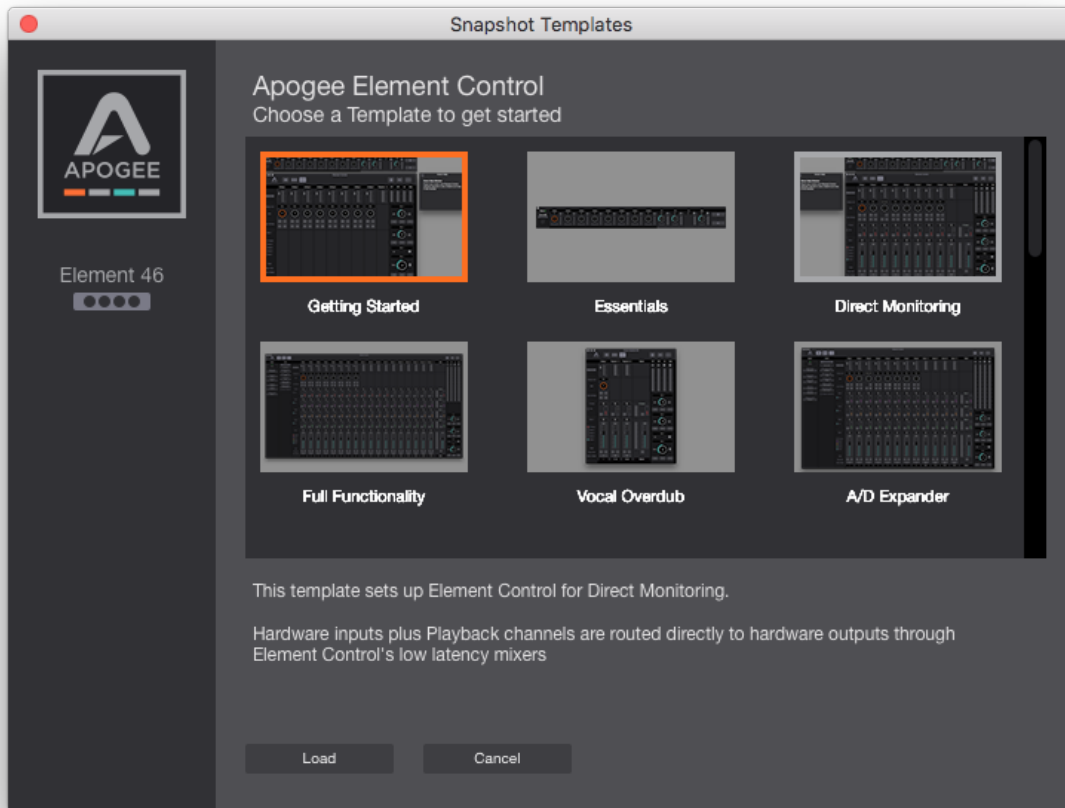

The following section will explain and explore these default Snapshot Templates in depth, with use-cases demonstrating how each would be used in a recording program (DAW) like Logic Pro X.

Getting Started Snapshot Template

This Snapshot Template provides simple input settings in the Input Channel section, a single stereo playback channel for audio playing from audio software such as iTunes or your DAW, and output settings for dealing with your speaker and headphone outputs. This represents the most common and familiar use of an audio interface.

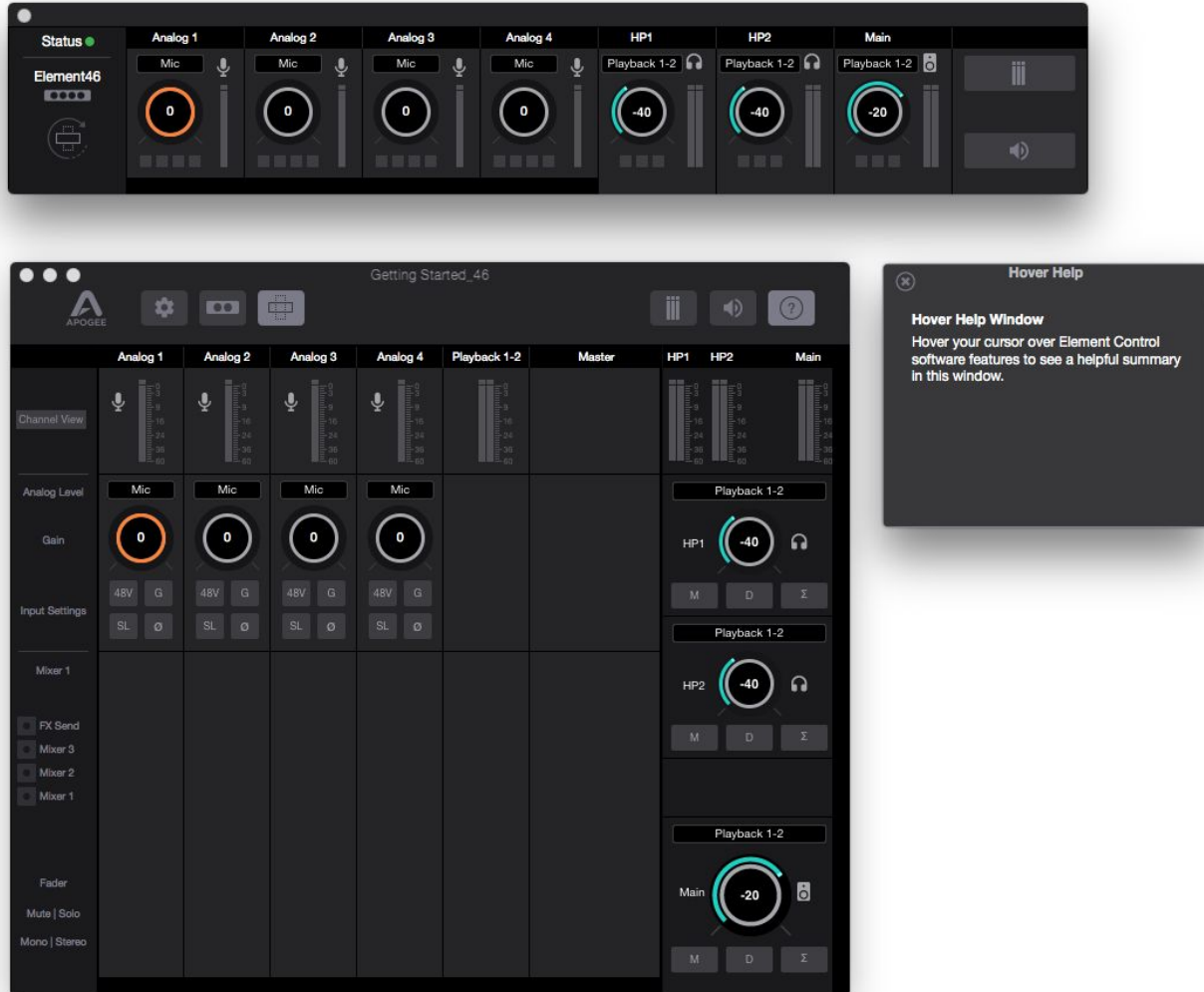

This template provides:

Primary Window -

- **All Analog Input Channels** - Provides settings for adjusting & controlling the analog inputs as well as input level meters to show the strength of incoming signal.
- **One Playback Channel** - For audio signal being played from an audio application on your Mac.
- **No Mixer Section** - Mixers are hidden in this Snapshot. Use of the Mixers will be explained later in this guide.
- **Monitor Section** - Provides settings & controls for headphones and speaker outputs. You can choose the sound source for each output allowing some sounds to come through some outputs and other sounds to come out of other outputs.

Essentials Window - Provides the same settings and controls as the Analog Input Channels and Monitor Section.

Hover Help - Hover your Mac's pointer above each setting of Element Control software to see a helpful summary.

Each of these sections dictate how and where audio signal flows between the Element Thunderbolt Interface's hardware connections and the recording software (DAW) tracks and channels on your computer. Lets analyze that signal flow:

How Element Control Input Channels appear in your Recording Program:



The Analog Input Channels of Element Control allow you to select the type of input you are using: Mic, Instrument, or Line Level +4dBu/-10dBV.

You may activate phantom power (48V) for condenser mics, Group (G) channels together in stereo pairs, turn on Soft-Limit (SL), or invert the polarity (\emptyset) of any of these input channels.

In your recording program, any audio track you create can be set to record these Analog Inputs.



In this example Logic Pro X project, four audio tracks have been created with each track set to Input 1, 2, 3, and 4 respectively. In this way, each Element 46 interface audio Input Channel corresponds with the four tracks created in Logic Pro X.

You can think of your audio signal as flowing from the analog inputs of your Element interface, through the Element Control software's Analog Input Channels, then into the Logic software.

Note: With the Audio Device control feature in Logic Pro, you can see that the settings made on these Input Channels in Element Control are matched/mirrored by the Audio Device section of the Logic Pro X mixer.

The audio signal then flows through these Logic tracks until it eventually exits through the Logic Output channels.

From there the signal flows back into the Element Control software:

How Element Control Outputs work with your Recording Program:



Signal from the Stereo Output of Logic Pro X appears in Element Control's Playback 1-2 channel.

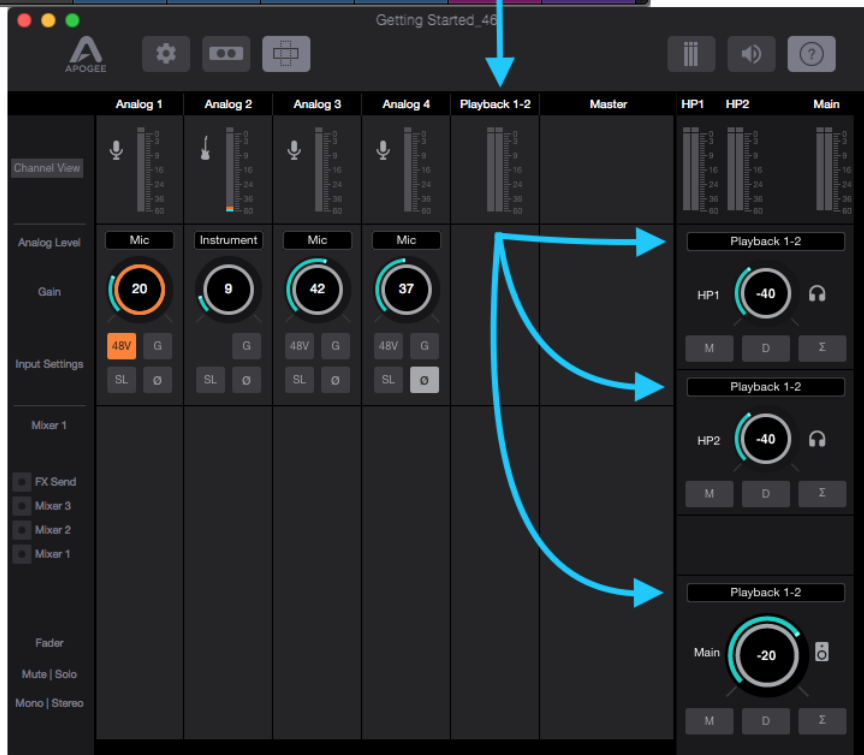

This Playback 1-2 signal will flow to the Element interface's outputs because the audio source for the Headphone and Main speaker outputs is set to Playback 1-2.

How to get a separate mix to the headphones than from the speaker outputs:

To do this, you first have to create an aux mix in your Recording Program.



In Logic, create a Send to a Bus on one of your tracks **1**

This automatically creates an Aux track in your Logic Pro X Mixer **2**

- In Pro Tools and other DAW's you must manually create an Aux Track

Set this Aux track to output via Playback 3-4 **3**.



Next, go to Element Control and click Channel View **1**.

Click Playback 3-4 to show that playback channel **2**.



Set the Headphones output to Playback 3-4 to send this signal to your headphones output.

The Main monitor outputs are still set to Playback 1-2 and play audio from Logic's Stereo Out master track.

Essentials Snapshot Template

This Snapshot Template is the same as the Getting Started Snapshot Template but only the Essentials Window is displayed. This represents the simplest layout of the Element Control software. It provides controls for only Inputs and Outputs. All other settings are disabled or hidden:



All Analog Input Channels and Monitor output controls are represented in the Essentials bar. The small buttons below the Gain controls correspond to the Input Settings 48V, G, SL, and \emptyset . The buttons under the Output Volume controls correspond to the output buttons M, D and Σ .

For convenience, the Essentials bar can be converted to a vertical orientation via the Orientation Button. In this way, the Essentials bar can be placed next to your DAW software for easy access.

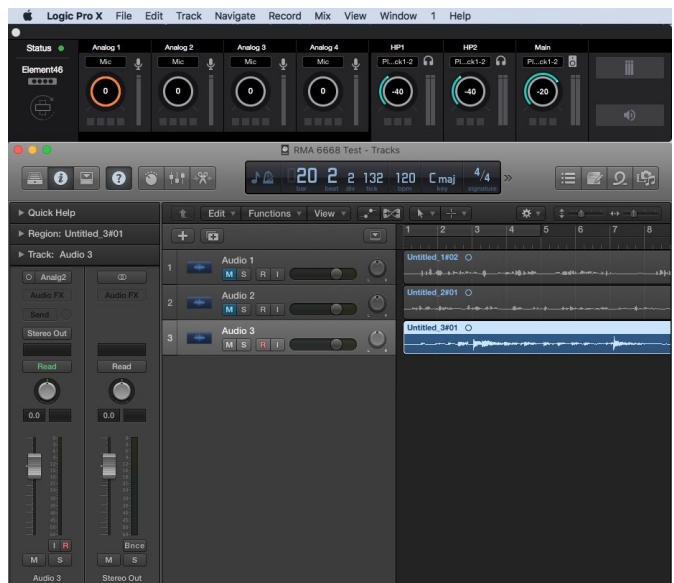
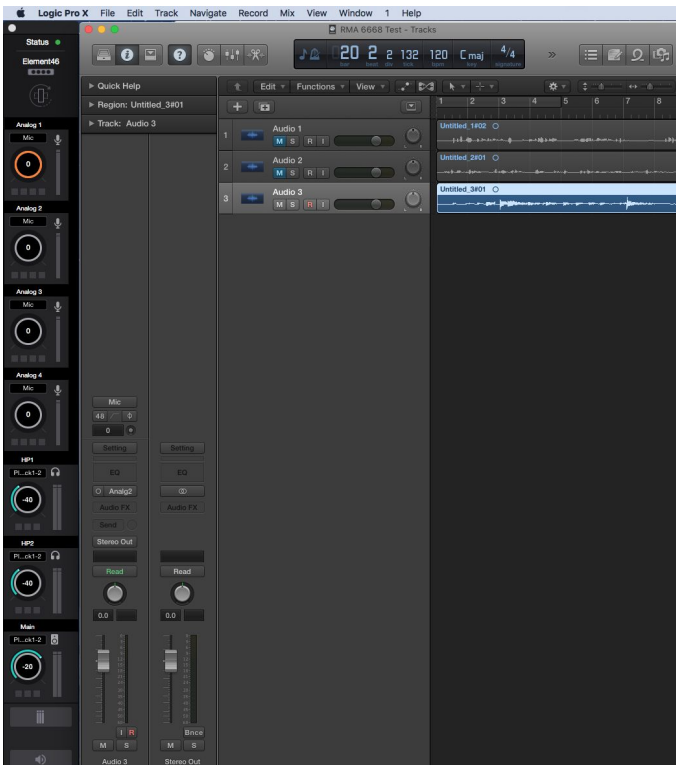

Direct Monitoring Snapshot Template

This Snapshot Template is perfect for users who do not want to open a DAW in order to listen to their inputs. It does this by setting the headphones and speaker outputs to “Mix 1”. In this way, any channel that has the Mixer 1 fader raised will be heard. This snapshot is also for users who want the lowest latency monitoring possible, and can't achieve a low enough buffer in their DAW for software monitoring to be acceptable.



This template provides:

- **All Analog Input Channels** - Provides settings for adjusting & controlling the analog inputs as well as input level meters to show the strength of incoming signal.
- **One Playback Channel** - For audio signal being played from an audio application on your Mac.
- **Mixer 1 Showing** - Mixer 1 is the key to direct monitoring and is used to send signal from the various channels directly to the Monitor Section.
- **Monitor Section** - All the main and headphone outputs are set to Mix 1

Lets analyze the signal flow:

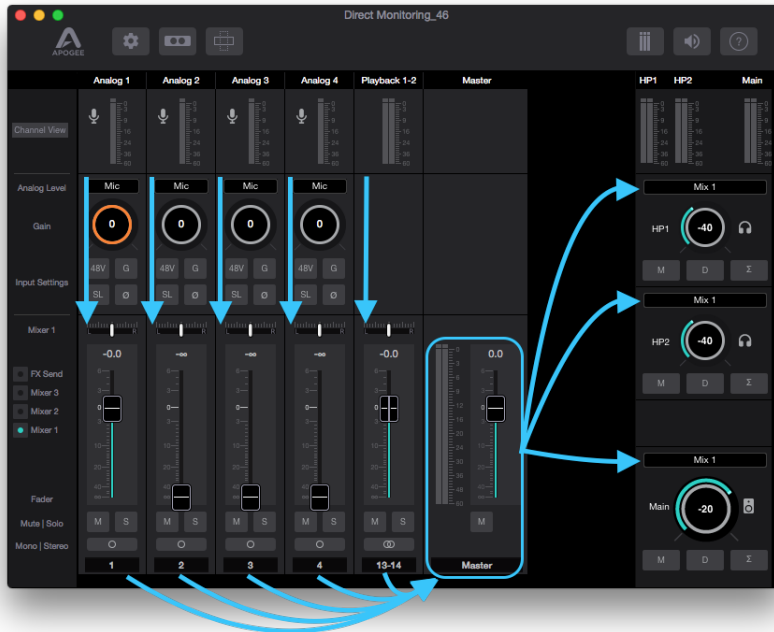

Any signal from the Input Channel Section must go through the Mixer 1 fader before it will be heard in the outputs that are set to "Mix 1". This has a few benefits:

- An analog or digital input can be heard directly through the interface rather than having to setup an audio track with software monitoring in a recording program first.
- Provides a very low-latency monitoring path.
- Direct input signals can be mixed with audio from Playback channels such as your recording program or iTunes or YouTube, etc.

Note that signal from the Input Channels go to your recording software (DAW) at the same time they are being sent to the Mixer 1. In this way, this Direct Monitoring Snapshot can be used with a DAW that is unable to achieve a low enough buffer size to get the latency delay to be acceptable. Here's how you would set up this Snapshot Template with a recording program like Logic:

Using the Direct Monitor Snapshot Template with your Recording Program

1. Setup an audio track in Logic.
 - Make sure input monitoring on that track is turned off because you are direct monitoring through Element Control instead.
2. Record to that track.
3. Setup a second audio track in Logic that also has input monitoring turned off.
4. Record the second track. You will be able to hear the first track as you record.
5. Adjust the Mixer 1 channel faders to control the volume of direct input you are recording vs playback of already existing recording playing back from Logic.

The signal flow would look like this:

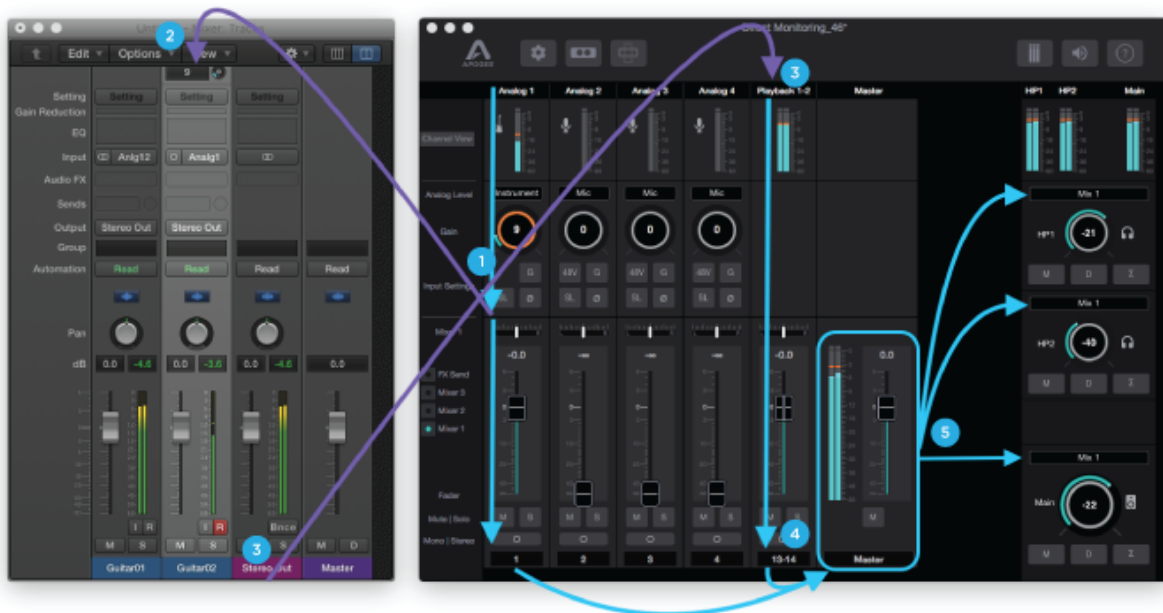

1. Input signal from Analog 1 is sent to both Logic and the Mixer 1
2. In Logic, the signal is routed to an Audio track for recording. Input Monitoring on this track is off.
3. Playback from Logic is sent to Element Control's Playback 1-2 Input Channel.
4. Both the direct signal from Analog 1 Input channel, and Playback 1-2 Input Channel are mixed together to the Mixer 1 Master.
5. Mixer 1 feeds the Main and Headphones outputs.

This same Snapshot Template can be used in other recording programs like Pro Tools, Cubase, Ableton Live, etc. by using the same principles shown in this example.

Full Functionality Snapshot Template

For the user that wants a “god-view”, this Snapshot Template has all side-panels, mixers, and channels visible.

Note: All outputs are set to “Mix 1” in this Snapshot like the Direct Monitoring Snapshot Template. Therefore you must raise the Mixer 1 channel faders to hear anything in the outputs.



Vocal Overdub Snapshot Template

This Snapshot Template is conceived for an overdubbing recording session. At this stage in the recording process, a recording project is typically full of tracks and plugins which may require your I/O Buffer to be set to a large size. Because software input monitoring with such a large buffer would result in too much latency, this snapshot is designed for Direct Monitoring a single input, but using Element Control's FX Send to apply your DAW's reverb to the Low Latency (Direct Monitoring) mixer inputs.

Notice that in this Snapshot Template:

- The Mixer 1 and FX Send are both displayed
- The Outputs are set to "Mix 1" for direct monitoring
- There is a single analog input channel active, and two playback input channels active.

Here's how this is set up using Logic Pro X:

1. In Logic Pro X > Preferences > Audio > General, uncheck the boxes for "Software Monitoring" and "Input monitoring only for focused track, and record-enabled tracks"

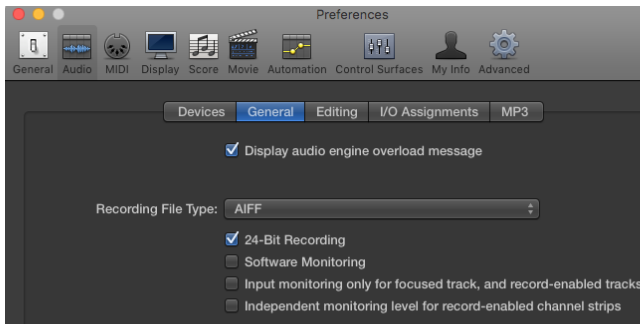

2. Create an Audio track. Set the input to Analog 1.



Note: For the purposes of this guide, having the Mixer visible will make things easier. To do this:

- Go to the View Menu > Show Mixer.

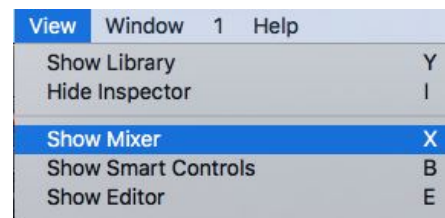

Setup a standard reverb send and return for this audio track:



3. In the “Sends” section of the Audio track, create a Bus send.

Set the Bus level to 0.0dB.



When you create the Bus send, Logic will automatically create an Aux track with that bus selected as the input.

Note: You will need to manually create the Aux track in other DAW's like Pro Tools, Cubase, Live, etc.

4. In the new Aux input track, instantiate your favorite reverb plugin.

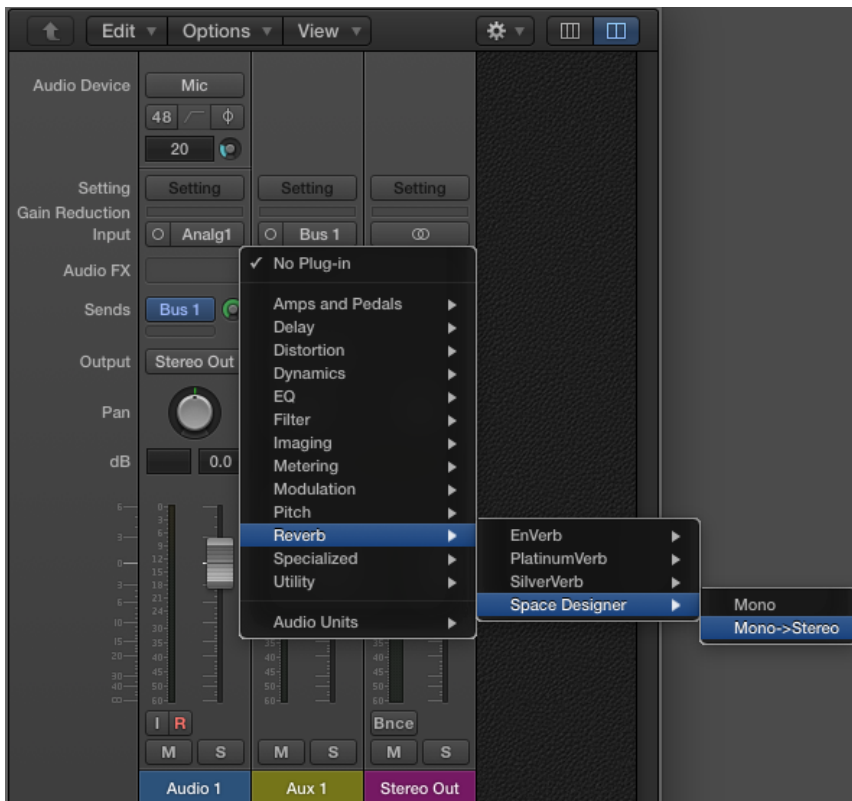

Raise the Aux 1 channel fader to 0.0dB.



At the end, your Logic Project will look like this:

This creates a dual-path signal flow:

- **Path 1** happens when Recording
- **Path 2** happens when Playing back that recording

Path 1:

Audio from Element Control Analog 1 input is sent to Logic's Audio 1 track for recording.

This Analog 1 Input signal also goes via the FX Send to Logic Aux 2 input, which then Bus sends to the Aux with the Reverb plugin.

The Reverb Aux's output is routed to the stereo output of the Logic session which returns to the Element Control mixer via Playback 1-2.

Element Control Mixer 1 combines the Analog 1 signal with the reverb from Playback 1-2 and the mix of these is sent to the Main and Headphone outputs.

Path 2:

When playing back the recording in Logic's Audio track 1, the Bus 1 Send on this track sends the signal to the Aux with the Reverb Plugin applied.

This Audio playback track and Reverb Aux track is mixed in Logic's Mixer and sent to the Stereo Out, where it arrives in Element Control via Playback 1-2.

Element Control Mixer 1 then sends the Playback 1-2 signal on to the Main and Headphone outputs.

For both Path 1 & 2:

- Since the bus send level to the Reverb plugin in Logic is the same for recording and playback, the reverb sound doesn't change from recording to playback.
- Adjust the Bus 1 sends for a proper level to the Reverb Aux track, then adjust the Reverb Aux track fader until the desired amount of reverb is heard.



A/D Expander Snapshot Template

This Snapshot Template facilitates the use of your Element Firewire interface as a simple Analog to Digital Converter (A/D). This snapshot is useful when wanting to send digital audio to a Digital Mixer, or separate Audio Interface. In this way, you can utilize the excellent Apogee Preamps and Converters through another digital audio system.

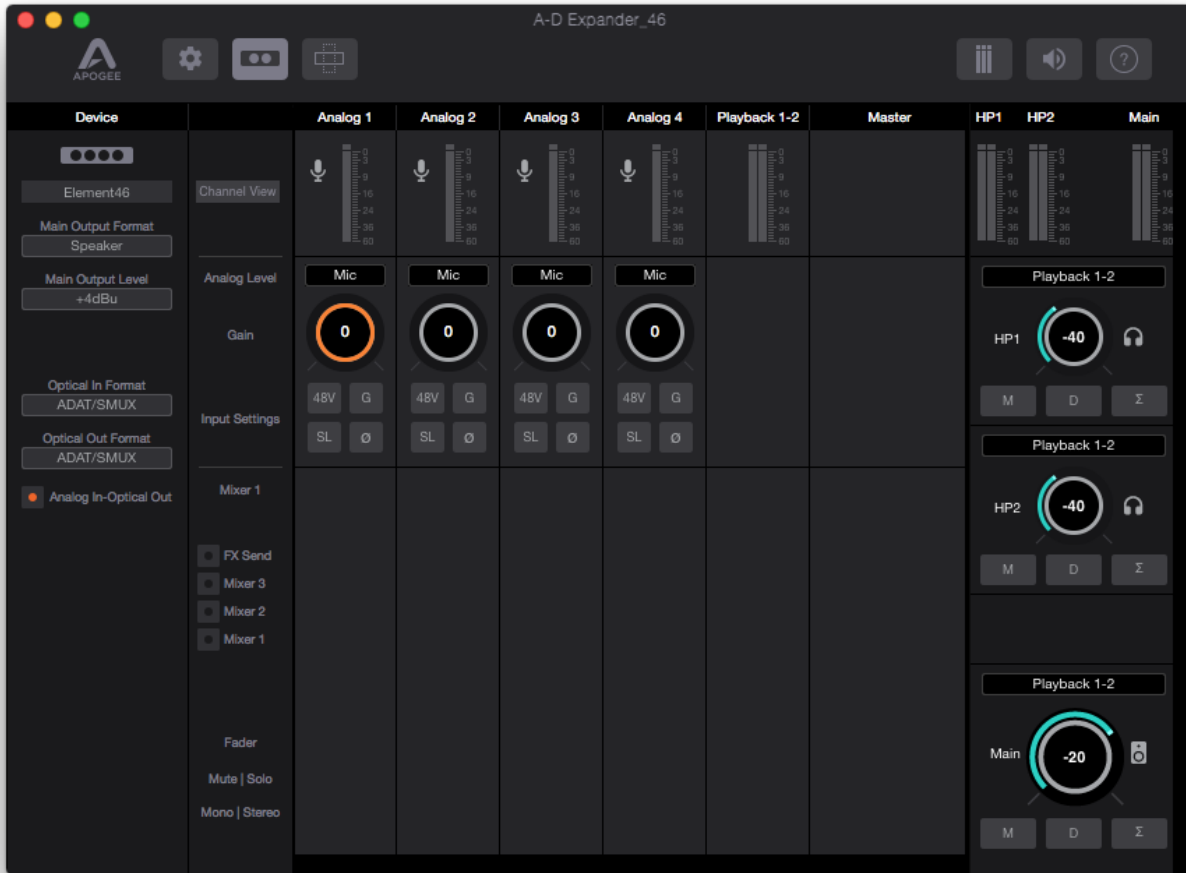

The Individual Analog inputs are sent directly to the ADAT optical outputs.

- Element 24 - Analog input 1 - 2 > ADAT output ch 1 - 2
- Element 46 - Analog input 1 - 4 > ADAT output ch 1 - 4
- Element 88 - Analog input 1 - 8 > ADAT output ch 1 - 8

Working with a Multiple Element Interface Setup

The connection of any two Element Series interfaces is supported in any desired order, for a system with up to 16 analog inputs, 8 line outputs, and 4 headphone outputs.

Connecting a Multiple Element Interface System:

To connect multiple Element interfaces:

- A Mac with at least two Thunderbolt ports is required
- Element interfaces may be connected directly to your Mac or after dual-port Thunderbolt peripherals
- The Optical I/O of both interfaces is used for digital clocking and audio signal bussing between the interface's low latency (direct) monitoring mixers. Thus, Optical I/O is not available for external connections in a Multiple Element Interface System

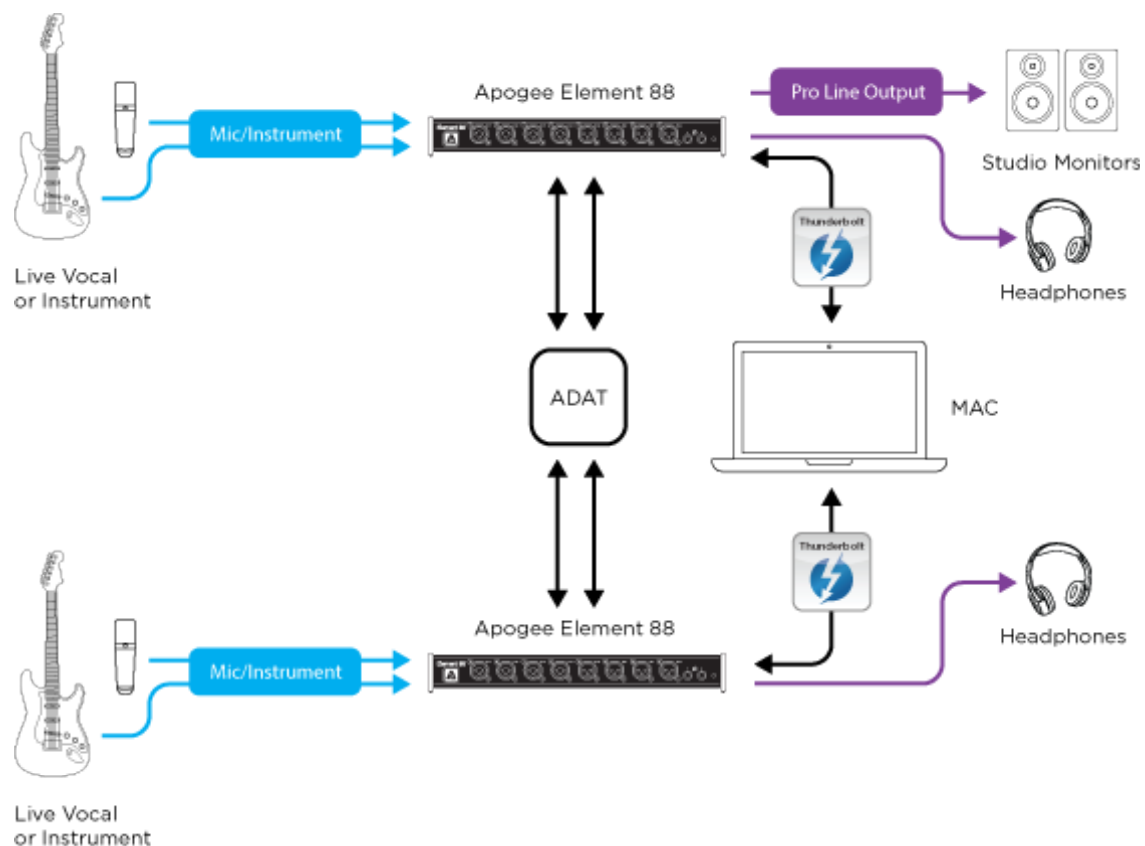

The Multiple Element Interface System in Use

When a Multiple Element Interface System is first powered up, one of the two interfaces is designated at random to be the Master interface. The Master's front panel LED light will be green while the Slave's front panel LED light will be blue (if the Slave interface LED is flashing red, check that optical cables are connected as shown above).

Note that only the Master interface has these attributes:

- System clock master
- Main outputs configurable for connection to speakers
- Inputs listed first in DAW input lists.

To change the Master device, open the System sidebar, then change the designated interface in the Master Device dropdown.

Inputs and outputs of the two Element interfaces are aggregated in the Apogee Thunderbolt driver, so that both interfaces appear as one audio device named **Apogee Thunderbolt** in your DAW or in OS X System Sound Preferences. To distinguish inputs for each interface, Master input labels include the prefix **A**, Slave input labels include the prefix **B**.

Likewise, Element Control Input settings, Low Latency mixer channels, and Main/Headphone output controls are labelled with A and B prefixes to distinguish Master and Slave software controls.

Once two Element interfaces have been connected, Element Control retains data from both, even if one of the interfaces is later disconnected. This means that even if one interface is missing, the I/O detected by your DAW and OS X remains consistent, plus all previously saved Snapshots remain compatible.

Disconnected interfaces appear as "offline" devices; all settings in Element Control pertaining to an offline device appear in a greyed out state.



To permanently delete an offline device, open the Device sidebar and click on the Trashcan icon at the bottom of the offline device's settings.

Additional Support

For more information

- Apogee KnowledgeBase and FAQs
- Informational Videos
- Apogee Product Registration
- How to contact Apogee Technical Support

Please visit:

www.apogeedigital.com/support